

EN

Installation and Operating Manual

Heatless Regenerated Dryer

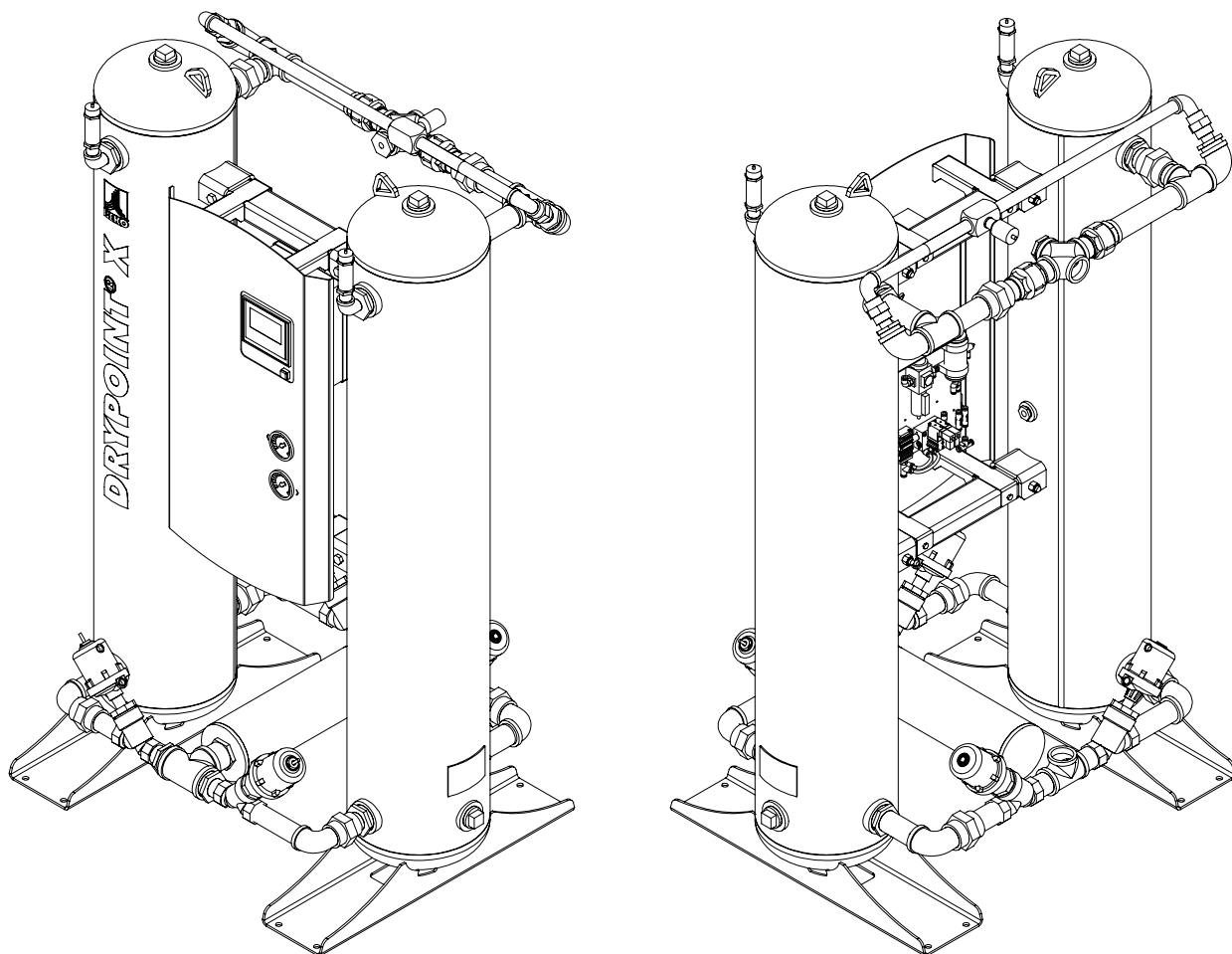

DRYPOINT® XC Premium Series

XCp models 80 to 800 with BEKOTOUCH Controller

READ MANUAL FIRST BEFORE INSTALLATION AND OPERATION



Contents















1. SAFETY AND SYSTEM PRECAUTIONS	3
1.1 Definition of the Safety Symbols	3
1.2 Operational Warnings	3
2. INSPECTION AND INSTALLATION	4
2.1 Incoming Inspection and Transportation	4
2.2 Design and Use of the Dryer	4
2.3 Location and Installation	4
2.4 Mounted Filters with Bypass	6
3. TECHNICAL SPECIFICATIONS AND GENERAL FUNCTION	7
3.1 Technical Data by Model Size	7
3.2 Correction Factors	8
3.3 General Function	8
3.4 Flow Diagram	9
3.5 Cycle Operation	10
4. PURGE VALVE ADJUSTMENT	11
5. START-UP	12
5.1 Verification Prior to Start-up	12
5.2 Start-up Procedures	13
5.3 General Operation	14
6. ISOLATION AND SHUT DOWN PROCEDURES	14
7. STANDARD AND OPTIONAL FEATURES	15
7.1 Humidity Control	15
7.2 Dewpoint Demand	15
7.3 Cycle Type Selection	15
7.4 Time Cycle Selection	16
7.5 Failure to Switch	16
7.6 Filter Contamination	16
7.7 Drain Alarm	16
7.8 Compressor Synchronization	16

8. CONTROLLER INFORMATION AND OPERATION	17
8.1 Display Overview	17
8.2 Controller Setup	18
8.3 HOME Screen	19
8.4 Controller SETTINGS	22
8.5 ALARM HISTORY	23
8.6 HISTOGRAM	25
8.7 Compressor Sync	25
8.8 Power Requirements	26
8.9 Network Connection	26
9. MAINTENANCE AND SERVICE	27
9.1 Routine Maintenance	27
9.2 Maintenance and Service Intervals	28
9.3 Fuses	28
9.4 Desiccant Replacement	29
9.5 Inlet and Exhaust Valve Repair	29
10. TROUBLESHOOTING GUIDE	30
11. MAINTENANCE AND SPARE PARTS	33
11.1 Required Maintenance Parts	33
11.2 Spare Parts	35
12. DISMANTLING OF THE DRYER	36
13. GENERAL DESCRIPTION OF PARTS	37
APPENDX: (Note: one or more of the following may apply)	
Electrical Wiring Diagram	
Process & Instrumentation Diagram	
Sales / General Arrangement Drawing	

For technical product support please call +1 (800) 235-6797 and select Option 2

1. SAFETY AND SYSTEM PRECAUTIONS

1.1 Definition of the Safety Symbols

					
Before attempting any service, please read the manual	General Warning: Risk of damage or injury	Electrical Hazard: Possibility of electro-cution	Warning: Under pressure	Warning: High temperature	Warning: Non-breathable air
					
Warning: Water cannot be used to extinguish fire	Warning: Do not operate if parts are missing or have been tampered with	Warning: Machine level noise may exceed 85 dBA	Warning: Personal protection required	Warning: All work to be performed by qualified personnel only	Operations that can be performed by qualified operators ¹
					
Compressed air inlet connection		Compressed air outlet connection		Connection point for condensate drain	

¹ Only experienced and trained personnel familiar with all of the relevant laws, rules and regulations, capable to perform the needed activities and to identify and avoid possible dangerous situations while handling, installing, using and servicing the machine.

1.1 Operational Warnings

WARNING: VESSELS UNDER PRESSURE



- + In most countries, states, cities and/or local municipalities the installation, operation and maintenance of devices where pressure vessels are in use are subject to local boiler and pressure vessel regulations.
- + The end user is responsible for following all of the relevant laws, rules and regulations and ensuring that only experienced and trained personnel install and/or operate the dryer.
- + In most countries, states, cities and/or local municipalities the installation may only be carried out by a licensed installation company. Inspections must be carried out by a qualified and licensed third-party firm in accordance with all applicable laws, rules and regulations for the region where the dryer is installed.
- + The pressure vessels used in this device are built according to the American Society of Mechanical Engineers (ASME) standard Section 8, Division 1.

Compressed Air Warning:



- Compressed air is a highly dangerous energy source.
- + Never work on the dryer while components are under pressure.
 - + Never point the compressed air stream or the condensate drain outlet towards anybody.

The end user is responsible for the installation of the dryer as laid out in this manual. If proper commissioning steps are not followed, the warranty will be void and dangerous situations involving injury or death and/or damages to the machine could occur.



- Only qualified personnel can use and service electrically powered devices. Before attempting any maintenance:
- + Ensure that no part of the machine is powered and is locked out of the electrical mains by following proper "Lock-out, Tag-out" procedures and requirements.
 - + Ensure that no part of the dryer is under pressure by isolating the dryer from the compressed air system.



Any change to the machine or to the standard operating parameters (see page 5), if not previously verified and authorized by the manufacturer, in addition to creating a potentially dangerous situation, will void the warranty.



Don't use water to extinguish fire on the dryer or in the surrounding area.

2. INSPECTION AND INSTALLATION

2.1 Incoming Inspection and Transportation

All dryers are tested and inspected at the factory prior to shipping. Thoroughly inspect and verify the integrity of the packaging upon receipt and note any damage on the freight bill. Place the unit as close as possible to the installation point before unpacking the contents and inspect for concealed damage. Freight claims are to be filed with the carrier immediately and the manufacturer's technical service department notified thereafter.

- + To move the packaged unit, we suggest the use of a suitable crane or forklift. We do not recommend moving the unit by any hand operated or manual mechanism.
- + Handle with care. Heavy blows could cause irreparable damage.
- + Even when packaged, keep the machine protected from severe weather.



The packaging materials are recyclable. Each material must be properly disposed in a manner complying with the rules and regulations of the local municipality government.

2.2 Design and Use of the Dryer

This dryer has been designed, manufactured and tested to be used only to separate the humidity normally contained in compressed air; any other use is considered to be improper. The manufacturer is not responsible for any problems arising from the improper use of this machine.

The end user, in any and all cases, is responsible for any resulting damages.

Moreover, the correct use of this machine requires the verification of certain installation conditions, in particular:

- + Voltage and frequency of the electrical power supplied
- + Pressure, temperature, flow rate and chemical composition of the incoming compressed air
- + Ambient temperatures

The dryer is supplied as tested and fully assembled. The only operation left for the end user is the connection to the plant air and adjustment of the purge rate in compliance with the instructions given in this manual. Factory settings are at nominal conditions at 100 psig and the stated model flow rate (see sect. 3).



The purpose of the machine is the separation of water vapor that is present in compressed air. It is not intended to separate oil or other contaminants that are present in compressed air. The dried compressed air output from this dryer cannot be used for respiration purposes of any kind.

2.3 Location and Installation



Serious consideration should be given when selecting the installation site for the dryer, as an improper location could directly affect the proper operation of the dryer.

This unit is not suitable to be used in explosive atmospheres, where risk of fire could exist, in the presence of gaseous or solid pollutants or in outdoor applications or areas exposed to the elements.



Do not use water to extinguish fire on the dryer or in the surrounding area.



Machine level noise could be higher than 85 dBA. Install the unit in a dedicated area where people are not normally present. The installer and/or end user is responsible for the correct installation of the dryer in order to prevent excessive noise exposure in the work environment. The installer and/or end user is responsible to install proper safety signs at the installation site.



Technicians that service the machine must wear hearing and eye protection while servicing the dryer. Each employee must select a proper personal protection device (PPD) hearing protector such as earmuffs, ear canal caps or earplugs in order to prevent permanent hearing damage or loss.

Minimum Installation Requirements:

- + Select a clean, dry room that is free of dust and protected from atmospheric disturbances.
- + The equipment foundation must be smooth, horizontally level, able to bear the weight of the dryer and vibration free
- + Minimum ambient temperature of +40 °F
- + Maximum ambient temperature of +120 °F
- + Allow a clearance of at least 3' on all sides of the dryer in order to easily facilitate all maintenance needs
- + The dryer is required to be anchored to the supporting surface
- + Coalescing pre-filter with drain must be installed
- + The location of an air receiver tank will vary depending on compressor type and application conditions



Incorrect installation may void warranty.

NOTE: All piping and electrical connections should be inspected prior to installation to ensure they have maintained their integrity during shipping and locating the dryer.

First, make the initial connections as follows:



1. Inlet piping including an isolation valve
2. Outlet piping including an isolation valve
3. Coalescing pre-filter and particulate post-filter



We recommend the dryer be installed with a 0.01 micron CLEARPOINT® coalescing pre-filter at the inlet and a 1.0 micron CLEARPOINT® particulate post-filter at the outlet. It is recommended to install both 5.0 micron and 1.0 micron filters upstream of the dryer in order to maintain the operational lifespan of the inlet filter to the dryer. In addition, we recommend the use of a BEKOMAT® zero air loss drain on the pre-filter and at all other condensate collection points, especially those upstream of the dryer.

Locate the coalescing pre-filter as close to the dryer as possible while still maintaining sufficient space for routine maintenance and service. Inlet air entering the dryer must pass through a coalescing pre-filter in order to remove entrained condensate and oil to prevent fouling of the desiccant and maintain standard operation. Any liquid condensate entering the desiccant bed will lead to overloading of the dryer, poor dew point performance and rapid deterioration of the desiccant material. Any oil entering the desiccant bed may permanently reduce the capacity of the desiccant material.

Desiccant dust traveling downstream of the dryer may cause contamination and/or accelerated wear to other components and equipment. Therefore, a particulate post-filter should be provided to prevent desiccant dust from traveling downstream. Activated alumina is considered a nuisance dust and proper precautions should be taken when handling desiccant (refer to applicable SDS sheet).



4. **IMPORTANT!** Bypass piping is necessary. Only bubble tight valves should be used.
5. Make the required electrical connections; please refer the type plate of your dryer. The end user is responsible for providing short circuit protection for the dryer.
6. Points of access should be provided upstream and downstream of the dryer for periodic monitoring of dew point, pressure and temperature prior to finalizing the installation. Taking periodic dew point measurements just downstream of the dryer gives the best indication of whether the dryer is performing optimally. We recommend using METPOINT® instrumentation to ensure accurate measurements.
7. All piping must be adequately supported and at least of equal size to the dryer connections.



Before any attempt is made to operate the dryer, the operator must thoroughly read and understand this installation and operation manual.

Optimal Installation Diagram

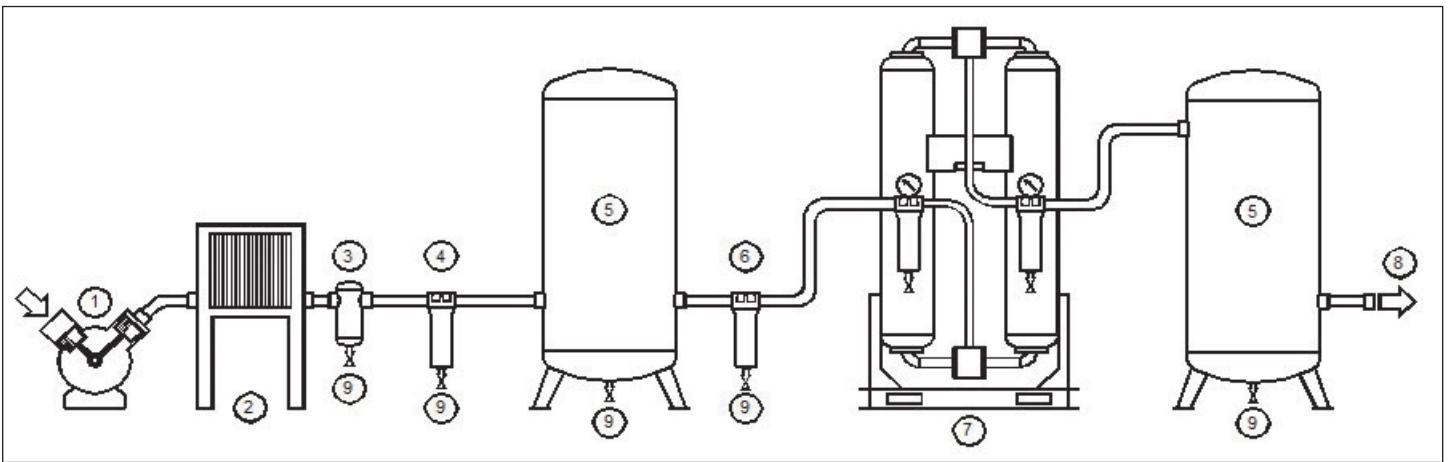

1	Air Compressor
2	After Cooler
3	CLEARPOINT® In-line Water Separator
4	CLEARPOINT® 5.0 Micron (Grade G) Filtration
5	Receiver Tank
6	CLEARPOINT® 1.0 Micron (Grade F) Filtration
7	DRYPOINT® XCp Desiccant Dryer with CLEARPOINT® Pre and Post-filtration
8	Dry Air Outlet
9	Condensate Drainage Points for BEKOMAT®

Optimal installation is with moderately-sized receivers at the inlet and outlet side of the dryer. This allows for the additional free cooling and moisture collection and more consistent dryer inlet flow provided by an upstream receiver, while providing the most reliable shop air supply due to the downstream receiver.

Under no circumstances should the peak demand air flow exceed the maximum rated air flow of the dryer.



We recommend the dryer be installed with a 0.01 micron CLEARPOINT® coalescing pre-filter at the inlet and a 1 micron CLEARPOINT® particulate post-filter at the outlet. It is recommended to install both 5 micron and 1 micron filters upstream of the dryer in order to maintain the operational lifespan of the inlet filter.

2.4 Mounted Filters with Bypass

Mounted Filters with Bypass is an optional setup for DRYPOINT XC. The three valve system bypass allows for the flow of air to be uninterrupted while servicing or completing preventative maintenance such as:

- + Exchange pre- and post- filters
- + Services exhaust silencers
- + Change desiccant

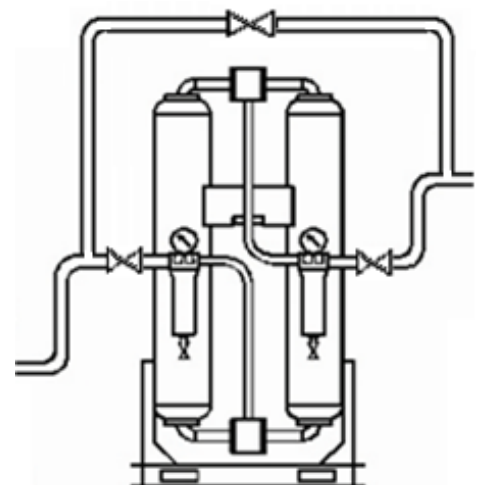

3. TECHNICAL SPECIFICATIONS AND GENERAL FUNCTION

3.1 Technical Data by Model Size

DRYPOINT® XCp	Model Size	80	100	120	160	200	250	300	400	500	650	800
Flow Rate	scfm	80	100	120	160	200	250	300	400	500	650	800
Inlet / Outlet Connection	in. (NPT-F)	¾	1	1	1 ¼	1 ¼	1 ½	1 ½	2	2	2 ½	2 ½
Height (A)	in.	54	64	64	68	68	69	69	71	73	74	71
Width (B)	in.	37	38	38	40	40	45	45	49	53	57	61
Depth (C)	in.	22	23	23	26	26	30	30	35	36	40	43
Adsorbent Material	Activated Alumina	1/8"										
Total per Dryer	Lbs.	132	167	167	262	262	384	384	539	715	917	1114
Outlet Pressure Dew Point	°F	-40										
Minimum Ambient Temperature	°F	40										
Maximum Ambient Temperature	°F	120										
Standard Inlet Air Temperature	°F	100										
Maximum Inlet Air Temperature	°F	120										
Minimum Air Pressure	psig	60										
Standard Air Pressure	psig	100										
Maximum Air Pressure	psig	150										

Optimal installation is with moderately sized receivers at the inlet and outlet side of the dryer. This allows for the additional free cooling and moisture collection and more consistent dryer inlet flow provided by an upstream receiver, while providing the most reliable shop air supply due to the downstream receiver.

Under no circumstances should the peak demand air flow exceed the maximum rated air flow of the dryer.

Dryer ratings adhere to the following inlet conditions per ISO 7183, Table 2, Option A2:



- + Inlet Compressed Air Temperature 100 °F (38 °C)
- + Inlet Compressed Air Pressure 100 psig (7 bar)
- + Maximum Ambient Air Temperature 100 °F (38 °C)
- + Inlet Compressed Air Relative Humidity 100% (Saturated)

SCFM is defined as the volume of free air in cubic feet per minute measured at 14.5 psia (1.013 bar) at 68 °F (20 °C) temperature with 0% relative humidity (0 WVP).

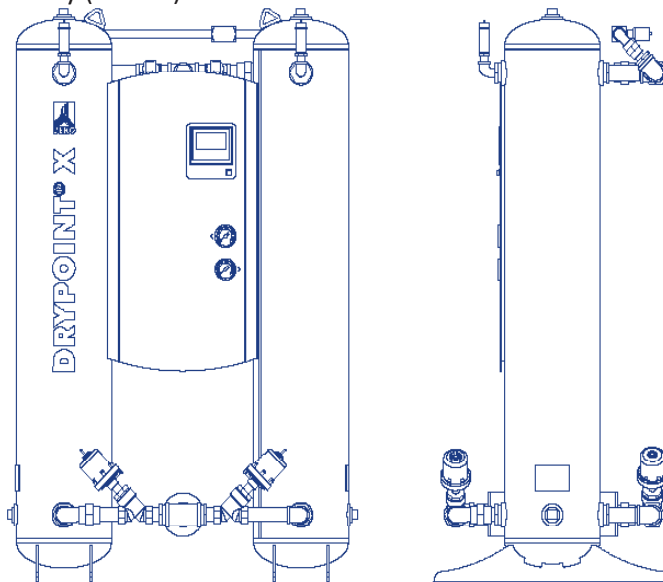

3.2 Correction Factors

Correction Factors							
	≤ 90°F	95°F	100°F	105°F	110°F	115°F	120°F
60 PSIG	0.70	0.68	0.65	0.60	0.55	0.50	0.46
70 PSIG	0.79	0.77	0.74	0.68	0.62	0.57	0.52
80 PSIG	0.88	0.85	0.82	0.75	0.69	0.63	0.57
90 PSIG	0.97	0.95	0.91	0.84	0.76	0.70	0.64
100 PSIG	1.07	1.04	1.00	0.92	0.84	0.77	0.70
110 PSIG	1.17	1.13	1.09	1.00	0.92	0.84	0.76
120 PSIG	1.25	1.22	1.17	1.08	0.98	0.90	0.82
130 PSIG	1.31	1.27	1.22	1.12	1.02	0.94	0.84
140 PSIG	1.34	1.30	1.25	1.15	1.05	0.96	0.88
150 PSIG	1.39	1.35	1.30	1.20	1.09	1.00	0.91

How to Determine Dryer Capacity at Operating Conditions:

ADJUSTED CAPACITY =
Standard Flow Rate x Correction Factor

Example:

Dryer Model: DRYPOINT® XCp 250
Standard Flow Rate: 250 scfm
Operating Conditions: 110 psig / 110 °F
ADJUSTED CAPACITY = 250 scfm x 0.92 = **230 scfm**

How to select the dryer for actual conditions:

ADJUSTED CAPACITY =
System Flow Rate ÷ Correction Factor

Example:

System Flow Rate: 300 scfm
Operating Conditions: 130 psig / 100 °F
ADJUSTED CAPACITY = 300 scfm ÷ 1.22 = **246 scfm**
Select Dryer Model: DRYPOINT® XCp 250

3.3 General Function

The DRYPOINT® X heatless desiccant dryer series are fitted with two pressure vessels, positioned parallel to one another and filled with adsorption material (1/8" activated alumina as standard). While the compressed air is dried in one tower, the saturated desiccant is regenerated in the second. A minimal portion of the treated air is used for the regeneration process and expelled along with the condensate, through the silencers.

The saturated inlet air is cycled through each of the two desiccant beds in an alternating sequence where one bed is on-line at full line pressure and flow, adsorbing the water vapor. This is the drying bed.

The other bed is then considered to be in an off-line state at atmospheric pressure and is being regenerated by a depressurized portion of the dried, treated outlet air (purge air). This is the regenerating bed.

The purge air is routed from the dry outlet air through the purge flow control valve, desiccant bed, purge exhaust valve and finally exhausted to atmosphere through silencers to finish the regeneration process. Purge air consumption is generally the highest cost involved with operating a heatless adsorption dryer and is non-recoverable. Therefore, the air system where the dryer is installed must account for this usage (approximately 15% of the inlet air flow).

Just before the freshly regenerated bed is brought to an on-line state to become the drying bed, it is slowly pressurized from atmospheric pressure up to line pressure. This is the re-pressurization step that prevents desiccant bed fluidization (bed lifting) and dusting. The desiccant beds will now switch functions where the fresh desiccant bed is now drying and the saturated bed is now regenerating.

This cycle will continue automatically unless the dryer is shut down.

All desiccant dryers work using the principle of adsorption, which is the process by which water vapor is removed from the compressed air being dried. All desiccant material types are adversely affected by contaminants including oil,

aerosols, dirt, rust, scale and liquid water. If contaminated, the desiccant material will lose its adsorption properties.

During normal operation, the desiccant will release a small amount of dust (as fine powder) that is particularly abrasive and can be extremely damaging to downstream components and users.

For this reason, it is highly recommended that the dryer is equipped with two high-efficiency CLEARPOINT® filters:

- + **0.01 micron** filtration grade coalescing **pre-filter** with differential pressure gauge and either a float drain or BEKOMAT®
- + **1.0 micron** filtration grade particulate **post-filter** (differential gauge optional) and with a manual drain.

3.4 Flow Diagram (Note: refer to P&ID in Appendix, if applicable)

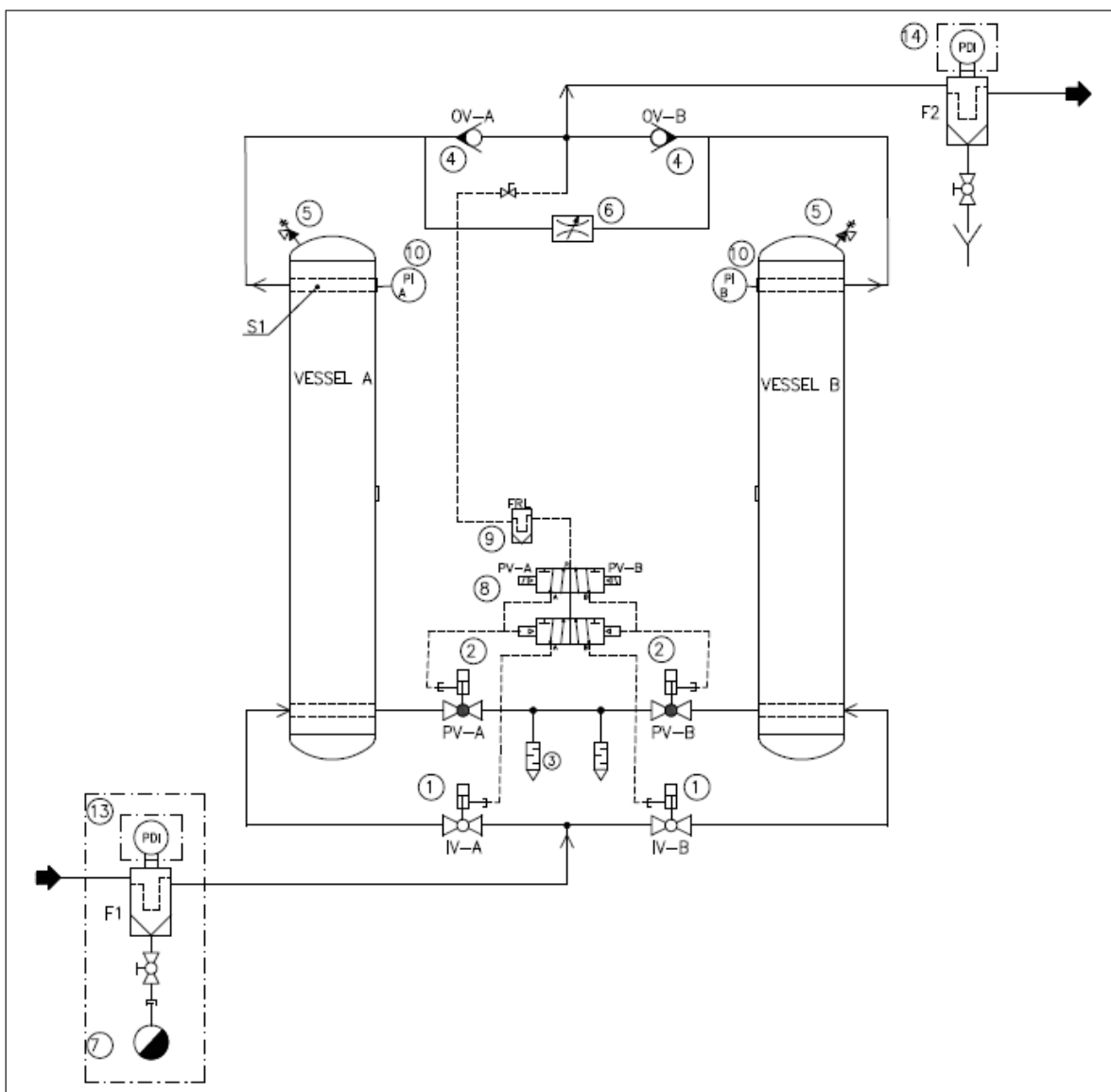

Number	Name
1	Inlet Valve (Normally Open)
2	Purge Exhaust Valve (Normally Closed)
3	Exhaust Silencer
4	Outlet Check Valves
5	Pressure Relief Valve
6	Purge Control Valve
7	BEKOMAT Zero Loss Drain

Number	Name
8	Solenoid Block
9	Pilot Air Filter and Regulator
10	Vessel Pressure Gauge
11	Dew Point Sensor (Optional)
12	Energy Management System %RH
13	Pre-filter with Float Drain
14	Post-filter with Manual Drain

3.5 Cycle Operation

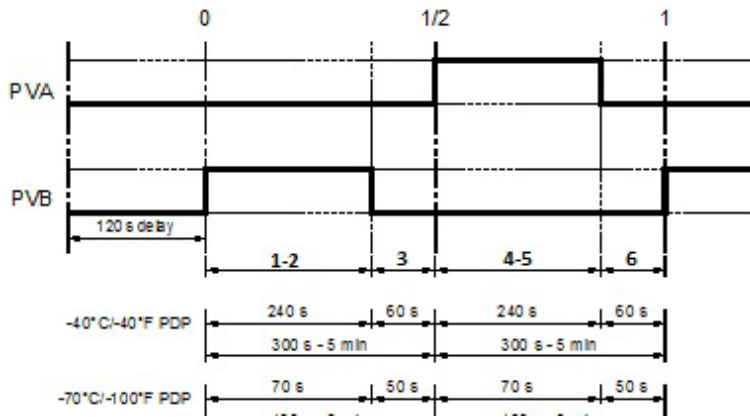

The cycle time is factory set for operation at 100 psig inlet air pressure and 100 °F inlet air temperature.

+ 10 minutes for -40 °F (-40 °C)

IV-A = Inlet Valve, Vessel A

IV-B = Inlet Valve, Vessel B

PV-A = Purge Valve, Vessel A

PV-B = Purge Valve, Vessel B

Pressurization Sequence

After proper pressurization of the dryer the operator may begin the start-up. During the start-up phase, both purge exhaust valves PVA and PVB (5 and 6) are closed for a period of 70-seconds to help guarantee the complete pressurization of the dryer.

- Step 1-2** The purge exhaust valve PV-B (2) is powered open to depressurize vessel for regeneration. Simultaneously the solenoid valve IV-B (1) is powered closed by the pneumatic tower selection. The compressed air flow is directed to vessel A, where the desiccant material adsorbs the humidity down to the target dew point. Through the purge control valve (6) a set amount of dry air discharged from tower A is expanded into vessel B. This dry air, while crossing vessel B, dries the adsorbent material and the now moisture-laden purge air is discharged through the PV-B valve (2) and exits the silencers (3). At the end of this stage the adsorption material of vessel B is completely regenerated.
- Step 3** The purge exhaust valve PV-B (2) is closed and then through the Purge Control Valve (6) vessel B is re-pressurized to the working pressure. The sum of stages A + B equals a half cycle time.
- Step 4-5** The purge exhaust valve PV-A (2) is powered open to depressurize vessel for regeneration. Simultaneously the solenoid valve IV-B (1) is powered closed. The compressed air flow is directed to vessel B, where the desiccant material adsorbs the humidity down to the target dew point. Through the purge control valve (6) a defined amount of dry air coming out from tower A is expanded into vessel B. This dry air while crossing vessel A, dries the adsorbent material dragging away the humidity through the PV-A valve (2) and the silencers (3). At the end of this stage the adsorption material of vessel A is completely regenerated.
- Step 6** The purge exhaust valve PV-A (8) is closed and then through the Purge Control Valve (6) vessel A is re-pressurized up to the working pressure. The sum of stages C + D equals a half cycle time. At the end, the cycle starts up again from Stage A.

NOTE: The cycles are symmetrical, therefore 1-2=4-5 and 3=6

4. PURGE VALVE ADJUSTMENT

The purge flow control valve must be set to match the inlet pressure of the dryer. The valve must be opened to the corresponding number of turns referenced in the table below.

- + Always base the pressure adjustment on the lowest operating pressure of the system
- + The initial setting from factory is for 100 psig operation

The procedure for adjusting the purge flow control valve is as follows:

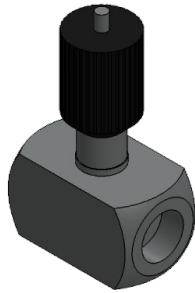

Rendered drawing of purge flow control valve



Turn knob clockwise (to the right) to close



Turn knob counter clockwise (to the left) to open

The knob stem of the valve is numbered and a complete turn is considered turning the control knob 360° from number to number. The number of turns expressed in the table below is based on the number of turns from the closed position.

1. Loosen the screw using a flathead screwdriver or allen-head
2. Turn the purge flow control valve clockwise until the stopping point – the valve is now closed
3. Turn the purge flow control valve counter clockwise until the setting for the desired operating pressure value is reached – the valve is now open
4. Tighten the screw using a flathead screwdriver or allen-head

Purge Adjustment Table

Approximate Purge Valve Setting (number of turns to open)

Dryer	Purge Flow Rate [scfm]	Dryer Inlet Pressure				
		80 psig	90 psig	100 psig	110 psig	115 psig
XC 80	16	3.5	3.2	3.1	2.9	2.9
XC 100	20	4.0	3.8	3.7	3.6	3.5
XC 120	24	5.5	5.3	5.0	4.8	4.5
XC 160	32	5.9	5.7	5.5	5.4	5.4
XC 200	40	6.5	5.6	5.2	4.8	4.7
XC 250	50	7.0	6.5	6.0	6.0	5.5
XC 300	60	8.0	7.5	7.1	6.9	6.8
XC 400	80	3.6	3.5	3.3	3.2	3.1
XC 500	100	4.5	4.4	4.2	4.1	4.0
XC 800	160	6.2	4.9	4.7	4.6	4.5

Consult a factory representative for more information.

5. START-UP

5.1 Verification Prior to Start-up



Verify that the operating parameters match with the acceptable ranges indicated on the data plate of the dryer (voltage, frequency, air pressure, air temperature, ambient temperature, etc.). This is not the same as the ASME UW plate on the vessels and may be lower than what is stamped on the ASME UW plate.

Before delivery, each dryer is submitted to accurate tests simulating real operating conditions. Nevertheless, the unit could be damaged during transportation. Therefore, we suggest checking the integrity of the dryer upon arrival (see page 4) and observing the dryer during the first hours of operation.



The start-up must be performed by qualified personnel only. It is mandatory that the qualified person in charge will verify safe operational conditions complying with the local safety and accident prevention requirements.



The same qualified person will be responsible for the proper and safe operation of the dryer. Never operate the dryer if all panels are not properly in place or if any componentry is missing or appears damaged.



Service to be performed by qualified personnel only. The end user is responsible to ensure that the dryer will never be operated with pressure that exceeds the maximum pressure rating of the unit. Operating the dryer at a pressure higher than the maximum rating could be dangerous for both the operator and the machine.

The inlet air temperature and air flow rate entering the dryer must be within the limits indicated on the data plate.

Installation precautions must be taken in order to limit the vibration that can occur during the operation of the dryer. Therefore, we recommend using flexible connecting pipes that are able to insulate the dryer from possible vibrations originating from the pipe line.



The connection to the main power is to be carried out by qualified personnel, and the safety protocol must comply with local rules and laws.

Before connecting the unit to the electric power, verify that the voltage and the frequency available on the mains correspond to the data on the data plate of the dryer. In terms of voltage, a $\pm 5\%$ tolerance is acceptable. The wire size feeding the dryer must comply with the consumption of the dryer, while keeping into account also the ambient temperature, the conditions of the main power junction box, the length of the wire, and the requirements enforced by the National Electric Code.



It is mandatory to ensure the connection to the ground terminal.



The condensate is discharged at the same pressure as the air entering the dryer. Never point the condensate drain discharge towards anybody.

Connect and properly fasten the condensate drain to a collection system or container. The outlet condensate hose cannot be connected to pressurized systems.

DO NOT DISPOSE OF CONDENSATE INTO THE ENVIRONMENT



The condensate collected in the dryer contains oil particles released into the air stream by the compressor. Dispose of the condensate in a manner compliant with all local, state and Federal rules and regulations. We highly recommend the installation of either a QWIK-PURE® or ÖWAMAT® oil-water separator at the final collection point for all condensate discharge lines within the facility (i.e. from the main header).

5.2 Start-up Procedures



During the first start-up or start-up after a long period of inactivity or following maintenance, the technician must comply with the instructions below. The start-up must be performed by qualified personnel only.



The employee that operates the machine must wear hearing and eye protection before operating the dryer. Each employee must select a proper personal protection device (PPD) hearing protector such as earmuffs, ear canal caps or earplugs in order to prevent permanent hearing damage or loss.

Start-up Sequence

- + Please read and understand the entire manual before operating the dryer
 - + Verify the factory settings
 - + Verify the wiring diagrams that pertain to your unit and ensure the correct power supply is connected
- Do not energize the circuit at this time**
- + Verify that proper short circuit protection has been provided following all applicable codes and regulations
 - + Verify that all the steps of in the previous chapters relating to installation have been observed
 - + Verify that the connection to the compressed air system is correct
 - + Verify that the condensate drain pipe is properly fastened and connected to a collection system or container
 - + Remove any packaging and other material that might obstruct the area around the dryer

Before starting the dryer your compressor should be running, your compressed air system pressurized and the dryer bypassed and not yet pressurized.



1. With the dryer bypassed and in isolation (see page 14)
2. **SLOWLY** open the inlet isolation valve allowing compressed air into the dryer. It is critical that the dryer be pressurized slowly to prevent fluidization of the desiccant bed. Keep the outlet isolation valve closed at this time.
3. **SLOWLY** open the outlet isolation valve. All valves are now in their open positions and compressed air is flowing through both towers and downstream.
4. Close the dryer bypass valve. The bypass valve must be bubble tight to prevent any moisture from contaminating the dry air outlet from the dryer.
5. Plug in the dryer and energize the electrical circuit – the dryer is now ON.
6. Verify that the controller is on.
7. Check all piping for compressed air leaks.
8. Test the condensate drain on the pre-filter.
9. After 1-minute from start-up the adsorption tower B will be depressurized.
10. Wait for the dryer to make 10 full cycles (i.e. the depressurization from tower A to tower B).
11. The dryer will make the first 5 cycles short cycles, running at 50% run time without regard for dew point.
12. The pressure swing cycles occurs, every 5 minutes (outlet dew point of -40°F).

NOTE: During the first days in operation, the dew point cannot be guaranteed because the adsorption material can contain humidity from storage. At the first start-up or start-up after a long inactivity period or following maintenance shutdowns, we recommend operating the dryer at a reduced nominal flow of 50% during the first two days.

5.3 General Operation

- + The dryer may require up to 48-hours of operation to reach normal operating outlet dew point. Therefore, indicators and alarms do not need to be recognized during this time. Applications where a dew point lower than -40 °F is needed, may require additional time to reach equilibrium.
- + The dryer will not perform without properly sized and installed pre-filtration, condensate drainage and correct purge flow adjustment.
- + After the initial start-up some dusting may occur. This is normal and will diminish with time, although may accelerate the first maintenance interval of the exhaust valves, exhaust silencers and post-filter element.
- + Exhaust valves and silencers may have to be cleaned due to dusting from shipping and the initial start-up, and should be cleaned regularly to ensure proper operation. Post-filter elements should also be part of a regular preventative maintenance schedule.
- + Never service the dryer or filters without first relieving pressure from the dryer.
- + A desiccant dryer should never be pressurized or depressurized suddenly. This will cause degradation and dusting of the desiccant bed.
- + The dryer is designed for a maximum operating pressure of 150 psig as standard.

6. ISOLATION AND SHUT DOWN PROCEDURES



Users operating the machine must wear hearing and eye protection. Each employee must select a proper personal protection device (PPD) hearing protector such as earmuffs, ear canal caps or earplugs in order to prevent permanent hearing damage or loss.



Isolation

1. Allow the dryer to reach its re-pressurization step and fully re-pressurize.
2. Once fully re-pressurized, remove power from the dryer.
3. Open the bypass valve.
4. Close the outlet isolation valve.
5. Close the inlet isolation valve.



Depressurization and Shut Down

1. Open the bypass valve.
2. Close the outlet isolation valve.
3. Close the inlet isolation valve.
4. Allow the dryer to continue to run. During the normal operating cycle both towers will blow down and depressurize.
5. Disconnect the power to the dryer.
6. Open the manual ball valves on any filters with manual ball valves to allow full depressurization. Also, leave manual ball valves on filter open during maintenance and service.



IMPORTANT! Always remove all pressure and disconnect all power before servicing the dryer.



To restart the dryer, follow the start-up procedure in Section 5. START-UP on pages 12-13.

7. STANDARD AND OPTIONAL FEATURES

7.1 Humidity Control (*Standard*)

Humidity control comes as a standard programmable function on the DRYPOINT® XCp line of dryers providing the unit with an energy management function and to provide early moisture detection within the desiccant bed. The energy management function can be used to save energy for low load hours or during times of year with lower ambient temperatures or pressure dewpoint. The high moisture detection protects the desiccant bed from oversaturation.

Humidity control utilizes a humidity sensor located within a sampling chamber that monitors the mid tower compressed air from of the online drying vessel. The humidity sensor continuously checks the vessel to see if the dryer's desiccant has a moisture level below the humidity control set point. If the humidity is below the set point, the controller program will extend the drying cycle on that vessel thus saving energy by not switching vessels and using purging air. The system controller allows for a maximum of 30 minutes of energy savings per vessel before it is forced to switch in the event a sensor anomaly occurs. If the humidity in the vessel is too high, above the alarm value, it will trigger the system a minor alarm. This feature is to protect the bed from oversaturation and to provide the customer some means of energy savings.

Under partial load conditions there are no adjustment to the target humidity needed.

7.2 Dewpoint Demand (*Optional*)

Dewpoint demand comes as optional programmable function on the DRYPOINT® XCp line of dryers in order to provide the unit with an additional energy management function and real time dewpoint monitoring. The dewpoint monitoring is done through a METPOINT DPM dewpoint polymer sensor located at the outlet of the dryer.

Dewpoint control is the target dew point of the dryer; the factory setting and recommendation is -45F. Below this value, the controller program will work alongside humidity control to provide energy saving with the dryer. The dewpoint alarm is the setting at which the controller will go into alarm if the value goes above that number; the factory setting and recommendation is -40F. Above this value, the high dewpoint minor alarm will trigger.

Dewpoint demand differs from humidity control in that, dew point demand monitors the outlet performance while humidity control monitors the humidity mid- vessel. While dewpoint demand is a more accurate measurement and measure the dewpoint of air leaving the dryer, when an unacceptably high dewpoint is detected, it is traditionally late to react. Humidity control compensates for this with a fast reaction time in the vessel. The conjunction of the two control features provides the customer an accurate and fast way to provide energy savings with the best performance recovery.

7.3 Cycle Type Selection (*Standard*)

Cycle Type Selection is another system programmable function on the DRYPOINT® XCp dryer line. The control has one of two options: Time Cycle and Energy Management System. Time Cycle control makes the dryer switch at a specific time interval: either 5 min or 10 min (selected under Time Cycle). This selection is used when a defined NEMA cycle is desired. Energy Management System allows the system to enter an extended drying cycle (maximum of 30 minutes). This function can be used where there is variable load demand on the compressed air system throughout the day, i.e. a factory with a constant compressed air demand during first shift however a much lower demand during second and/or third shift. The savings in this function is the elimination of unnecessary purge air used in regeneration of the second tower. For additional information on the system sequence, see Section 7.3 under the sequence step 'Savings'.

7.4 Time Cycle Selection (*Standard*)

Time Cycle is a programmable function for the DRYPOINT® XCp line of dryers under SETTINGS. It has two options: 5 Min Cycle and 10 Min Cycle. This is the total NEMA cycle of the dryer (depending on selection, the unit will complete a full drying cycle which consists of both tower drying). The 10 Min Cycle is the standard mode and should be selected when a dew point of -40 F is desired. The 5 Min Cycle mode should be selected for fast troubleshooting of operation or can be used for special factory consulted applications that can reach much lower desired dew points.

7.5 Failure to Switch (*Optional*)

Failure to Switch feature is provided by monitoring the pressure swing thru the dryer sequence. Each dryer's tower pressure is monitored continuously by pressure transducers that detect the high and low pressure states. The states or conditions are used to verify that each valve has switched accurately in a timely manner during the dryer sequence. If a state is incorrect for too long the switch generates a signal to the PLC providing an alarm to notify the customer of the date and time of the event. This major alarm stops the dryer so that further damage does not occur.

7.6 Filter Contamination (*Optional*)

Filter Contamination is detected for either the Pre or Post filter by using the Clearpoint pressure differential gauge along with electrical contacts. When the pressure differential across the element is too great an electrical signal is generated to the PLC providing a minor alarm message to change the media or check for trouble.

7.7 Drain Alarm (*Optional*)

Drain feature is provided for customer by utilizing the BEKOMAT drain alarm features. The BEKOMAT is able to let the PLC know when it is contaminated, in trouble or simply reached its service interval. The drain thus provides a signal to the PLC generating a minor alarm to notify the customer of the date and time of the event.

7.8 Compressor Synchronization (*Standard*)

The controller has the capability to synchronize the dryer with compressor when the compressor switches ON and OFF. Hence, it prevents a situation where the dryer continues to operate and use purge air from the compressed air network though there is no supply of compressed air. In case the voltage (120V AC-Input) drops at the input, the purge exhaust valves are immediately closed.

After the compressor signal comes back online, the drying cycle is continued from the same point, meaning that the last open valve also opens again. Note two exceptions:

- + This is not valid if the remaining regeneration time is less than 30 seconds, in which case it immediately switches over to the other drying column, which means the other valve is opened.
- + If the compressor is switched off for more than 24 hours, then the device is completely restarted.

8. CONTROLLER INFORMATION AND OPERATION

8.1 Display Overview

The interface between the dryer and the operator is the control panel shown below:



Home Button



Settings



Alarm History



Histogram

The operation of the dryer is controlled and monitored constantly by the advanced system controller. This is a multi-function device:

- + It displays the operating status through the display panel
- + It can be used to select from a fixed time interval or use energy management
- + Chart the relative humidity and dewpoint (optional) of the system
- + Provides and records system alerts

8.2 Controller Start-up

The main power button on the dryer face panel powers the controller. When pressed, the controller startup sequence begins. This includes a system boot process which takes about 60 seconds.

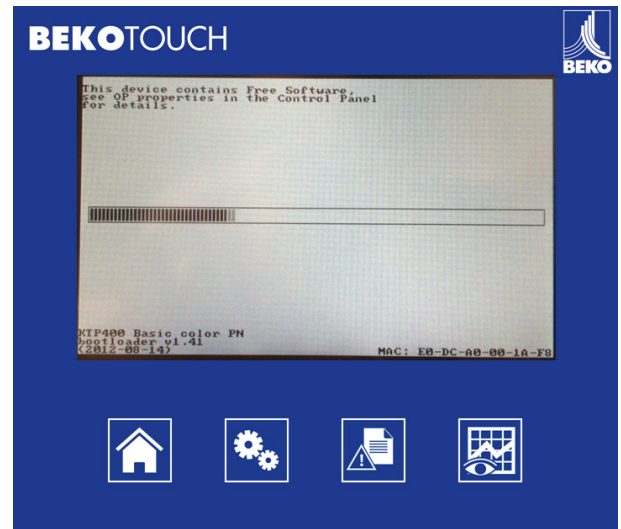

Once the startup sequence is complete. The **START** window will be displayed. This screen allows access to limited system controls; however, it should only be accessed by persons with proper knowledge of its function.



The **START** screen is only displayed for 3 seconds, after which, the **HOME** screen will be displayed and the controller will automatically begin its drying sequence.

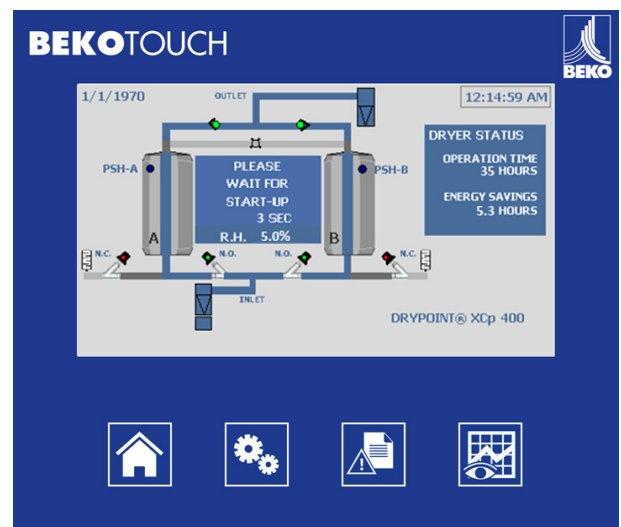

8.3 Home Screen

HOME



After the controller startup, the **HOME** screen dryer operation is displayed. This screen can be accessed at any time by pressing the **HOME** button.

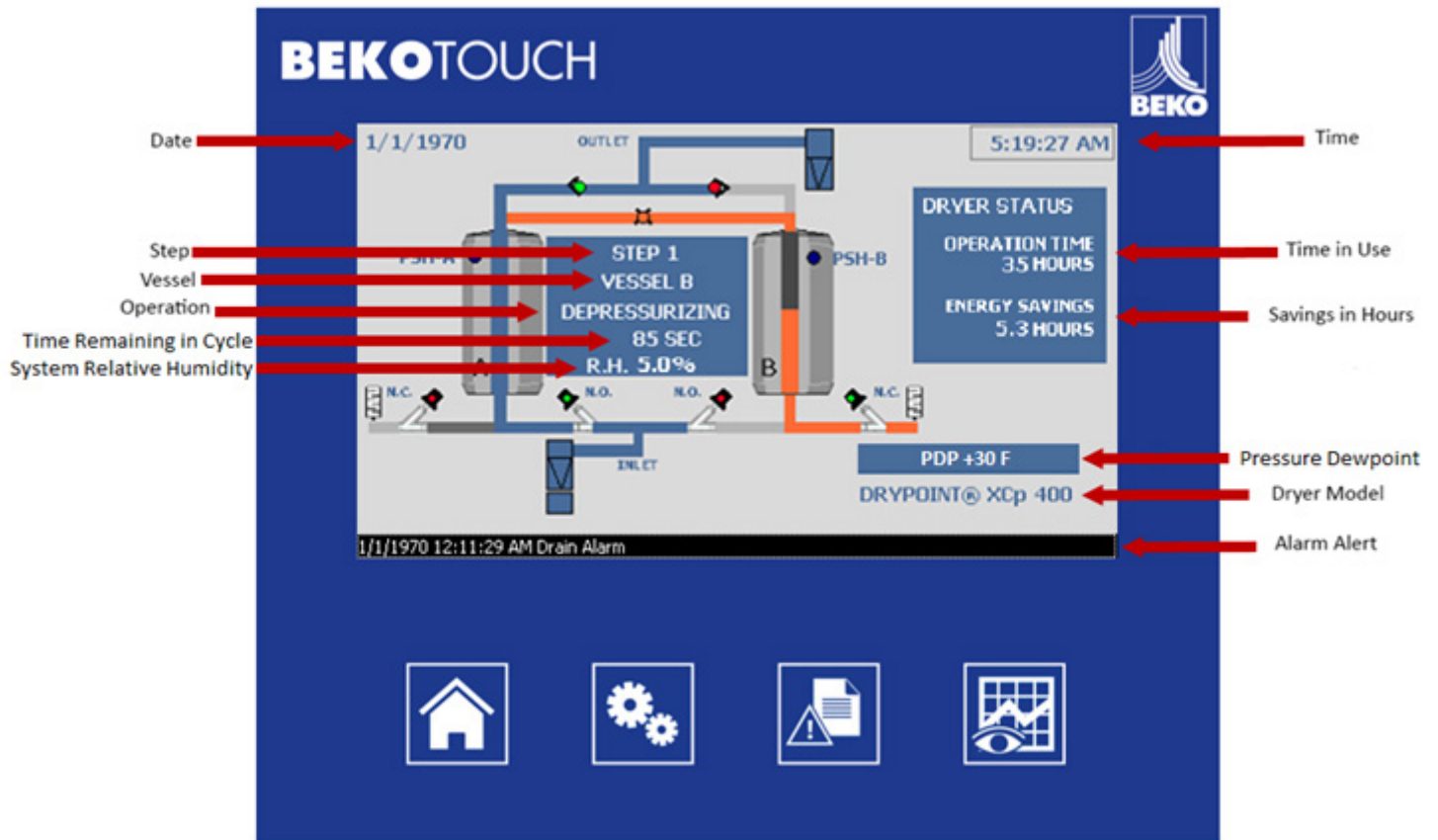

Here, the controller provides the system information along with an animation of the drying process based on the operating sequence it is on. Each step is detailed below along with a screen shot of the process.

Startup: System Start-Up (70 sec.)

- + The controller is evaluating its system parameters to determine the correct step on which to start. The system retains its sequence history, so, in the case of a power interruption, the controller will restart on its last step.
- + At start up, both the exhaust solenoid valves are closed and the compressed air passes through both drying towers.



Step 1: Vessel B De-pressurizing (first 5-10 seconds of Regeneration)

- + Vessel A is in the process of drying system air while vessel B's purge exhaust valve is open thus depressurizing the vessel as the start to the regeneration process.



Step 2: Vessel B Regenerating (240 sec.)

- + While vessel A remains in process of drying the system air, vessel B is using purge air from vessel A's outlet to regenerate the desiccant.

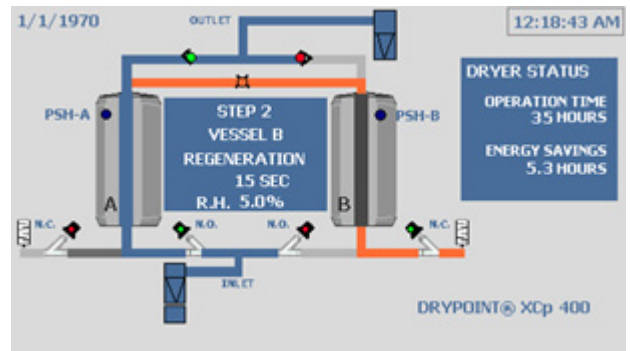

Step 3: Vessel B Re-Pressurize (60 sec.)

- + Vessel A continues the process of drying system air while vessel B's purge exhaust valve closes thus allowing the vessel to re-pressurize.



Savings: Extended Drying (30 min. max)

- + In extended drying, vessel A will continue drying for an extended period of time up to 30 min. maximum or until the moisture control sensor is triggered. At that point, extended drying is terminated and the next step will start.
- + Here, energy savings is calculated in hours and totaled on the screen.

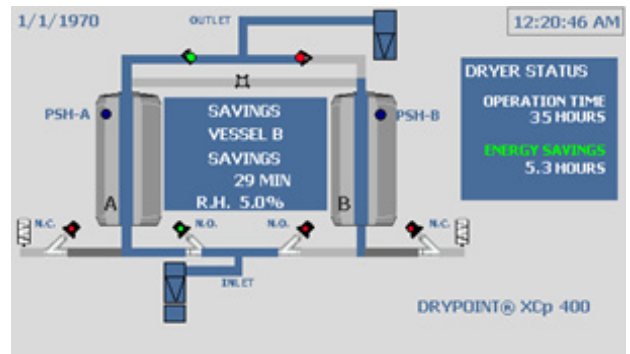

Step 4: Vessel A De-Pressurization

- + This starts the process of drying using the other vessel.
- + Vessel B is in the process of drying system air while vessel A's purge exhaust valve is open thus depressurizing the vessel as the start to the regeneration process.



Step 5: Vessel A Regenerating (240 sec.)

- + While vessel B remains in process of drying the system air, vessel A is using purge air from vessel B's outlet to regenerate the desiccant.



Step 6: Vessel A Re-Pressurize (60 sec.)

- + Vessel B continues the process of drying system air while vessel A's purge exhaust valve closes thus allowing the vessel to re-pressurize.



Savings: Extended Drying (30 min. max)

- + In extended drying, vessel B will continue drying for an extended period of time up to 30 min. maximum or until the moisture control sensor is triggered. At that point, extended drying is terminated and the next step will start.
- + Here, energy savings is calculated in hours and totaled on the screen.

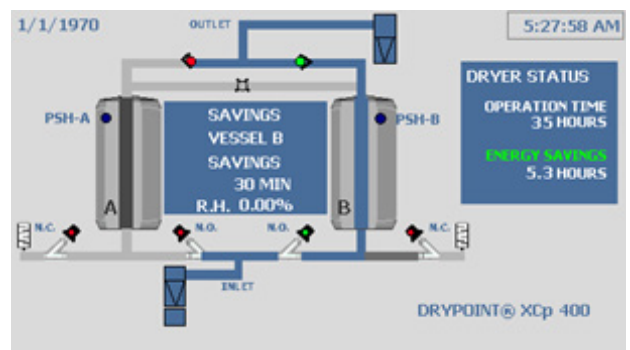

After this second Savings step, the controller will continue back to Step 1. Note that the Savings step function is only applicable if it has been enabled in **SETTINGS** (under the Energy Management option). To enable this, refer to the **SETTINGS** section of the manual.

8.4 Controller Settings

SETTINGS



Within the **SETTINGS** function of the controller, the system can be configured based on several characteristics that will affect the operation of dryer:

- + Humidity Control
- + Dewpoint Demand (Optional)
- + Cycle Type Selection
- + Time Cycle Selection

Humidity control and humidity alarm are displayed on the main **SETTINGS** screen. These values come set from the factory and should only be adjusted if calibration is needed.



Dewpoint demand is a feature that will only be displayed on the main **SETTINGS** screen if the function is activated. The factory setting for dewpoint control and dewpoint alarm is -45F and -40F respectively.

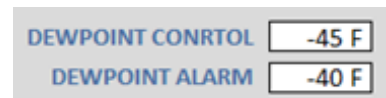

To adjust any of these values, use the touch screen on the controller to select and re-entering a new value via the “Touch Input Panel.”

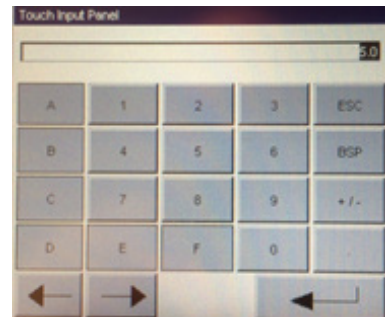

To pick between the two options for Cycle Type Selection, simply use the controller touch screen and tap the Cycle Type Selection button to toggle between: Time Control and Energy Management System. The active selection will be displayed.



To pick between the two options for Cycle Time Section use the controller touch screen and tap the Cycle Time Section button to toggle between: 5 min or 10 min. The active selection will be displayed.



By pressing the **SPARE PARTS** button within **SETTINGS**, an abbreviated spare parts list of the dryer can be accessed. Use the touch screen to access this function to display the spare parts list on a new screen. If a spare part is needed that is not on this list refer to Section 10 of this manual, call your distributor or a BEKO Technologies representative for assistance.

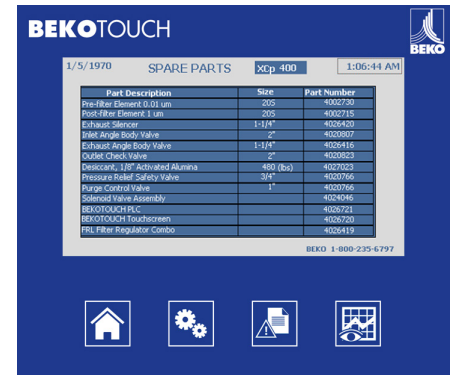

Lastly, in **SETTINGS**, there is an administrative button **ADMIN**. However, this button is locked for use by a BEKO Technologies representative.

8.5 Alarm History



ALARM HISTORY



The controller has ability to continually monitor specific dryer characteristics along with any ancillary equipment provided it is connected to the controller. If there is a functional issue associated with normal operation, an alarm will be triggered and the pop-up ribbon will be displayed on the bottom of the active screen. The alarm types are listed below:

1/1/1970 12:11:29 AM Drain Alarm

Alarm Types



High Humidity Alarm

Occurs when the mid-vessel humidity becomes higher than the desired alarm setting.



High Dewpoint Alarm (Optional)

Occurs when the system outlet dewpoint becomes higher than the desired alarm setting. This function can be activated only if the dew point sensor is installed.



Dewpoint or Humidity Sensor Failure

Each sensor also has a sensor failure feature to help identify faulty probes and default the system into a time cycle.



Drain Alarm

This alarm can only be used if the BEKOMAT® drain is installed. The BEKOMAT® drain can be plugged into the controller and the drain alarm will display on the controller.



Failure to Switch Alarm (Optional)

This alarm continuously monitors the time rate of pressurization and depressurization for each tower through a pressure switch. If the time rate is too slow, the system will set off an alarm.



Pre-filter Filter Contaminated

The system can be setup to monitor the differential pressure measured off the pressure housing electrical switch. When this alarm is activated, it means that the dryer inlet filter is contaminated and therefore it must be replaced. This alarm does not affect the operation of the dryer, but maintenance is needed. Please refer to the user manual of the filter itself.



Post-filter Contaminated

Like the pre-filter, the system can be setup to monitor the differential pressure measured off the pressure housing electrical switch (optional on the post-filter). When this alarm is activated, it means that the dryer post filter is contaminated and therefore it must be replaced. This alarm does not affect the operation of the dryer, but maintenance is needed. Please refer to the user manual of the filter itself.



Filter Maintenance Timer

This service alarm is for when the filters in the flow diagram are flashing at the same time, the timer for the programmed maintenance of the filters has gone off.



Desiccant Maintenance Timer

If the service alarm for the desiccant, the timer for the programmed maintenance of the desiccant material has gone off.

When an alarm is triggered, it will appear on the bottom of the controller screen regardless of the active screen with the date, time and type of alarm. When an alarm is active, it will remain on the screen until it is addressed. To find out additional detail and to address the alarm, go to the **ALARM HISTORY** screen.

On the **ALARM HISTORY** screen all previous alarms are shown along with the current active alarm. The alarms are shown in descending order with the most recent at the top of the screen.

Incoming messages have an 'I' designation immediately following the date and time when the alarm was triggered. Messages that have been acknowledged and addressed have an 'IO' after the date and time indicating the moment in time when the alarm was reset.

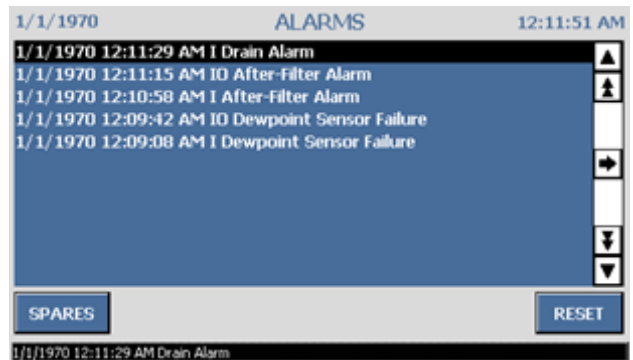

An alarm should only be **RESET** after a corrective action has been taken to address the alarm.

If more than one alarm is triggered use the   arrows to toggle between alarms.

Notices that all past alarms are stored as history in the controller as well as when the alarm was reset.



Please see section TROUBLESHOOTING GUIDE for specific causes and recommended actions to return dryer to proper function.

8.6 Histogram



HISTOGRAM



Pressing **HISTOGRAM** allow a real time trend line of the relative humidity of the dryer. At full **ZOOM +** a total of 80 minutes can be displayed.

To start the histogram and trend data press **START /STOP**. To reset the trend line simple press **RESET**.

The DRYPOINT® XCp has an optional data logging function which stores the relative humidity data. This can be used for example as part of a quality control system.

To toggle between the dewpoint and humidity histogram, press **VIEW DEWPOINT**.

8.7 Compressor Synchronization

The controller has the capability to synchronize the dryer with compressor when the compressor switches ON and OFF. This is detailed in the STANDARD AND OPTIONAL FUNCTION & FEATURES section of the manual. When synchronization occurs and the compressor is OFF, the controller display screen shows this information.

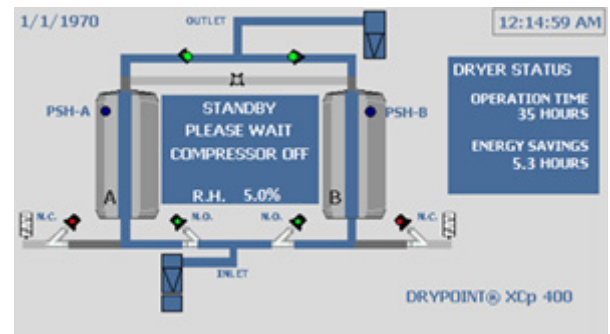

8.8 Power Requirements

The controller is able to operate using different voltages (100-120VAC/50-60Hz or 220-240VAC/50-60Hz). The units are shipped with an installed standard US 120 volt cord for convenience. Before starting up the machine it is necessary to have a qualified electrician review the electrical requirements schematic and install to the National Electric Code. Please refer to Section 12.



The optional BEKOMAT® on the pre-filter at the dryer inlet is supplied according to the power voltage indicated in the order; verify its compatibility with the information given on the type plate.

8.9 Network Connection

The controller is fitted with a PC Ethernet port which allows for a network connection. The PLC has connection features standard from Siemens that allow the PLC to be monitored for status.

An optional web server function is also available. This feature enables the following information available through a web page:

- + Operating Status and Times
- + Operating Parameters
- + Time Remaining before the next Programmed Maintenance Intervention
- + System Alarms
- + Spare Parts

To monitor the system use a standard web browser and type the following IP address: 192.168.30.130 (PLC).

For additional information on how to use the controller network capability, contact your local distributor. For technical support contact BEKO Technologies, Corp.



Only qualified personnel may carry out the service for the serial connection of the dryer. Before any service make sure that no parts of the machine are powered.

9. MAINTENANCE AND SERVICE

9.1 Routine Maintenance



The service must be carried out only by a qualified technician.



Before any service is carried out, always verify that:

- + **The power has been disconnected following proper Lock-out, Tag-out procedures**
- + **Depressurize the unit and ensure the unit is isolated from the compressed air system** (see sect. 6)



The personnel that service the machine must wear hearing and eye protection before operating the dryer. Each employee must select a proper personal protection device (PPD) hearing protector such as earmuffs, ear canal caps or earplugs in order to prevent permanent hearing damage or loss.

DAILY



- + Check that pre-filter condensate drain is working properly
- + Check the differential pressure of any installed pre and post filtration
- + Check that the tower switching operation takes place correctly at the set cycle times.
- + Check that the tower pressure gauge of the regenerating tower reads 0 psig while the drying tower reads full line pressure

ANNUALLY



- + Replace the pre and post filter elements
- + Replace the exhaust silencers
- + Replace the pre-filter float drain or BEKOMAT® service unit
- + Check if the solenoid valves are working properly
- + Check if all screws of the electrical wiring are securely tightened
- + Verify operation of the dryer

EVERY 2 YEARS



In addition to the scheduled annual maintenance:

- + Install inlet and purge exhaust valve service kit
- + Verify operation of the dryer

EVERY 2 YEARS

In addition to the scheduled annual maintenance:



- + Replace the desiccant adsorption material in both towers
- + The estimated average lifespan of the adsorption material is 3-5 years when using 10-minute cycle times or 3,000 operating hours per year. In all cases, the lifetime of desiccant material is heavily dependent on the quality and temperature of the inlet air and ensuring that scheduled maintenance is consistently carried out.
- + Verify operation of the dryer

9.2 Maintenance and Service Intervals

Preventative maintenance of the pre- and post-filter element, and desiccant material is required.

The controller monitors the dryers operating hours and will activate the maintenance alarms when certain values are reached.

	Initial Alarm	Reminder
Pre-filter	Every 4,000 hours	Every 800 hours
Post-filter		
Desiccant Material	Every 12,000 hours	Every 1,500 hours

NOTE: The maintenance alarms (reminders) do not change the operation of the controller in any way.

9.3 Fuses

Two different safety fuses are fitted on the electronic board of the controller in positions F1 and F2. The fuses protect the following circuits and are of the following type:

F1 = Mains - 2A type T, \varnothing 5x20 mm

F2 = Condensate drain solenoid valve - 1A type T, \varnothing 5x20 mm



The fuses can blow if there are any problems with the dryer. In which case, replace them, but only after solving the problem that caused the malfunction first or refer to section 9. TROUBLESHOOTING (page 29).

9.4 Desiccant Replacement



CAUTION: Activated alumina desiccant dust is considered a nuisance dust. Proper precautions should be taken prior to replacing the desiccant material in the dryer. Please refer to the Safety Data Sheet (SDS).



1. Isolate and shut down the dryer (see page 14).
2. Place a suitable container at the edge of each drain port on the bottom of the towers that are located on the sides, facing outward.
3. Open the drain ports on the bottom of the towers and catch the desiccant in the containers.
4. Refill each tower with the recommended type, size and quantity of desiccant. Only use manufacturer supplied desiccant, which is high quality, high capacity desiccant designed and sized for the dryers.
5. Carefully knock on the sides of the tower chambers while filling so that the desiccant will pack tightly. Some settling may be required in order to fit the specified fill amount into the tower. Tank sizes may be the same for multiple models, so do not be concerned if the tower is not entirely full.
6. Desiccant that has been contaminated with oil or other substances may require different disposal methods and procedures than desiccant that is being replaced due to aging. Consult the appropriate MSDS and follow all applicable laws and regulations regarding disposal.

9.5 Inlet and Exhaust Valve Repair



1. Isolate and shut down the dryer (see page 14).
2. Make certain that there are no “pockets” of pressure contained by the various valves.
3. Open the bleed valve on the bottom of the control air filter housing.
4. Loosen the “one touch” pneumatic fitting (no tools required) that attaches the control air tubing to the valve body. Carefully move the tubing aside and out of the way. We suggest
5. Disassemble the valve for cleaning or repair. Service kits are available for all valves (see page 30).
6. Reassemble the valve and ensure that all O-rings, gaskets and components have been reassembled or replaced accordingly.

10. TROUBLESHOOTING GUIDE



The troubleshooting and the eventual checks must be performed by qualified personnel only.



The technician that services the machine must wear hearing and eye protection while servicing the dryer. Each employee must select a proper personal protection device (PPD) hearing protector such as earmuffs, ear canal caps or earplugs in order to prevent permanent hearing damage or loss.

SYSTEM TROUBLE	POSSIBLE CAUSE	SUGGESTED ACTION
❖ Dryer stopped	<ul style="list-style-type: none"> ⇒ No power ⇒ Valve problem ⇒ No pilot control air ⇒ Solenoid valves ⇒ Controller ⇒ Compressor off 	<ul style="list-style-type: none"> ⇒ Check power and electric ⇒ Check the operation of inlet and purge exhaust valves ⇒ Ensure Control pilot air is delivering at 80 psi ⇒ Ensure DIN connectors are properly attached to solenoid valves ⇒ See controller troubleshooting ⇒ Check if compressor Sync is commanding dryer off
❖ All the inlet air is discharged through the silencers	<ul style="list-style-type: none"> ⇒ Faulty inlet valve ⇒ Faulty signal ⇒ Faulty Outlet valve ⇒ Pneumatic 	<ul style="list-style-type: none"> ⇒ The inlet valves are blocked – open and clean ⇒ The controller continuously supplies solenoid valve PVA and/or PVB – check the electric wiring and if necessary replace ⇒ Outlet Check valve(s) stuck open – serviceable only by qualified technician ⇒ Ensure tube routing matches diagram
❖ Liquid comes out of the silencers	<ul style="list-style-type: none"> ⇒ High dew point ⇒ Overloaded ⇒ No power ⇒ Flow control valve ⇒ No pilot control air ⇒ Exhaust Silencers 	<ul style="list-style-type: none"> ⇒ Ensure operation sequence and purge setting ⇒ Check capacity versus operating conditions ⇒ Check purge exhaust valve for normal operation ⇒ Ensure that the purge exhaust valve actuators is not closed ⇒ Ensure pilot air reading is 80 psi ⇒ Replace silencer filter elements if clogged
❖ Repressurization	<ul style="list-style-type: none"> ⇒ Purge Exhaust Valve ⇒ Purge line ⇒ Purge Valve ⇒ Inlet Valve 	<ul style="list-style-type: none"> ⇒ See purge Exhaust Valve troubleshooting ⇒ Purge setting or clog, full open purge valve to clean out and then set according to table xx ⇒ See Purge valve troubleshooting ⇒ See Inlet Valve Failure troubleshooting
❖ High Humidity or High Dewpoint	<ul style="list-style-type: none"> ⇒ Purge Valve ⇒ Exhaust Silencers ⇒ Desiccant ⇒ Purge Exhaust Valve ⇒ Low Pressure ⇒ High Flow ⇒ High Temperature ⇒ Inlet Valve ⇒ Power ⇒ Controller 	<ul style="list-style-type: none"> ⇒ ☑ Adjust and ensure correct setting based on table xx ⇒ Backpressure due to clog, install new mufflers ⇒ Media is fouled, replace new ⇒ See Purge Exhaust Valve troubleshooting ⇒ Increase to rated pressure ⇒ ensure air inlet flow does not exceed dryer capacity ⇒ ensure air inlet temperature does not exceed dryer capacity ⇒ See Inlet Valve troubleshooting ⇒ Ensure that the controller has correct voltage ⇒ See controller troubleshooting

SYSTEM TROUBLE	POSSIBLE CAUSE	SUGGESTED ACTION
❖ High Pressure Drop	<ul style="list-style-type: none"> ⇒ Desiccant ⇒ Pre-filter ⇒ Post-filter ⇒ Capacity ⇒ Desiccant screens ⇒ Purge Exhaust valve 	<ul style="list-style-type: none"> ⇒ Replace fouled desiccant ⇒ Contaminated inlet pre-filter, replace ⇒ Contaminated outlet post- filter, replace ⇒ Overflow, ensure air inlet flow does not exceed dryer capacity ⇒ Remove desiccant/screens and clean screens ⇒ See purge exhaust troubleshooting
❖ Back pressure	<ul style="list-style-type: none"> ⇒ Purge muffler fouled ⇒ Vessel screen ⇒ Restricted purge piping ⇒ Bad Purge Exhaust Valve 	<ul style="list-style-type: none"> ⇒ Replace with new ⇒ Empty towers, remove screens and clean ⇒ Clean ⇒ See purge Exhaust Valve troubleshooting
❖ Failure to Switch	<ul style="list-style-type: none"> ⇒ Purge Exhaust valve ⇒ Purge line ⇒ Purge Valve ⇒ Inlet Valve 	<ul style="list-style-type: none"> ⇒ See purge Exhaust Valve troubleshooting ⇒ Purge setting or clog, full open purge valve to clean out and then set according to table (Sec. 4) ⇒ See Purge Valve troubleshooting ⇒ See Inlet Valve Failure troubleshooting
COMPONENT TROUBLE	POSSIBLE CAUSE	SUGGESTED ACTION
❖ Sensor Failure	<ul style="list-style-type: none"> ⇒ Sensor ⇒ Electrical ⇒ Pneumatic ⇒ Controller 	<ul style="list-style-type: none"> ⇒ Check at atmosphere ⇒ Check electrical connections for short ⇒ Ensure sampling of mid-tower thru pneumatic check valves and plumbing ⇒ Faulty controller, replace after factory consultation
❖ Purge control Valve	<ul style="list-style-type: none"> ⇒ Setting ⇒ Damaged ⇒ Dirty 	<ul style="list-style-type: none"> ⇒ ensure proper setting from table xx ⇒ replace valve ⇒ open full for clean out or dismantle and clean
❖ Purge Exhaust Valve	<ul style="list-style-type: none"> ⇒ Worn seals ⇒ Pneumatic ⇒ Electrical ⇒ Restriction 	<ul style="list-style-type: none"> ⇒ Install service kit ⇒ check pilot valve, pilot air supply, pilot air filter, flow control valve on actuator ⇒ Check power to solenoid valves ⇒ Backpressure – silencers or mufflers are clogged, install new muffler elements
❖ Inlet Valve	<ul style="list-style-type: none"> ⇒ Worn seals ⇒ Pneumatic ⇒ Electrical ⇒ Restriction 	<ul style="list-style-type: none"> ⇒ Install service kit ⇒ check pilot valve, pilot air supply, pilot air filter, flow control valve on actuator ⇒ Check power to solenoid valves ⇒ Backpressure – silencers or mufflers are clogged, install new muffler elements
❖ Outlet Check Valve	<ul style="list-style-type: none"> ⇒ Restriction ⇒ Damaged Seal 	<ul style="list-style-type: none"> ⇒ SERVICEABLE ONLY BY QUALIFIED TECHNICIAN

COMPONENT TROUBLE	POSSIBLE CAUSE	SUGGESTED ACTION
❖ Drain	<ul style="list-style-type: none"> ⇒ Application ⇒ Electrical ⇒ Contaminated ⇒ Drain 	<ul style="list-style-type: none"> ⇒ Overloaded with water, check pre-filter and upstream bulk water separator ⇒ Check electrical connections ⇒ Clean drain and plumbing ⇒ Install service drain kit or replace entire unit
❖ Pre-Filter	<ul style="list-style-type: none"> ⇒ Application ⇒ Dirty element ⇒ Electrical ⇒ Differential pressure gauge 	<ul style="list-style-type: none"> ⇒ Failure with upstream bulk water separator ⇒ Contaminated filter, replace element ⇒ Faulty electrical signal ⇒ Clean, check and or replace
❖ Post-Filter	<ul style="list-style-type: none"> ⇒ Dryer dusting ⇒ Dirty element ⇒ Electrical ⇒ Differential pressure gauge 	<ul style="list-style-type: none"> ⇒ Ensure proper dryer sequence ⇒ Contaminated filter, replace element ⇒ Faulty electrical signal ⇒ Clean, check and or replace
❖ Controller	<ul style="list-style-type: none"> ⇒ Defective ⇒ No power supply ⇒ Loose connection 	<ul style="list-style-type: none"> ⇒ Replace controller ⇒ Ensure voltage supply ⇒ Check connections
❖ Relief Valve	<ul style="list-style-type: none"> ⇒ Over pressure ⇒ Leak ⇒ Over temperature 	<ul style="list-style-type: none"> ⇒ Check system pressure and correct ⇒ Replace valve ⇒ Ensure system temperature or fire has not occurred
❖ Solenoid	<ul style="list-style-type: none"> ⇒ Electrical ⇒ Pneumatic ⇒ Defective 	<ul style="list-style-type: none"> ⇒ Ensure connections and signal are adequate ⇒ Ensure pilot supply is good and valve is clean ⇒ Replace with new

11. MAINTENANCE AND SPARE PARTS

We strongly recommend stocking the suggested spare parts to help enable you to promptly carry out any required maintenance and/or replace any parts that may fail without having to wait for the parts to be delivered. If you need to replace any other parts, please contact your local distributor or BEKO Technologies, Corp. Technical Service Department at +1 (800) 235-6797 for assistance.

11.1 Required Maintenance Parts

Interval	DESCRIPTION	Order No.	080	100	120	160	200	250	300	400	500	650	800	
Annual	<i>Pre-filter Element 0.01 µm</i>													
	07SX	4038113	◆	◆	◆									
	10SX	4038149				◆								
	12SX	4038114					◆							
	15SX	4038115						◆						
	18SX	4038150							◆					
	20SX	4038151								◆	◆			
	25SX	4038116											◆	◆
	<i>Post-filter Element 1.0 µm</i>													
	07FX	4038106	◆	◆	◆									
	10FX	4038140				◆								
	12FX	4038107					◆							
	15FX	4038108						◆						
	18FX	4038141							◆					
	20FX	4038142								◆	◆			
	25FX	4038109											◆	◆
	<i>Exhaust Silencer</i>													
	¾" Exhaust Silencer	4020833	◆		2									
	1" Exhaust Silencer	4020834		◆			2							
	1¼" Exhaust Silencer	4026420							2	2				
	1½" Exhaust Silencer	4020835				◆						2		
2" Exhaust Silencer	4020836						◆					2	2	
<i>Float Drain for CLEARPOINT® (Standard)</i>														
FAD050 Float Drain	4025536	◆	◆	◆	◆	◆	◆	◆	◆	◆	◆	◆	◆	
<i>Service Unit for CLEARPOINT® with BEKOMAT® (Optional)</i>														
BEKOMAT® 31 Service Unit	4023608	◆	◆	◆	◆	◆	◆	◆	◆	◆	◆	◆	◆	
BEKOMAT® 32 Service Unit	4025061	-	-	-	-	-	-	-	-	-	-	-	-	
2 Years	<i>Inlet Angle Body Valve / Actuator Only</i>													
	¾" Inlet Valve / Actuator	4020801 / 4027892	◆											
	1" Inlet Valve / Actuator	4020803 / 4027893		◆	◆									
	1¼" Inlet Valve / Actuator	4026417 / 4027894				◆	◆							
	1½" Inlet Valve / Actuator	4020805 / 4027895						◆	◆					
	2" Inlet Valve / Actuator	4020807 / 4027896									◆	◆		
2½" Inlet Valve / Actuator	4032458 / 4027897											◆	◆	

Interval	DESCRIPTION	Order No.	080	100	120	160	200	250	300	400	500	650	800		
2 Years	<i>Exhaust Angle Body Valve / Actuator Only</i>														
	¾" Exhaust Valve / Actuator	4020800 / 4027887	◆	◆	◆										
	1" Exhaust Valve / Actuator	4020802 / 4027888				◆	◆								
	1¼" Exhaust Valve / Actuator	4026416 / 4027889						◆	◆	◆					
	1½" Exhaust Valve / Actuator	4020804 / 4027890									◆	◆			
	2" Exhaust Valve / Actuator	4020806 / 4027891												◆	
	<i>Service Seal Kit</i>														
	¾" Service Seal Kit	4027898	-	-	-	-	-	-	-	-	-	-	-	-	-
	1" Service Seal Kit	4027899	-	-	-	-	-	-	-	-	-	-	-	-	-
	1¼" Service Seal Kit	4027900	-	-	-	-	-	-	-	-	-	-	-	-	-
	1½" Service Seal Kit	4027901	-	-	-	-	-	-	-	-	-	-	-	-	-
	2" Service Seal Kit	4027902	-	-	-	-	-	-	-	-	-	-	-	-	-
	2½" Service Seal Kit	4027903	-	-	-	-	-	-	-	-	-	-	-	-	-
3 Years	<i>Desiccant Adsorption Material</i>														
	¾" Activated Alumina (total weight in lbs. per dryer)	4027023	132	167	167	262	262	384	384	539	715	917	1114		

11.2 Spare Parts

DESCRIPTION	Order No.	080	100	120	160	200	250	300	400	500	650	800
<i>Inline Check Valve (Outlet)</i>												
¾" Outlet Poppet Check Valve	4020820	◆										
1" Outlet Poppet Check Valve	4020822		◆	◆								
1¼" Outlet Poppet Check Valve	4026421				◆	◆						
1½" Outlet Poppet Check Valve	4020821						◆	◆				
2" Outlet Poppet Check Valve	4020823								◆	◆		
2½" Outlet Poppet Check Valve	4020816										◆	◆
<i>Pressure Relief Safety Valve</i>												
¼" Pressure Relief Safety Valve	4026666	◆	◆	◆								
½" Pressure Relief Safety Valve	4026667				◆	◆						
¾" Pressure Relief Safety Valve	4026668						◆	◆	◆	◆		
1" Pressure Relief Safety Valve	4026669										◆	◆
<i>Purge Flow Control Valve</i>												
½" Purge Flow Control Valve	4020764	◆	◆	◆	◆							
¾" Purge Flow Control Valve	4020765					◆	◆	◆				
1" Purge Flow Control Valve	4020766								◆	◆	◆	◆
<i>Electronic Controller</i>												
BEKOTOUCH Controller / PLC	4052559	◆	◆	◆	◆	◆	◆	◆	◆	◆	◆	◆
BEKOTOUCH Display Screen	4052560	◆	◆	◆	◆	◆	◆	◆	◆	◆	◆	◆
<i>Solenoid Valve</i>												
*Complete Solenoid Valve Assembly (INDOOR models ONLY)	4054522	◆	◆	◆	◆	◆	◆	◆	◆	◆	◆	◆
Individual Solenoid Valves (OUTDOOR models ONLY), 4/dryer	4049432	◆	◆	◆	◆	◆	◆	◆	◆	◆	◆	◆
<i>Tower Pressure Gauge</i>												
2½" 0-160 psig Pressure Gauge	4026664	◆	◆	◆	◆	◆	◆	◆	◆	◆	◆	◆
Gauge Clamp	4026665	◆	◆	◆	◆	◆	◆	◆	◆	◆	◆	◆
<i>FRL Combo Package</i>												
¼" 20-130 psig Filter Regulator Combo	4026419	◆	◆	◆	◆	◆	◆	◆	◆	◆	◆	◆
<i>Pilot Air Filter Element</i>												
Replacement Filter Element for FRL Combo	4038241	◆	◆	◆	◆	◆	◆	◆	◆	◆	◆	◆
<i>Brass Cone Silencer</i>												
Replacement Brass Cone Silencer	4026418	◆	◆	◆	◆	◆	◆	◆	◆	◆	◆	◆
<i>On / Off Switch</i>												
Replacement On / Off Switch	4026722	◆	◆	◆	◆	◆	◆	◆	◆	◆	◆	◆
<i>Pressure Switch</i>												
Replacement Pressure Switch	on request	◆	◆	◆	◆	◆	◆	◆	◆	◆	◆	◆
<i>Tube Fitting Package</i>												
Replacement Tube Fitting Package	on request	◆	◆	◆	◆	◆	◆	◆	◆	◆	◆	◆
<i>Speed Control</i>												
Replacement Speed Control	4027427	◆	◆	◆	◆	◆	◆	◆	◆	◆	◆	◆
<i>Screen for EMS</i>												
Replacement screen for EMS	on request	◆	◆	◆	◆	◆	◆	◆	◆	◆	◆	◆
<i>Tower Screen</i>												
Replacement Tower Screen	on request	◆	◆	◆	◆	◆	◆	◆	◆	◆	◆	◆

NOTE: *For Serial Numbers up to and including 15328807, use Order No. 4024046.

When inquiring about any other part always indicate the data listed on the identification plate.

12. DISMANTLING OF THE DRYER

If the dryer is to be dismantled and disposed of then it must be split into groups of materials of construction.

Part	Material
Desiccant material	Activated alumina, Oil contaminated
Frame and supports	Carbon steel, Powder coated
Piping	Galvanized steel, Galvanized malleable iron, Brass, Aluminum
Towers and screens	Carbon steel, Stainless steel
Valves	Brass, Stainless steel, Bronze, Plastic
Filter housing	Aluminum, Epoxy paint
Filter cartridge	Filtering material, PVC, Oil
Solenoid valve	Bronze, Steel, Techno-polymer, PVC
Condensate Drain	PVC, Aluminum, Steel, Bronze
Silencers	Aluminum, Stainless steel
Safety Valves	Brass, Bronze
Gaskets and O-Ring	Graphite, Synthetic elastomer
Electric cables	Copper, PVC
Electric Parts	PVC, Copper, Bronze, Silicon



We recommend complying with the safety rules and regulations for the disposal of each type of material. The adsorption material and the filter cartridge will contain droplets of lubrication oil. Do not dispose of these materials in the environment. All local Governmental laws and regulations must be followed in disposing of the above listed materials.

13. GENERAL DESCRIPTION OF PARTS

- + **Desiccant** – An adsorbent used for drying air or gases. The proper quantity, size and type are necessary.
- + **Inlet Valve** – Normally open air operated switching valves used to direct air flow through the towers.
- + **Exhaust Valve** – Normally closed air operated switching valves used to exhaust purge air, hold air in the on-line tower and exhaust air from the tower ready to be regenerated.
- + **Outlet and Check Valves** – Valves that allow full flow in one direction and no flow in the opposite direction. These valves are used in conjunction with the inlet and exhaust valves to control the desired flow of process air through the dryer.
- + **Safety Relief Valves** – Valves on each tower to protect the vessels from overpressure situations. The setting is indicated on each valve.
- + **Purge Exhaust Silencer** – Installed to reduce exhaust noise during purge and blow down for the protection all personnel and to comply with OSHA standards. Silencers are non-mechanical, but must be maintained.
- + **Purge Flow Control Valve** – Valve that allows the adjustment and regulation of purge air flow used for the regeneration process.
- + **BEKOTOUCH Controller** – Electronic controller that provides an interface between the operator and dryer, provides dryer cycle control, operates the electric solenoid valves, provides indicator lights and alarm controls. All hard wired connections, including the power connections during installation are made to this device.
- + **Electric Solenoid** – An electromechanical device used for controlling the flow of liquid or gas.

For technical product support please call +1 (800) 235-6797 and select Option 2

The product categories

 **Condensate drainage**
BEKOMAT®

 **Filtration**
CLEARPOINT®

 **Measurement technology**
METPOINT®

 **Condensate processing**
ÖWAMAT® | QWIK-PURE® | BEKOSPLIT®

 **Drying**
DRYPOINT®

 **Process technology**
BEKOKAT®



BEKO TECHNOLOGIES CORP.
900 Great Southwest Pkwy SW
Atlanta, GA 30336
USA

Phone +1 (404) 924-6900
Fax +1 (404) 629-6666

beko@bekousa.com
www.bekousa.com



Subject to technical changes without prior notice; the information provided does not represent characteristics of state within the meaning of the German Civil Code (BGB).
® Registered Trademarks by BEKO TECHNOLOGIES GmbH, Neuss, Germany and BEKO TECHNOLOGIES CORP, Atlanta, GA USA.

REVISION TABLE				
REV	CHANGE NO.	DESCRIPTION	DATE	APPROVAL
A.00	-	-	10/25/18	JAS
A.01	-	Increased scale of diagram, decreased scale of item list, updated title block location	01/04/21	JSC

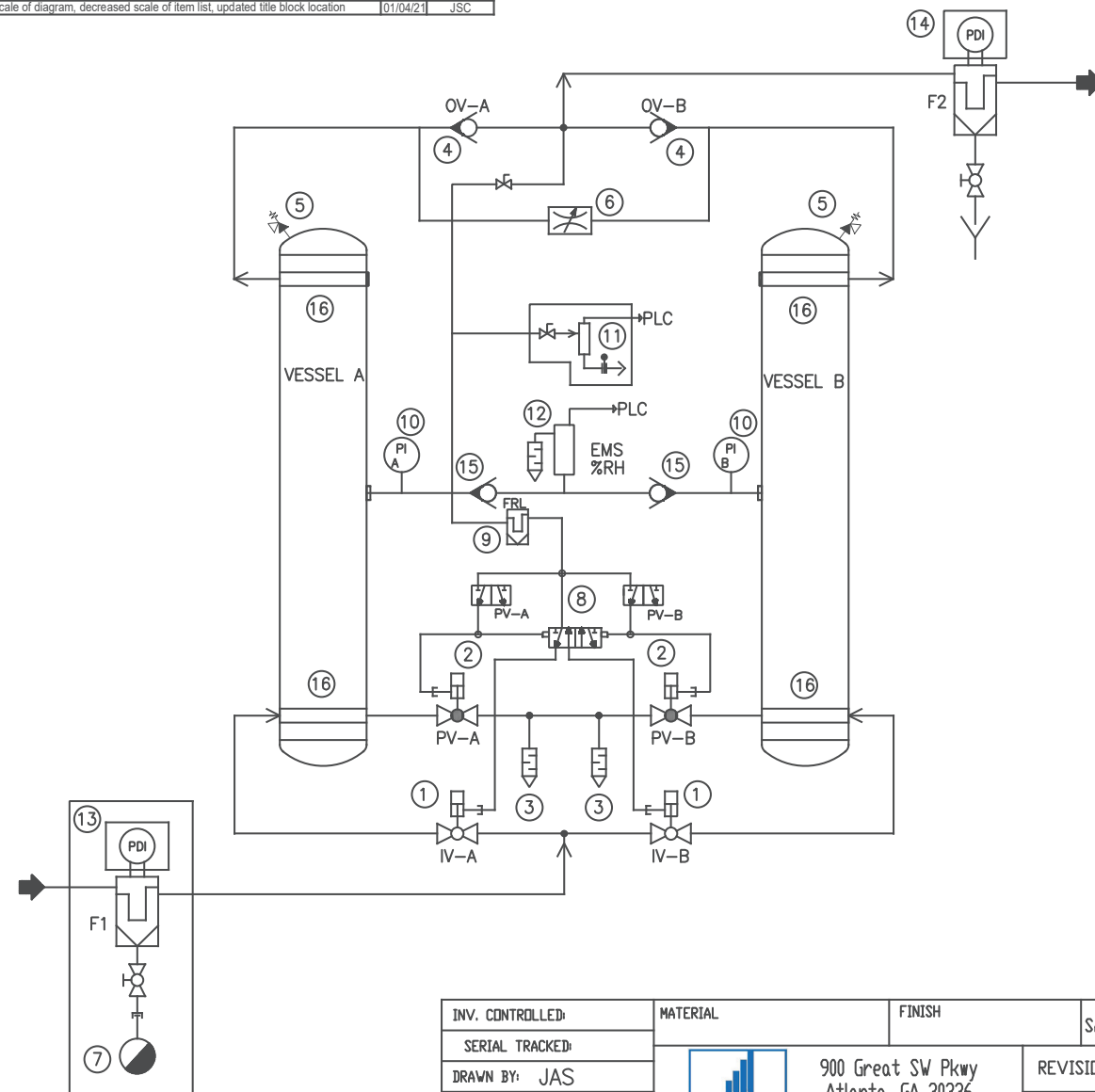

P&ID Item List	
1	Inlet Valve (N.O.)
2	Exhaust Valve (N.C.)
3	Exhaust Silencer
4	Outlet Check Valve
5	Pressure Relief Valve
6	Purge Control Valve
7	BEKOMAT Zero Loss Drain
8	Solenoid Valve Assembly
9	Pilot Air Filter/Regulator
10	Vessel Pressure Gauge
11	Dew Point Sensor (Optional)
12	Energy Management System % Rel. Humidity Sensor
13	Pre-filter (Required)
14	Post-filter (Recommended)
15	Tube Check Valve
16	Desiccant Screen

INV. CONTROLLED:	MATERIAL	FINISH	SAP: N/A	CAT: 08C	ID# 0000202
SERIAL TRACKED:	 900 Great SW Pkwy Atlanta, GA 30336 Ph: (800) 235-6797 Fax: (404) 629-6666 www.bekousa.com		REVISION: A.01	TITLE: DPXCp Threaded P&ID	
DRAWN BY: JAS			UNLESS OTHERWISE SPECIFIED: <small>DIMENSIONS ARE IN INCHES TOLERANCES: LINEAR: 1/4 ANGULAR: ±2 ○ DENOTES INSPECTION DIM</small>	DESCRIPTION: P&ID for XCP 80 through 800 Standard Indoor	
PROPRIETARY AND CONFIDENTIAL <small>THE INFORMATION CONTAINED IN THIS DRAWING IS THE SOLE PROPERTY OF BEKO TECHNOLOGIES CORP. ANY REPRODUCTION IN PART OR AS A WHOLE WITHOUT THE WRITTEN PERMISSION OF THE AFOREMENTIONED IS PROHIBITED.</small>	<small>DO NOT SCALE DRAWING</small>		SIZE: B	SCALE:	SHEET 1 OF 1

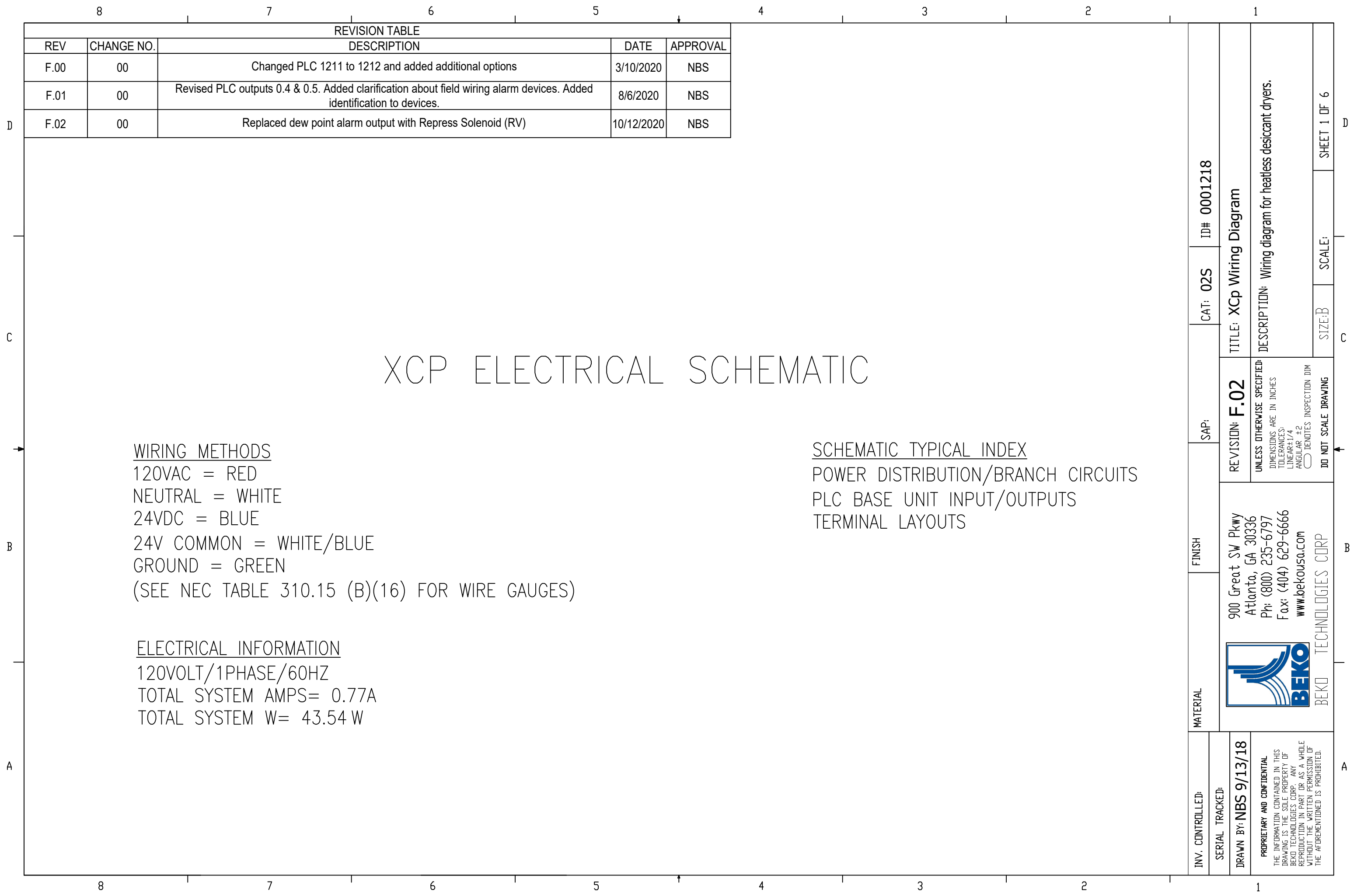

XCP ELECTRICAL SCHEMATIC

WIRING METHODS

120VAC = RED
 NEUTRAL = WHITE
 24VDC = BLUE
 24V COMMON = WHITE/BLUE
 GROUND = GREEN
 (SEE NEC TABLE 310.15 (B)(16) FOR WIRE GAUGES)

ELECTRICAL INFORMATION

120VOLT/1PHASE/60HZ
 TOTAL SYSTEM AMPS= 0.77A
 TOTAL SYSTEM W= 43.54 W

SCHEMATIC TYPICAL INDEX

POWER DISTRIBUTION/BRANCH CIRCUITS
 PLC BASE UNIT INPUT/OUTPUTS
 TERMINAL LAYOUTS

REVISION TABLE				
REV	CHANGE NO.	DESCRIPTION	DATE	APPROVAL
F.00	00	Changed PLC 1211 to 1212 and added additional options	3/10/2020	NBS
F.01	00	Revised PLC outputs 0.4 & 0.5. Added clarification about field wiring alarm devices. Added identification to devices.	8/6/2020	NBS
F.02	00	Replaced dew point alarm output with Repress Solenoid (RV)	10/12/2020	NBS

INV. CONTROLLED:	FINISH	SAP:	CAT: 02S	ID# 0001218
SERIAL TRACKED:	REVISION: F.02 <small>UNLESS OTHERWISE SPECIFIED: DIMENSIONS ARE IN INCHES TOLERANCES: LINEAR: ±1/4 ANGULAR: ±2 Ø DENOTES INSPECTION DIM</small>			
DRAWN BY: NBS 9/13/18	900 Great SW Pkwy Atlanta, GA 30336 Ph: (800) 235-6797 Fax: (404) 629-6666 www.bekouso.com			
PROPRIETARY AND CONFIDENTIAL <small>THE INFORMATION CONTAINED IN THIS DRAWING IS THE SOLE PROPERTY OF BEKO TECHNOLOGIES CORP. ANY REPRODUCTION IN PART OR AS A WHOLE WITHOUT THE WRITTEN PERMISSION OF THE AFOREMENTIONED IS PROHIBITED.</small>	 BEKO TECHNOLOGIES CORP			
		DO NOT SCALE DRAWING	SIZE: B	SCALE:
				SHEET 1 OF 6

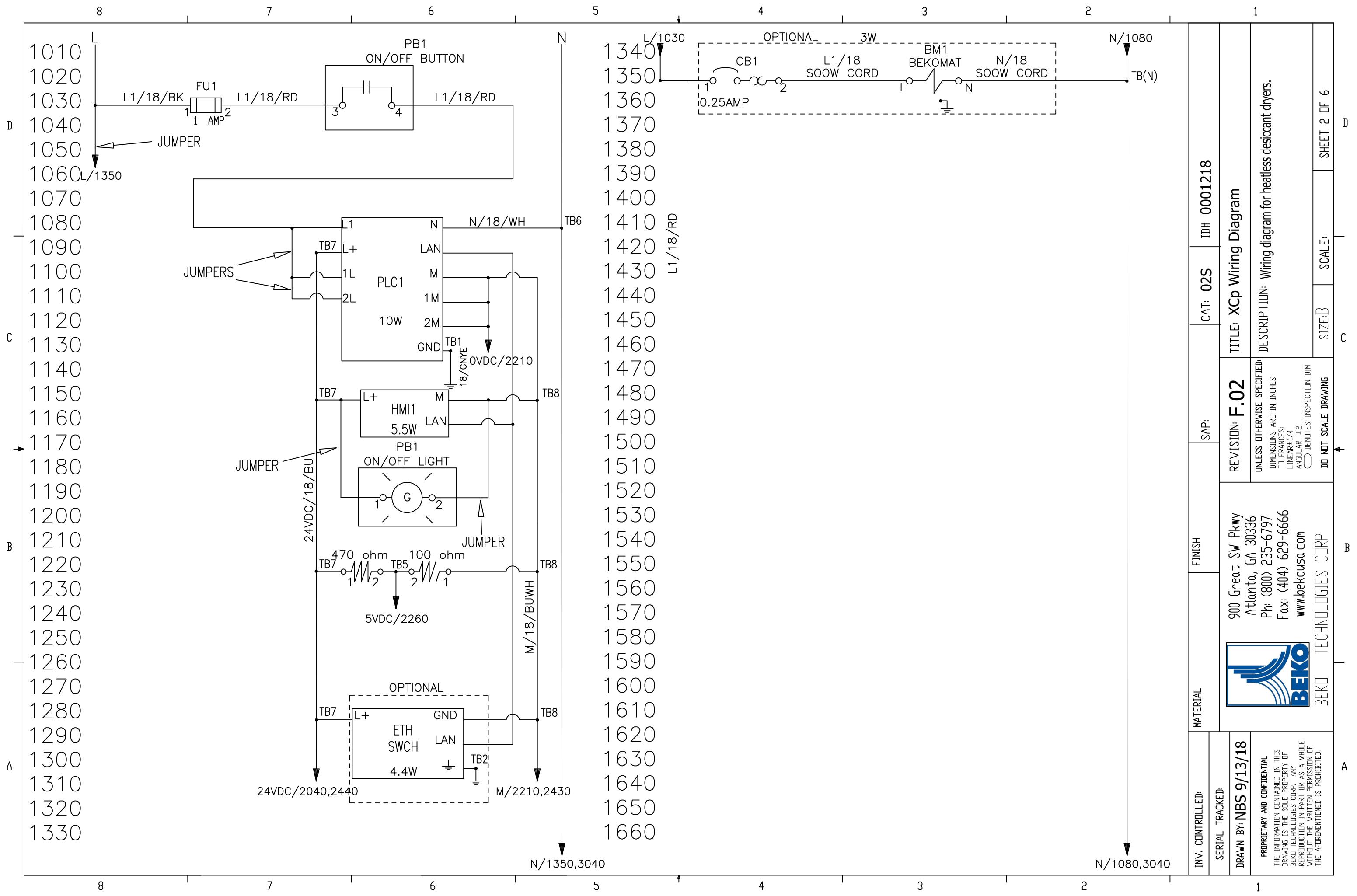

1010
1020
1030
1040
1050
1060
1070
1080
1090
1100
1110
1120
1130
1140
1150
1160
1170
1180
1190
1200
1210
1220
1230
1240
1250
1260
1270
1280
1290
1300
1310
1320
1330

1340
1350
1360
1370
1380
1390
1400
1410
1420
1430
1440
1450
1460
1470
1480
1490
1500
1510
1520
1530
1540
1550
1560
1570
1580
1590
1600
1610
1620
1630
1640
1650
1660

INV. CONTROLLED:	SERIAL TRACKED:	DRAWN BY: NBS 9/13/18		900 Great SW Pkwy Atlanta, GA 30336 Ph: (800) 235-6797 Fax: (404) 629-6666 www.bekousa.com	FINISH	MATERIAL	SAP:	CAT: 02S	ID# 0001218
					TITLE: XcP Wiring Diagram	DESCRIPTION: Wiring diagram for heatless desiccant dryers.	REVISION: F.02	UNLESS OTHERWISE SPECIFIED: DIMENSIONS ARE IN INCHES TOLERANCES: LINEAR: ±0.004 ANGULAR: ±2 Ø DENOTES INSPECTION DIM	DO NOT SCALE DRAWING

PROPRIETARY AND CONFIDENTIAL
 THE INFORMATION CONTAINED IN THIS
 DRAWING IS THE SOLE PROPERTY OF
 BEKO TECHNOLOGIES CORP. ANY
 REPRODUCTION IN PART OR AS A WHOLE
 WITHOUT THE WRITTEN PERMISSION OF
 THE AFOREMENTIONED IS PROHIBITED.

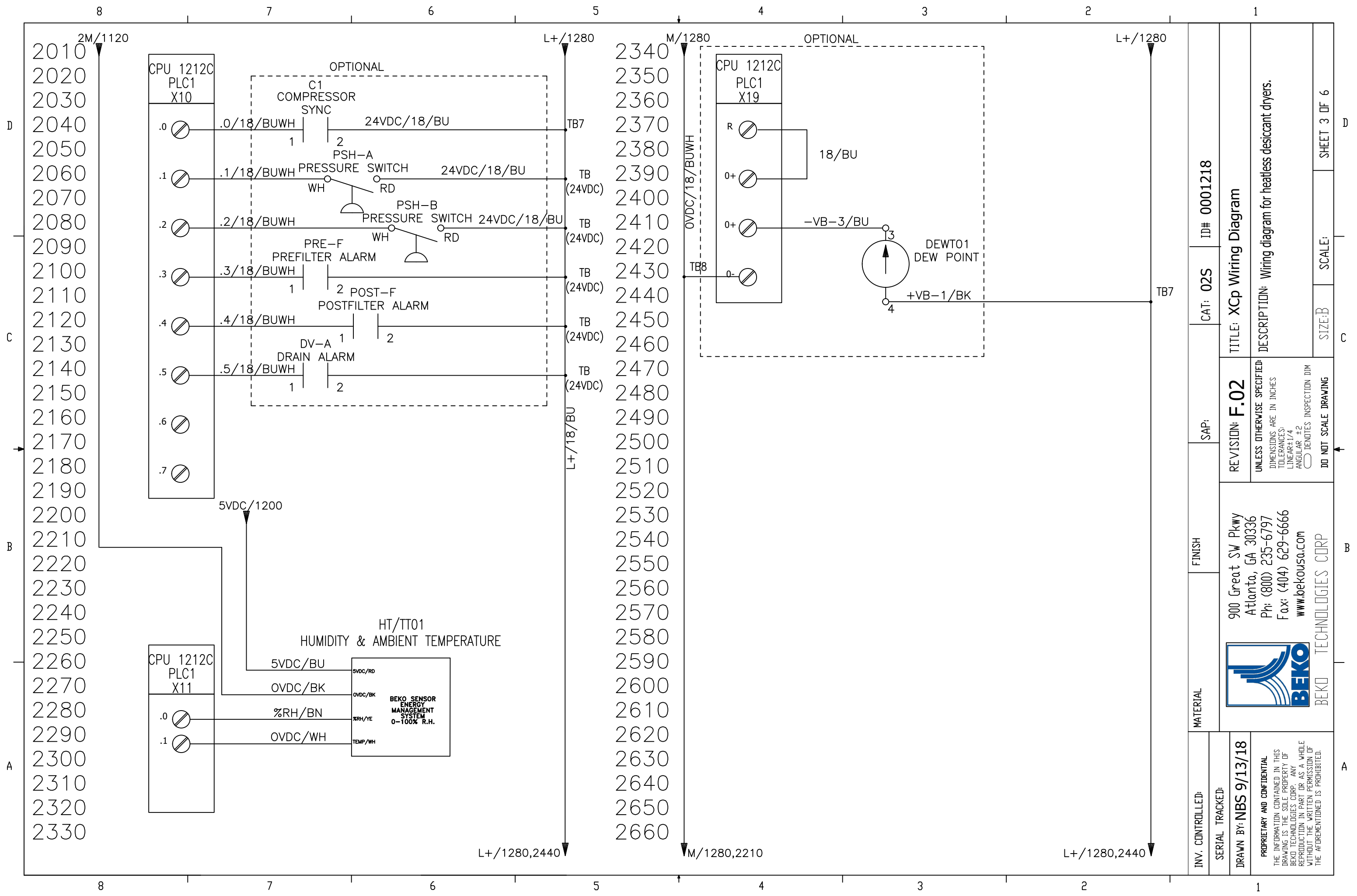

INV. CONTROLLED:	CAT: 02S	ID# 0001218
SERIAL TRACKED:	SAP:	
DRAWN BY: NBS 9/13/18	TITLE: XcP Wiring Diagram	
PROPRIETARY AND CONFIDENTIAL THE INFORMATION CONTAINED IN THIS DRAWING IS THE SOLE PROPERTY OF BEKO TECHNOLOGIES CORP. ANY REPRODUCTION IN PART OR AS A WHOLE WITHOUT THE WRITTEN PERMISSION OF THE AFOREMENTIONED IS PROHIBITED.	DESCRIPTION: Wiring diagram for heatless desiccant dryers.	
	SIZE: B	SCALE:
		SHEET 3 OF 6

FINISH

900 Great SW Pkwy
Atlanta, GA 30336
Ph: (800) 235-6797
Fax: (404) 629-6666
www.bekousa.com

BEKO TECHNOLOGIES CORP

MATERIAL

D

C

B

A

D

C

B

A

8

7

6

5

4

3

2

1

8

7

6

5

4

3

2

1

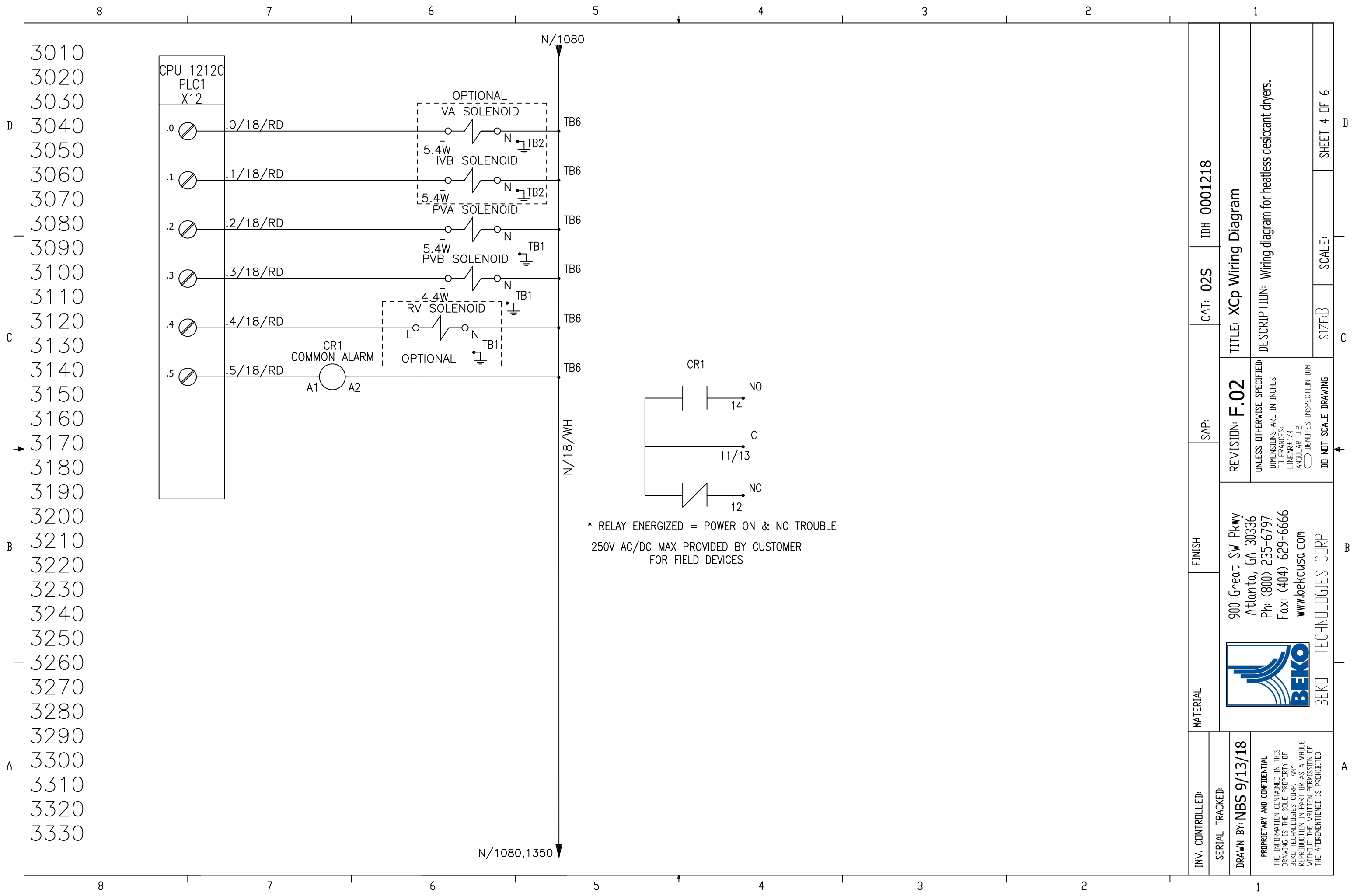

INV. CONTROLLED:	FINISH	SAP:	CAT: 02S	ID# 0001218
SERIAL TRACKED:	REVISION: F.02			
DRAWN BY: NBS 9/13/18	TITLE: XCp Wiring Diagram			
PROPRIETARY AND CONFIDENTIAL THE INFORMATION CONTAINED IN THIS DRAWING IS THE SOLE PROPERTY OF BEKO TECHNOLOGIES CORP. ANY REPRODUCTION IN PART OR AS A WHOLE WITHOUT THE WRITTEN PERMISSION OF THE AFOREMENTIONED IS PROHIBITED.	900 Great SW Pkwy Atlanta, GA 30336 Ph: (800) 235-6797 Fax: (404) 629-6666 www.bekousa.com			DESCRIPTION: Wiring diagram for heatless desiccant dryers.
	MATERIAL 	DO NOT SCALE DRAWING DIMENSIONS ARE IN INCHES TOLERANCES: LINEAR: ±.014 ANGULAR: ±2° DIMENSIONS INSPECTION DIM	SIZE: B	SCALE:

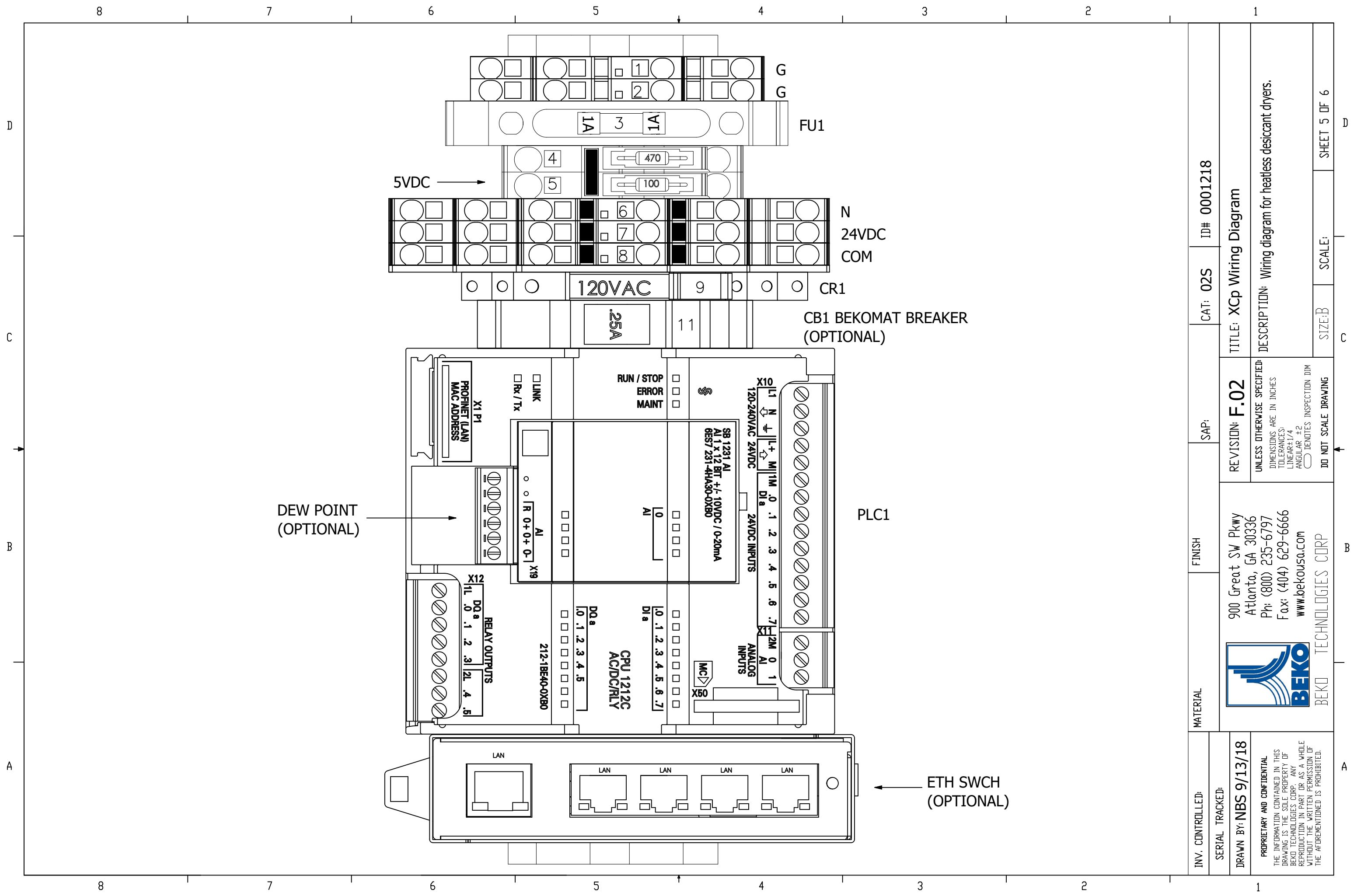

INV. CONTROLLED:	MATERIAL	FINISH	SAP:	CAT: 02S	ID# 0001218
SERIAL TRACKED:	900 Great SW Pkwy Atlanta, GA 30336 Ph: (800) 235-6797 Fax: (404) 629-6666 www.bekousa.com				
DRAWN BY: NBS 9/13/18					
<p>PROPRIETARY AND CONFIDENTIAL</p> <p>THE INFORMATION CONTAINED IN THIS DRAWING IS THE SOLE PROPERTY OF BEKO TECHNOLOGIES CORP. ANY REPRODUCTION IN PART OR AS A WHOLE WITHOUT THE WRITTEN PERMISSION OF THE AFOREMENTIONED IS PROHIBITED.</p>	<p>REVISION: F.02</p> <p>UNLESS OTHERWISE SPECIFIED: DIMENSIONS ARE IN INCHES TOLERANCES: LINEAR: ±.004 ANGULAR: ±.2 Ø DENOTES INSPECTION DIM</p> <p>DO NOT SCALE DRAWING</p>				
TITLE: XcP Wiring Diagram			DESCRIPTION: Wiring diagram for heatless desiccant dryers.		
SCALE: A			SCALE: B		
SHEET 5 OF 6			SHEET 5 OF 6		

TERMINAL BLOCK DIAGRAM

BOTTOM	COLOR		MIDDLE	COLOR		TOP	COLOR		TERMINALS		COLOR	TOP		COLOR	MIDDLE		COLOR	BOTTOM			
Supply - Gnd	GN	○				PVA-G	GN	○	TB1 (Ground)	□	○	GN	PVB-G		□	○	GN/YE	PLC X10 - E			
EthSwch - E	GN/YE	○				RV-G	GN	○	TB2 (Ground)	□	○	GN	IVB-G		□	○	GN	IVA-G			
Supply - L	BK	○	1 Amp Fast Acting Fuse						TB3								○	RD	PB1-3		
TB9-Bottom	BK		470 OHM RESISTOR BLOCK						TB4								○	BU	TB7-Middle		
	BU		100 OHM RESISTOR BLOCK						TB5								○	BU/WH	TB8-Middle		
HT/TT01-5V	BU/WH								TB6 (N)		○	WH	IVA-N		○	WH	IVB-N	WH	X10 - N		
Supply - N	WH	○	PVA-N	WH	○	PVB-N	WH	○	TB7 (24VDC)		○	BU	C1-2		○	BN	+VB-1	BU	PLC X10-L+		
HMI X80-L+	BU	○	TB470ohm-BOT	BU	○	EthSwch - L+	BU	○	TB8 (COM)		○	BU/WH	PLC X19- 0-	□	○	BU/WH	PLC X10-M	BU/WH	PLC X10-M		
HMI X80-M	BU/WH	○	TB100ohm-BOT	BU/WH	○	EthSwch - GND	BU/WH	○	COMMON ALARM SOLID STATE MODULE						○	WH	(N) TB	○	RD	PLC X12-.5	
FIELD WIRE-12		○	FIELD WIRE-14		○	FIELD WIRE-11/13		○	0.25 Amp Thermal Fuse (OPTIONAL)						○				○	BK	BM1-L
TB3-Bottom	BK	○																			
PLC1																					
TB7-Top	BU	○	ETHERNET SWITCH (OPTIONAL)																		
TB8-Top	BU/WH	○																			
TB2-Bottom	GN/YE	○																			

- Horizontal Jumper
- Vertical Jumper
- Optional

INV. CONTROLLED: ID# 0001218

SAP: CAT: 025

FINISH

MATERIAL

TITLE: XcP Wiring Diagram

REVISION: F.02

900 Great SW Pkwy
Atlanta, GA 30336
Ph: (800) 235-6797
Fax: (404) 629-6666
www.bekouso.com



DRAWN BY: NBS 9/13/18

PROPRIETARY AND CONFIDENTIAL
THE INFORMATION CONTAINED IN THIS DRAWING IS THE SOLE PROPERTY OF BEKO TECHNOLOGIES CORP. ANY REPRODUCTION IN PART OR AS A WHOLE WITHOUT THE WRITTEN PERMISSION OF THE AFOREMENTIONED IS PROHIBITED.

DESCRIPTION: Wiring diagram for heatless desiccant dryers.

SCALE: SHEET 6 OF 6

SIZE: B

DO NOT SCALE DRAWING

BEKO TECHNOLOGIES CORP

A

D

C

B

A

D

C

B

A

D

C

B

A