

EN - english



Instructions for installation and operation

Compressed air refrigeration dryer

DRYPOINT® RAX 200-500 NA 3PH UL

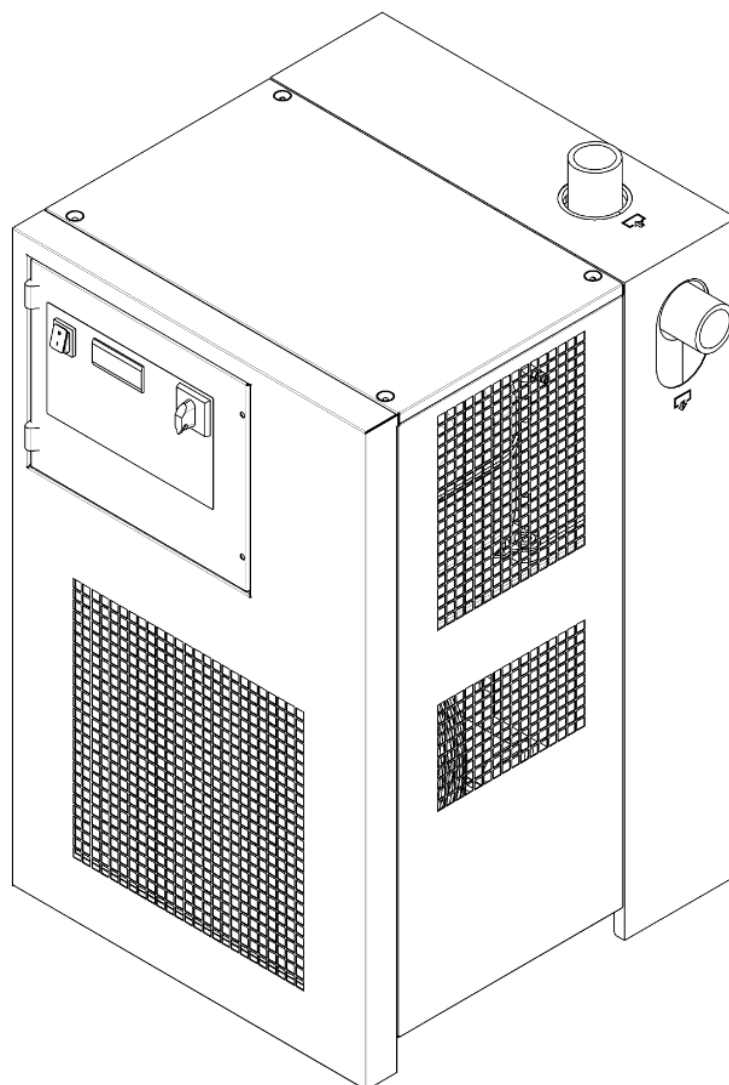

Dear customer,

Thank you for deciding in favour of the DRYPOINT® RAX 200-500 NA compressed-air refrigeration dryer. Please read these installation and operating instructions carefully before mounting and starting up the DRYPOINT® RAX 200-500 NA and follow our directions. Perfect functioning of the DRYPOINT® RAX 200-500 NA and thus reliable compressed-air drying can only be guaranteed when the provisions and notes stipulated here are strictly adhered to.

Contents

1	Name plate	5
2	Safety instructions	5
2.1	Safety pictograms in accordance with DIN 4844	6
2.2	Signal words in accordance with ANSI	8
2.3	Overview of the safety instructions	8
3	Proper use	10
4	Exclusion from a field of application	11
5	Operating instructions in accordance with the 2014/68/EU Pressure Equipment Directive	11
6	Transport	11
7	Storage	12
8	Installation	12
8.1	Place of installation	12
8.2	Installation plan	13
8.3	Correction factors	14
8.4	Connection to the compressed-air system	15
8.5	Connection to the cooling-water network	15
8.6	Minimum cooling water requirements:	16
8.7	Electrical connections	16
8.8	Condensate drain	17
9	Start-up	17
9.1	Preliminary stages	17
9.2	Initial start-up	18
9.3	Shut down and restart	19
10	Technical data	20
10.1	Technical data DRYPOINT RAX 200-500 NA 3phase 3/460/60	20
10.2	Technical data DRYPOINT RAX 200-500 NA 3phase 3/575/60	21
11	Technical description	22
11.1	Control panel	22
11.2	Functional description	22
11.3	Flow chart (air-cooled)	23
11.4	Flow chart (water-cooled)	23
11.5	Refrigerating compressor	24
11.6	Condenser (air-cooled)	24
11.7	Condenser (water-cooled)	24
11.8	Cooling-water regulating valve	24
11.9	Filter dryer	24
11.10	Capillary tube	24
11.11	Aluminium heat exchanger	24
11.12	Hot-gas bypass valve	25
11.13	Refrigerant pressure switches LPS – HPS – PV	25
11.14	Safety temperature switch TS	25
11.15	Compressor crankcase heater	25
11.16	DMC18 electronic control unit	26
11.16.1	Switching the dryer on	26
11.16.2	Switching the dryer off	26
11.16.3	Indication of the operating parameters	26
11.16.4	Indication of a service warning/service alarm	26
11.16.5	Operation of the potential-free failure/alarm contact	27
11.16.6	How to change operating parameters – SETUP menu	27
11.16.7	Selection of the BEKOMAT drain model	28
11.17	Electronically level-controlled BEKOMAT condensate drain	28
12	Maintenance, troubleshooting, spare parts and dismantling	28
12.1	Checks and maintenance	28
12.2	Troubleshooting	30
12.3	Recommended spare parts	33
12.4	Maintenance works at the refrigeration cycle	34
12.5	Dismantling the dryer	34

13	Appendices	35
13.1	Dryer dimensions	35
13.1.1	Dryer dimensions DRYPOINT RAX 200-250 NA 3phase	35
13.1.2	Dryer dimensions DRYPOINT RAX 300-350 NA 3phase	36
13.1.3	Dryer dimensions DRYPOINT RAX 400-500 NA 3phase	37
13.2	Exploded diagrams	38
13.2.1	Components of the exploded diagrams	38
13.2.2	Exploded diagram DRYPOINT RAX 200-250 NA 3phase / AC	39
13.2.3	Exploded diagram DRYPOINT RAX 300-350 NA 3phase / AC	40
13.2.4	Exploded diagram DRYPOINT RAX 400-500 NA 3phase / AC	41
13.2.5	Exploded diagram DRYPOINT RAX 200-250 NA 3phase / WC	42
13.2.6	Exploded diagram DRYPOINT RAX 300-350 NA 3phase / WC	43
13.2.7	Exploded diagram DRYPOINT RAX 400-500 NA 3phase / WC	44
13.3	Electric diagrams	45
13.3.1	Electric diagrams – list of components	45
13.3.2	Electric diagram DRYPOINT RAX 200-350 NA 3phase Sheet 1/3	46
13.3.3	Electric diagram DRYPOINT RAX 200-350 NA 3phase Sheet 2/3	47
13.3.4	Electric diagram DRYPOINT RAX 200-350 NA 3phase Sheet 3/3	48
13.3.5	Electric diagram DRYPOINT RAX 400-500 NA 3phase Sheet 1/3	49
13.3.6	Electric diagram DRYPOINT RAX 400-500 NA 3phase Sheet 2/3	50
13.3.7	Electric diagram DRYPOINT RAX 400-500 NA 3phase Sheet 3/3	51

1 Name plate

The name plate is on the back of the dryer and comprises all primary data of the device. Always refer to these when contacting the manufacturer or the sales department.

All guarantee claims will expire in the event that the name plate is modified or removed.

2 Safety instructions



Please check whether or not these instructions correspond to the device type.

Please adhere to all advice given in these operating instructions. They include essential information which must be observed during installation, operation and maintenance. Therefore, it must be ensured that these operating instructions are read by the fitter and the responsible operator / certified skilled personnel prior to installation, start-up and maintenance.

The operating instructions must be accessible at all times at the place of application of the DRYPOINT® RAX 200-500 NA compressed-air refrigeration dryer.

In addition to these operating instructions, local and national regulations need to be observed, where required .

Ensure that operation of the DRYPOINT® RAX 200-500 NA compressed-air refrigeration dryer only takes place within the permissible limit values indicated on the name plate. Any deviation from these limit values involves a risk for persons and for the material, and may result in malfunction or a breakdown.

After installing the device correctly and in accordance with the instructions in this manual, the dryer is ready to operate, further settings are not required. Operation is fully automatic and maintenance is limited to several examinations and cleaning measures which are described in the following chapters.

This manual must be available at all times for future reference and is a constituent part of the dryer.

If you have any queries regarding these installation and operating instructions, please contact BEKO TECHNOLOGIES

2.1 Safety pictograms in accordance with DIN 4844



Observe operating instructions



General danger symbol



Supply voltage



Danger: component or system under pressure



Hot surfaces



Non-breathable air



Do not use water to extinguish the fire



Do not operate with open cover (housing)



Maintenance works or controlling measures must only be carried out by qualified personnel¹



Do not smoke



Note



Connection point compressed-air inlet



Connection point compressed-air outlet



Connection point condensate drain



Connection point cooling-water inlet (water-cooled)

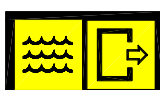

Connection point cooling-water outlet (water-cooled)

¹ Certified skilled personnel are persons who are authorised by the manufacturer, with experience and technical training, who are well-grounded in the respective provisions and laws and capable of carrying out the required works and of identifying and avoiding any risks during the machine transport, installation, operation and maintenance. Qualified and authorised operators are persons who are instructed by the manufacturer regarding the handling of the refrigeration system, with experience and technical training, and who are well-grounded in the respective provisions and laws.



Works can be carried out by the operator of the plant, provided that they are skilled accordingly².

NOTE: Text that contains important specifications to be considered – does not refer to safety precautions.



The device was carefully designed with particular attention paid to environmental protection:

- CFC-free refrigerants
- CFC-free insulation material
- Energy-saving design
- Limited acoustic emissions
- Dryer and packaging comprise reusable materials

This symbol advises the user to observe the environmental aspects and comply with the recommendations connected with this symbol.

² Certified skilled personnel are persons who are authorised by the manufacturer, with experience and technical training, who are well-grounded in the respective provisions and laws and capable of carrying out the required works and of identifying and avoiding any risks during the machine transport, installation, operation and maintenance. Qualified and authorised operators are persons who are instructed by the manufacturer regarding the handling of the refrigeration system, with experience and technical training, and who are well-grounded in the respective provisions and laws.

2.2 Signal words in accordance with ANSI

Danger!	Imminent hazard Consequences of non-observance: serious injury or death
Warning!	Potential hazard Consequences of non-observance: possible serious injury or death
Caution!	Imminent hazard Consequences of non-observance: possible injury or property damage
Notice!	Potential hazard Consequences of non-observance: possible injury or property damage
Important!	Additional advice, info, hints Consequences of non-observance: disadvantages during operation and maintenance, no danger

2.3 Overview of the safety instructions



Certified skilled personnel

Installation works must exclusively be carried out by authorised and qualified skilled personnel. Prior to undertaking any measures on the DRYPOINT® RAX 200-500 NA compressed-air refrigeration dryer, the certified skilled personnel shall read up on the device by carefully studying the operating instructions. The operator is responsible for the adherence to these provisions. The respective directives in force apply to the qualification and expertise of the certified skilled personnel.

For safe operation, the device must only be installed and operated in accordance with the indications in the operating instructions. In addition, the national and operational statutory provisions and safety regulations, as well as the accident prevention regulations required for the respective case of application, need to be observed during employment. This applies accordingly when accessories are used.



Danger!

Compressed air!

Risk of serious injury or death through contact with quickly or suddenly escaping compressed air or through bursting and/or unsecured plant components.

Compressed air is a highly dangerous energy source.

Never work on the dryer when the system is under pressure.

Never direct the compressed-air outlet or condensate drain hoses at persons.

The user is responsible for the proper installation of the dryer. Non-observance of the instructions in the "Installation" chapter leads to the expiration of the guarantee. Improper installation may result in dangerous situations for the personnel and/or the device.



Danger!

Supply voltage!

Contact with non-insulated parts carrying supply voltage involves the risk of an electric shock resulting in injuries and death.

Only qualified and skilled personnel are authorised to run electrically-operated devices. Prior to undertaking maintenance measures at the device, the following requirements must be met:

Make sure that the power supply is switched off and that the device is off and marked for maintenance measures. Please also ensure that the power supply cannot be re-established during the works.



Caution!

Refrigerant!

The compressed-air refrigeration dryer uses HFC-containing refrigerants as a coolant.

Please observe the corresponding paragraph entitled "Maintenance works at the refrigeration cycle".

**Warning!****Refrigerant leak!**

A refrigerant leak involves the danger of serious injury and damage to the environment.



The DRYPOINT® RAX 200-500 NA compressed-air refrigeration dryer contains fluorinated greenhouse gas/refrigerant.



Installation, repair and maintenance works at the refrigeration system must only be carried out by certified skilled personnel (specialists). A certification in accordance with EC regulation 303/2008 must be available.



The requirements of the EC 842/2006 directive must be met under all circumstances.

Please refer to the indications on the name plate as regards the type and amount of refrigerant.



Comply with the following protective measures and rules of conduct:

1. **Storage:** Keep the container tightly closed. Keep it in a cool and dry place. Protect it against heat and direct sunlight. Keep it away from ignition sources.
2. **Handling:** Take measures against electrostatic charging. Ensure good ventilation/suction at the workplace. Check fittings, connections and ducts for tightness. Do not inhale the gas. Avoid contact with the eyes or the skin.
3. Prior to carrying out works on refrigerant-carrying parts, remove the refrigerant to such an extent that safe working is possible.
4. Do not eat, drink or smoke during work. Keep out of the reach of children.
5. **Breathing protection:** ambient-air-independent respirator (at high concentrations).
6. **Eye protection:** sealing goggles.
7. **Hand protection:** protective gloves (e.g. made of leather).
8. **Personal protection:** protective clothing.
9. **Skin protection:** use protective cream.

In addition, the safety data sheet for the refrigerant needs to be observed!

**Caution!****Hot surfaces!**

During operation, several components can reach surface temperatures of more than 140°F (60°C). There is the risk of burns.

All components concerned are installed inside of the closed housing. The housing must only be opened by certified skilled personnel³.

**Caution!****Improper use!**

The device is intended for the separation of water in compressed air. The dried air cannot be used for breathing-air purposes and is not suitable for the direct contact with food.

This dryer is not suitable for the treatment of contaminated air or of air containing solids.

³ Certified skilled personnel are persons who are authorised by the manufacturer, with experience and technical training, who are well-grounded in the respective provisions and laws and capable of carrying out the required works and of identifying and avoiding any risks during the machine transport, installation, operation and maintenance. Qualified and authorised operators are persons who are instructed by the manufacturer regarding the handling of the refrigeration system, with experience and technical training, and who are well-grounded in the respective provisions and laws.



Note!

Contaminated intake air!

In the event that the intake air is strongly contaminated (ISO 8573.1 class 3.-3 or poorer quality), we recommend the additional installation of a prefilter (e.g. CLEARPOINT F040), to avoid clogging of the heat exchanger.



Caution!

Heating-up through fire!

In the event of a heating-up through fire, the containers and pipes of the refrigerant system can burst.



In this case, please proceed as follows:

Switch off the refrigeration plant.

Switch off the mechanical ventilation of the machinery compartment.

Use ambient-air-independent respirators.

Containers and plants which are filled with refrigerant can burst violently in the event of fire.

The refrigerants themselves are incombustible, but they are degraded to very toxic products at high temperatures.

Remove the container/plant from the fire zone, as there is the risk of bursting!

Cool down containers and bottles via a directed water jet from a safe position.

In the event of fire, please use an approved fire extinguisher. Water is not a suitable agent to extinguish an electrical fire.

This must only be carried out by persons who are trained and informed about the hazards emanating from the product.



Caution!

Unauthorised intervention!

Unauthorised interventions may endanger persons and plants and lead to malfunction.

Unauthorised interventions, modification and abuse of the pressure devices are prohibited.

The removal of sealings and leadings at safety devices is prohibited.

Operators of the devices must observe the local and national pressure equipment regulations in the country of installation.



Note!

Ambient conditions!

In the event that the dryer is not installed under suitable ambient conditions, the ability of the device to condense refrigerant gas is impaired. This can result in a higher load of the refrigerating compressor, and in a loss of efficiency and performance of the dryer.

This in turn leads to overheated condenser fan motors, to malfunction of electric components and to a breakdown of the dryer. Failures of this type will affect warranty considerations.

Do not install the dryer in an environment in which chemicals with a corrosive effect, explosive gases, toxic gases, evaporation heat, high ambient temperatures or extreme dust and dirt can be found.

3 Proper use

This dryer was designed, manufactured and tested to separate the moisture which normally exists in compressed air. Any other use is considered improper.

The manufacturer shall not be liable for problems occurring as a consequence of improper use. The user alone is responsible for any damage resulting from that.

Furthermore, the correct use includes the compliance with the installation instructions, in particular in respect of:

- The voltage and frequency of the main voltage supply.
- The pressure, temperature and flow rate of the inlet air.
- The pressure, temperature and cooling-water throughput (water-cooled).
- The ambient temperature.

When delivered, the dryer is tested and fully assembled. The customer only needs to connect the device to the system in accordance with the instructions in the following chapters.

4 Exclusion from a field of application



Note!
Improper use!



The device is intended for the separation of water in compressed air. The dried air cannot be used for breathing-air purposes and is not suitable for the direct contact with food.

This dryer is not suitable for the treatment of contaminated air or of air containing solids.

5 Operating instructions in accordance with the 2014/68/EU Pressure Equipment Directive

The DRYPOINT® RAX 200-500 NA compressed-air refrigeration dryer contains pressure equipment in the sense of the 2014/68/EU Pressure Equipment Directive. Therefore, the entire plant needs to be registered with the supervisory authority if required in accordance with the local regulations.

For the examination prior to the start-up and for periodic inspections, the national regulations need to be observed, such as the industrial safety regulation in the Federal Republic of Germany. In countries outside the EU, the respective regulations in force there need to be adhered to.

The proper use of pressure devices is the basic requirement for safe operation. As regards pressure devices, the following points need to be observed:

- The DRYPOINT® RAX 200-500 NA compressed-air refrigeration dryer must only be employed within the pressure and temperature range limits indicated by the manufacturer on the name plate.
- No welding must be carried out on the pressure parts.
- The DRYPOINT® RAX 200-500 NA compressed-air refrigeration dryer must neither be installed in insufficiently ventilated rooms nor near heat sources or inflammable substances.
- To avoid fractures resulting from material fatigue, the refrigeration dryer should not be exposed to vibrations during operation.
- The maximum operating pressure indicated by the manufacturer on the name plate must not be exceeded. It is the installer's responsibility to install the appropriate safety and control devices. Prior to the start-up of the DRYPOINT® RAX 200-500 NA compressed-air refrigeration dryer, the connected pressure generator (compressor etc.) must be set to the max. permissible operating pressure. The integrated safeguard needs to be checked by an approved inspection agency.
- The documents related to the DRYPOINT® RAX 200-500 NA compressed-air refrigeration dryer (manual, operating instructions, manufacturer's declaration etc.) must be kept safe for future reference.
- No objects whatsoever must be installed at or placed on the DRYPOINT® RAX 200-500 NA compressed-air refrigeration dryer and the connecting lines.
- Installation of the plant in frost-free places only.
- Operation of the plant is only permissible with fully closed and intact housing and cover panels. Operation of the plant with damaged housing/cover panels is prohibited.

6 Transport

Check the packaging for visible loss or damage. If no visible damage can be ascertained, place the unit in close proximity to the place of installation and unpack the device.

During this procedure, the dryer must always remain in an upright position. The components may be damaged when the unit is tilted or turned upside down.

Store the device in a dry environment and do not expose it to extreme weather conditions.

Handle with care. Strong shocks can cause irreparable damage.

7 Storage

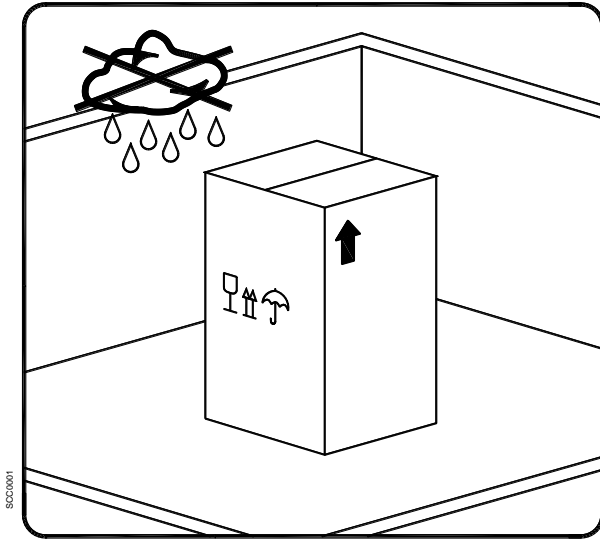

Keep the device away from extreme weather conditions even when packaged.

Keep the dryer in an upright position, also while it is stored. Tilting the device or turning it upside down can cause irreparable damage to some components.

When the dryer is not in use, it can be stored in its packaging in a dust-free and protected place at a temperature of 34 ... 122°F (1 ... 50°C) and at a specific humidity of max. 90%. If the storage period exceeds 12 months, you should contact the manufacturer.



The packaging material is recyclable. Dispose of the material in accordance with the directives and provisions in force in the country of destination

8 Installation

8.1 Place of installation



Note!

Ambient conditions!

In the event that the dryer is not installed under suitable ambient conditions, the ability of the device to condense refrigerant gas is impaired. This can result in a higher load of the refrigerating compressor, and in a loss of efficiency and performance of the dryer.

This in turn leads to overheated condenser fan motors, to malfunction of electric components and to a breakdown of the dryer. Failures of this type will affect warranty considerations.

Do not install the dryer in an environment in which chemicals with a corrosive effect, explosive gases, toxic gases, evaporation heat, high ambient temperatures or extreme dust and dirt can be found.

Minimum installation requirements:

- Choose an area which is clean and dry, free from dust and protected against atmospheric disturbances.
- The load-bearing zone must be even, horizontal and able to bear the weight of the dryer.
- Minimum ambient temperature +34°F (+1°C).
- Maximum ambient temperature +122°F (+50°C).
- Ensure a proper cooling air replacement.
- Allow a sufficient clearance on each side of the dryer for proper ventilation and to facilitate maintenance operations. The dryer does not require attachment to the floor surface.



Do not obstruct the ventilation grille (not even partially).

Prevent any recirculation of the outgoing cooling air.

Protect the dryer against draughts.

8.2 Installation plan

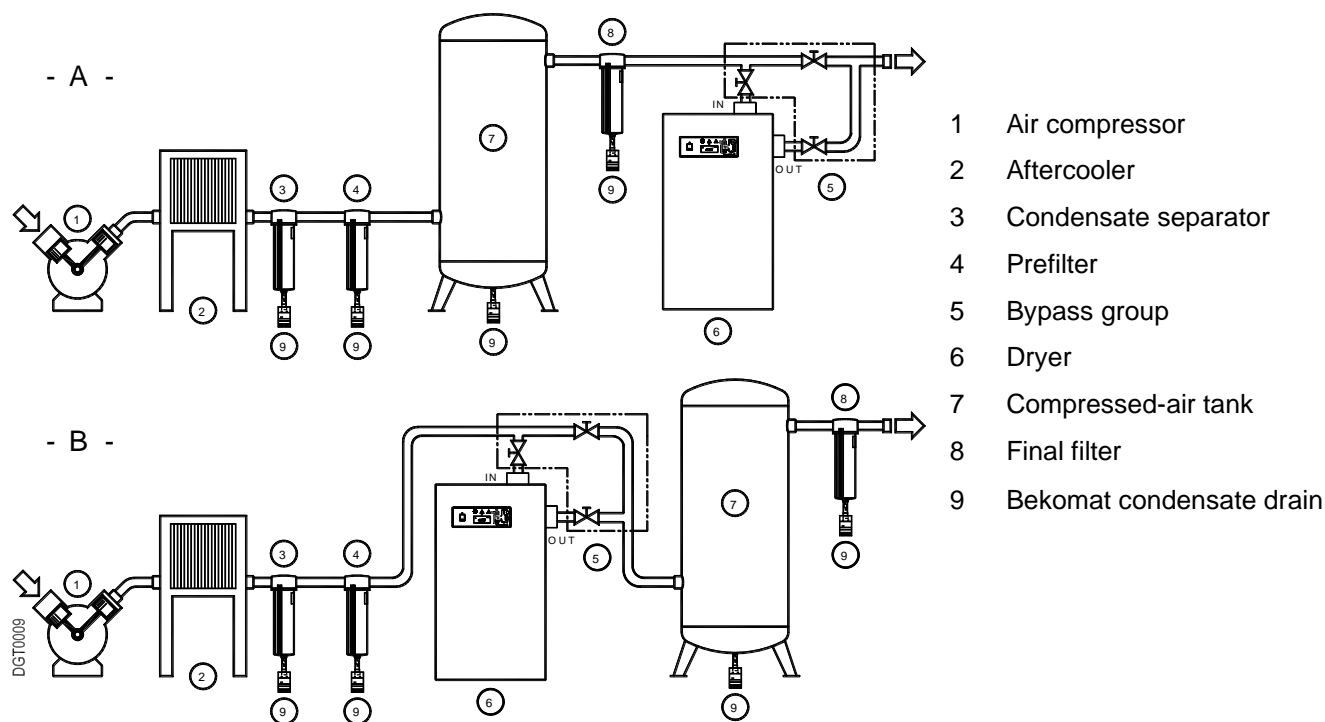

Installation **type A** is recommended when the total consumption corresponds to the throughput rate of the compressor. Installation **type B** is recommended when the air consumption constantly varies, with peak values which considerably exceed the throughput rate of the compressor. The storage capacity of the tank must be dimensioned in such a way that a possible short-term high air demand (peak air consumption) can be compensated.



Do not obstruct the ventilation grille (not even partially).

Prevent any recirculation of the outgoing cooling air.
Protect the dryer against draughts.



Note!

Contaminated intake air!

In the event that the intake air is strongly contaminated (ISO 8573.1 class 3.-3 or poorer quality), we recommend the additional installation of a prefilter (e.g. CLEARPOINT F040), to avoid clogging of the heat exchanger.

Installation

8.3 Correction factors

Correction factor for operating pressure modifications:									
Inlet air pressure	psig	60	80	100	120	140	160	180	203
	barg	4	5.5	7	8	10	11	12	14
Factor (F1)		0.79	0.91	1.00	1.07	1.13	1.18	1.23	1.27

Correction factor for ambient temperature modifications (Air-Cooled):									
Ambient temperature	°F	≤ 80	90	95	100	105	110	115	122
	°C	≤ 27	32	35	38	40	43	45	50
Factor (F2)		1.11	1.09	1.06	1.00	0.94	0.87	0.78	0.69

Correction factor for inlet air temperature modifications:									
Air temperature	°F	≤ 90	100	110	122	130	140	150	158
	°C	≤ 32	38	43	50	55	60	65	70
Factor (F3)		1.16	1.00	0.82	0.68	0.61	0.52	0.45	0.40

Correction factor for DewPoint modifications:									
DewPoint	°F	38	41	45	50				
	°C	3	5	7	10				
Factor (F4)		1.00	1.08	1.20	1.36				

Calculation of the actual air throughput:

Actual air throughput = air throughput acc. to planning x factor (F1) x factor (F2) x factor (F3) x factor (F4)

Example:

The **DRYPOINT RAX 250** has a planned nominal capacity of 250 scfm (425 m³/h). The highest achievable air mass under the following operating conditions is:

- Air inlet pressure = 120 psig (8 barg) ⇒ ⇒ Factor (F1) = 1.07
- Ambient temperature = 115°F (45°C) ⇒ ⇒ Factor (F2) = 0.78
- Air inlet temperature = 122°F (50°C) ⇒ ⇒ Factor (F3) = 0.68
- Pressure dew point = 50°F (10°C) ⇒ ⇒ Factor (F4) = 1.36

Every function parameter corresponds to a numerical factor which, multiplied by the planned nominal capacity, determines the following:

Actual air throughput = 250 x 1.07 x 0.78 x 0.68 x 1.36 = 193 scfm (328 m³/h)

193 scfm (328 m³/h) is the maximum flow rate of the dryer under the aforementioned operating conditions.

Selection of the best suitable model in accordance with the operating conditions:

$$\text{Air throughput acc. to planning} = \frac{\text{Requ. air throughput}}{\text{Factor (F1)} \times \text{Factor (F2)} \times \text{Factor (F3)} \times \text{Factor (F4)}}$$

Example:

The following operating parameters are known:

- Required air mass = 180 scfm (306 m³/h) ⇒ ⇒ Factor (F1) = 1.07
- Air inlet pressure = 120 psig (8 barg) ⇒ ⇒ Factor (F2) = 0.78
- Ambient temperature = 115°F (45°C) ⇒ ⇒ Factor (F3) = 0.68
- Air inlet temperature = 122°F (50°C) ⇒ ⇒ Factor (F4) = 1.36
- Pressure dew point = 50°F (10°C)

To find out the correct dryer version, the required air mass must be divided by the correction factors of the parameters indicated above:

$$\text{Air throughput acc. to planning} = \frac{180}{1.07 \times 0.78 \times 0.68 \times 1.36} = 233 \text{ scfm (396 m³/h)}$$

The suitable model for these requirements is **DRYPOINT RAX 250** (with a spec. nominal capacity of **250 scfm [425 m³/h]**).

8.4 Connection to the compressed-air system



Danger! **Compressed air!**

All works must only be carried out by qualified skilled personnel.

Never work on compressed-air systems which are under pressure.



The operator or the user must ensure that the dryer is never operated with a pressure exceeding the maximum pressure value indicated on the name plate.

Exceeding the maximum operating pressure can be dangerous for the operator but also for the device.

The air temperature and the air flow at the inlet of the dryer must lie within the limit values indicated on the name plate. The connecting lines must be free from dust, iron rust, shards and other contaminations and correspond to the flow rate of the dryer. Should air with a very high temperature be treated, the installation of an aftercooler may be necessary. For the implementation of maintenance works, the installation of a bypass system is recommended.

The dryer was designed in such a manner that vibrations that may occur during operation are limited. Therefore, it is advisable to employ connecting lines (flexible hoses, vibration-inhibiting fittings etc.) which protect the dryer against possible vibrations in the pipework.

Note!



Contaminated intake air!

In the event that the intake air is strongly contaminated (ISO 8573.1 class 3.-3) or poorer quality, we recommend the additional installation of a prefilter (e.g. CLEARPOINT F040), to avoid clogging of the heat exchanger.

CAUTION!



During the piping of the dryer, the inlet and outlet connections need to be supported as is shown in the illustration.

Non-observance will cause damage.

8.5 Connection to the cooling-water network



Danger! **Compressed air and unqualified personnel!**

All works must only be carried out by qualified skilled personnel.

Never work on compressed-air systems which are under pressure.



The user must ensure that the dryer is never operated with a pressure exceeding the nominal values.

Possible overpressure can be dangerous for the operator but also for the device.

The temperature and the amount of cooling water need to correspond to the limit values indicated on the name plate. The cross-section of the connecting lines, which should preferably be flexible, must be free from dust, iron rust, shards and other contaminations. We recommend employing connecting lines (flexible hoses, vibration-inhibiting fittings etc.) which protect the dryer against possible vibrations in the pipework.

Note!



Contaminated intake water!

In the event that the intake water is strongly contaminated we recommend the additional installation of a prefilter (500 micron), to avoid clogging of the heat exchanger.

CAUTION!



During the piping of the dryer, the inlet and outlet connections need to be supported as is shown in the illustration.

Non-observance will cause damage.

8.6 Minimum cooling water requirements:

Temperature	15 ... 30°C (1)	Residual solid particles	<30 mg/l or ppm
Pressure	3...10 bar(g) (2)	Cl ⁻	<5 mg/l or ppm
Delivery pressure	> 3 bar (2) (3)	Cl ₂	<0.5 mg/l or ppm
PH	7.5...9.0	Oxygen content	<0.1 mg/l or ppm
Total hardness	6.0...15 °dH	CO ₂	<50 mg/l or ppm
Conductivity	10...500 µS/cm or µmho/cm	H ₂ S	<0.05 mg/l or ppm
SO ₄ ²⁻	<100 mg/l or ppm	PO ₄ ³⁻	<2 mg/l or ppm
HCO ₃ ⁻ / SO ₄	>1.0 mg/l or ppm	Fe	<0.2 mg/l or ppm
NH ₃	<0.5 mg/l or ppm	Mn	<0.1 mg/l or ppm
Free aggressive carbonic acid	<20 mg/l or ppm	NO ₃ ⁻	<100 mg/l or ppm
NH ₄ ⁺	<2 mg/l or ppm	NO ₂ ⁻	<0.1 mg/l or ppm
Saturation mark SI	-0.2 < 0 < 0.2	S ²⁻	<1 mg/l or ppm
HCO ₃	<300 mg/l or ppm		

Note:

- (1) – Other temperatures upon request – check the data on the name plate.
- (2) – Other pressures upon request – check the data on the name plate.
- (3) – Pressure difference at the water connection of the dryer at maximum water flow. Other delivery pressures upon request.

8.7 Electrical connections



**Danger!
Supply voltage!**

The connection to the electric mains should only be carried out by qualified skilled personnel and must correspond to the legal provisions in force in your region.

Prior to connecting the device, please check the name plate to avoid exceeding the indicated values. The voltage tolerance is +/- 10%.

DRYPOINT RAX 200-500 NA 3PH dryers are supplied with a junction box on the back plate.

Make sure that suitable fuses or circuit breakers in accordance with the indications on the name plate are available.

A residual-current device (RCD) with IΔn =0.03A is suggested. The cross-section of the power supply cable must correspond to the power consumption of the dryer. In this respect, the ambient temperature, the cable laying conditions, the length of the cables and the requirements of the local electricity supplier need to be considered.



**Danger!
Supply voltage and missing earth connection!**

Important: ensure that the plant is connected to earth.

Do not use plug adapters at the power plug.

Possible replacement of the power plug must only be carried out by a qualified electrician.

8.8 Condensate drain



Danger!

Compressed air and condensate under pressure!

The condensate is discharged at system pressure.

The drain pipe needs to be secured.



Never direct the condensate drain pipe at persons.

The dryer is delivered with an already integrated electronically level-controlled BEKOMAT condensate drain. Connect the condensate drain with a collection system or container by properly screwing it on.

Do not connect the drain with pressurised plants.



Do not discharge the condensate into the environment.

The condensate accumulating in the dryer contains oil particles which were released into the air by the compressor.

Dispose of the condensate in accordance with the local provisions.

It is advisable to install a water-oil separator, to which the total amount of condensate from the compressors, dryers, tanks, filters etc. is supplied.

We recommend ÖWAMAT oil-water separators for dispersed compressor condensate and BEKOSPLIT emulsion-splitting plants for emulsified condensate.

9 Start-up

9.1 Preliminary stages



Note!

Exceeding of the operating parameters!

Ensure that the operating parameters comply with the nominal values indicated on the name plate of the dryer (voltage, frequency, air pressure, air temperature, ambient temperature etc.).

Prior to delivery, this dryer was thoroughly tested, packed and checked. Please verify the soundness of the dryer during the initial start-up and check the perfect functioning during the first operating hours.



The initial start-up must be carried out by qualified personnel.

During the installation and operation of this device, all national regulations regarding electronics and any other federal and state ordinances, as well as local provisions, need to be adhered to.



The operator and the user must ensure that the dryer is not operated without panels.

9.2 Initial start-up



Note!

The dryer **must not be started up more than six times an hour**. Wait at least five minutes prior to every restart.

The user is responsible for the compliance with these provisions. Irreparable damage can be caused by starting up the device too often.



The method below should be applied during the first start-up, after longer downtimes or subsequent to maintenance works.

The start-up must be carried out by certified skilled personnel.

Processing sequence (see Section 11.1 "Control panel")

- Ensure that all steps of the "Installation" chapter have been carried out.
- Ensure that the connection to the compressed-air system is in accordance with the provisions and that the lines are fixed and supported properly.
- Ensure that the condensate drain pipe is fixed in accordance with the provisions and that it is connected with a collection system or a container.
- Ensure that the bypass system (if installed) is open and that the dryer is disconnected from the compressed-air system.
- Ensure that the manual valve of the condensate drainage cycle is open.
- Remove any packaging material and other items which may block the space around the dryer.
- Establish the mains connection (plug into socket).
- Switch on the main switch - pos. A control panel.
- Wait at least two hours before starting the dryer (the crankcase heater of the compressor needs to heat up the compressor oil).
- Start the dryer by switching on the main switch on the control panel (pos. 1).
- Make sure that the electronic control unit is switched on.
- Ensure that the power consumption complies with the values on the name plate.
- **Ensure that the fan runs properly – wait for the first interventions.**
- Wait until the dew point remains stable.
- Slowly open the air inlet valve.
- Slowly open the air outlet valve.
- Slowly close the central bypass valve of the system (if installed).
- Check the pipes for air leakage.
- Ensure the proper functioning of the condensate drain cycle (wait for the first condensate discharges).



Note!

A dew point between 32°F (0°C) and +50°F (+10°C) displayed on the electronic control unit is considered to be correct according to the possible operating conditions (flow rate, air inlet temperature, ambient temperature etc.).

During the operation, the refrigerating compressor runs continuously. The dryer needs to be switched on during the entire compressed-air usage time, even if the compressed-air compressor works periodically.

9.3 Shut down and restart



During short-term inactivity (max. two to three days), it is advisable to leave the dryer and the control panel connected to the supply current circuit. Otherwise, it would be necessary at a restart of the dryer to wait two hours, until the crankcase heater of the compressor has heated up the oil in the compressor.



Shut down (see Section 11.1 "Control panel")

- Ensure that the dew point temperature indicated on the electronic control unit is stable.
- Interrupt the compressed-air supply.
- After a few minutes, stop the dryer by switching off the main switch on the control panel (pos. 1).



Restart (see Section 11.1 "Control panel")

- Make sure that the condenser is clean (air-cooled).
- Ensure that the cooling-water flow and the temperature are in accordance with the provisions (water-cooled).
- Check whether or not voltage is applied at the dryer.
- Start the dryer by switching on the main switch on the control panel (pos. 1).
- Ensure that the electronic control unit is switched on.
- Wait a few minutes and then check, whether or not the dew point temperature indicated on the electronic control unit is stable and whether or not the condensate is drained off at regular intervals.
- Establish the compressed-air supply.



Dryer remote control ON/OFF

- Remove the jumper between terminals 1 and 2 of the terminal strip and wire a potential-free contact (see electric diagram).
- Switch ON the main switch - pos. 1 on the control panel.
- Close the contact at terminals 1 and 2 to switch on the dryer.
- Open the contact at terminals 1 and 2 to switch off the dryer.



Only use potential-free contacts that are suitable for 230Vac. Ensure the sufficient insulation of potentially dangerous voltage-carrying components.



Caution!

**Automatic restart / remote control ON/OFF. The unit may start up without any active influence!
The user will be responsible for the installation of proper protections for possible sudden power restoration to the dryer.**



Note!

A dew point 32°F (0°C) and +50°F (+10°C) displayed on the electronic control unit is considered to be correct according to the possible operating conditions (flow rate, air inlet temperature, ambient temperature etc.).

During the operation, the refrigerating compressor runs continuously. The dryer needs to be switched on during the entire compressed-air usage time, even if the compressed-air compressor works periodically.



Note!

The dryer **must not be started up more than six times an hour**. Wait at least five minutes prior to every restart.

The user is responsible for the compliance with these provisions. Irreparable damage can be caused when starting up the device too often.

10 Technical data

10.1 Technical data DRYPOINT RAX 200-500 NA 3phase 3/460/60

MODEL	DP RAX NA	200-R	250-R	300-R	350-R	400-R	500-R
Air flow rate at nominal condition (1)	[scfm]	200	250	300	350	400	500
	[m3/h]	340	425	509	594	679	849
	[l/min]	5660	7075	8490	9905	11320	14150
Pressure DewPoint at nominal condition (1)	[°F (°C)]	38 (3)					
Nominal ambient temperature	[°F (°C)]	100 (38)					
Min...Max ambient temperature	[°F (°C)]	34...122 (1...50)					
Nominal inlet air temperature	[°F (°C)]	100 (38) max:158 (70)					
Nominal inlet air pressure	[psig (barg)]	100 (7)					
Max. inlet air pressure	[psig (barg)]	203 (14)					
Air pressure drop - Δp	[psi (bar)]	1.7 (0.12)	3.6 (0.25)	1.5 (0.10)	1.9 (0.13)	1.0 (0.07)	1.5 (0.10)
Inlet - Outlet connections	[NPT-F]	1.1/2"		2"		2.1/2"	

Air-Cooled	Refrigerant type	R134.a				R407C		
	Refrigerant quantity (2)	[oz (kg)]	37 (1.05)	41 (1.15)	60 (1.70)	63 (1.80)	74 (2.10)	81 (2.30)
	Cooling air fan flow	[cfm (m3/h)]	1500 (2500)	1650 (2800)		1700 (2900)	2100 (3600)	2200 (3700)
	Heat Rejection	[btu/hr (kW)]	13700 (4.02)	14200 (4.16)	14900 (4.37)	18200 (5.33)	24900 (7.30)	32300 (9.47)
	Standard Power Supply (2)	[Ph/V/Hz]	3/460/60					
	Nominal electric consumption	[kW]	1.22	1.38	1.41	1.80	2.70	2.97
		[A]	1.9	2.1	2.2	2.8	4.2	4.5
	Full Load Amperage FLA	[A]	2.8			4.5	6.4	7.4
	Max. noise level at 1 m	[dbA]	< 70					
	Weight	[lb (kg)]	159 (72)	176 (80)	238 (108)	243 (110)	353 (160)	375 (170)

Water-Cooled	Refrigerant type	R134.a				R407C		
	Refrigerant quantity (2)	[oz (kg)]	33 (0.95)	37 (1.05)	55 (1.55)	56 (1.60)	67 (1.90)	74 (2.10)
	Max. cooling water inlet temp (3)	[°F (°C)]	86 (30)					
	Min...Max. cooling water inlet pressure	[psig (barg)]	45...145 (3...10)					
	Cooling water flow at 15°C	[US gpm (m3/h)]	0.48 (0.11)	0.57 (0.13)	0.62 (0.14)	0.70 (0.16)	0.84 (0.19)	0.97 (0.22)
	Cooling water flow at 30°C	[US gpm (m3/h)]	1.89 (0.43)	2.03 (0.46)	2.33 (0.53)	2.55 (0.58)	3.17 (0.72)	3.48 (0.79)
	Heat Rejection	[btu/hr (kW)]	13700 (4.02)	14200 (4.16)	14900 (4.37)	18200 (5.33)	24900 (7.30)	32300 (9.47)
	Control of cooling water flow		Automatic by valve					
	Cooling water connection	[NPT-F]	1/2"				3/4"	
	Standard Power Supply (2)	[Ph/V/Hz]	3/460/60					
	Nominal electric consumption	[kW]	1.03	1.19	1.24	1.62	2.16	2.38
		[A]	1.8		1.9	2.4	2.8	3.7
	Full Load Amperage FLA	[A]	2.2			3.9	5.1	6.1
Max. noise level at 1 m	[dbA]	< 70						
Weight	[lb (kg)]	152 (69)	170 (77)	231 (105)	236 (107)	353 (160)	368 (167)	

(1) The nominal condition refers to an ambient temperature of 100°F (38°C) with inlet air at 100 psig (7 barg) and 100°F (38°C).

(2) Check the data shown on the identification plate.

(3) Other temperature on request.

10.2 Technical data DRYPOINT RAX 200-500 NA 3phase 3/575/60

MODEL	DP RAX NA	200-Q	250-Q	300-Q	350-Q	400-Q	500-Q
Air flow rate at nominal condition (1)	[scfm]	200	250	300	350	400	500
	[m3/h]	340	425	509	594	679	849
	[l/min]	5660	7075	8490	9905	11320	14150
Pressure DewPoint at nominal condition (1)	[°F (°C)]	38 (3)					
Nominal ambient temperature	[°F (°C)]	100 (38)					
Min...Max ambient temperature	[°F (°C)]	34...122 (1...50)					
Nominal inlet air temperature	[°F (°C)]	100 (38) max.158 (70)					
Nominal inlet air pressure	[psig (barg)]	100 (7)					
Max. inlet air pressure	[psig (barg)]	203 (14)					
Air pressure drop - Δp	[psi (bar)]	1.7 (0.12)	3.6 (0.25)	1.5 (0.10)	1.9 (0.13)	1.0 (0.07)	1.5 (0.10)
Inlet - Outlet connections	[NPT-F]	1.1/2"		2"		2.1/2"	

Air-Cooled	Refrigerant type	R134.a				R407C		
	Refrigerant quantity (2)	[oz (kg)]	37 (1.05)	41 (1.15)	60 (1.70)	63 (1.80)	74 (2.10)	81 (2.30)
	Cooling air fan flow	[cfm (m3/h)]	1500 (2500)	1650 (2800)		1700 (2900)	2100 (3600)	2200 (3700)
	Heat Rejection	[btu/hr (kW)]	13700 (4.02)	14200 (4.16)	14900 (4.37)	18200 (5.33)	24900 (7.30)	32300 (9.47)
	Standard Power Supply (2)	[Ph/V/Hz]	3/575/60					
	Nominal electric consumption	[kW]	1.22	1.38	1.41	1.80	2.70	2.97
		[A]	1.5	1.7	1.8	2.2	3.4	3.6
	Full Load Amperage FLA	[A]	2.2		3.6		5.1	5.9
	Max. noise level at 1 m	[dbA]	< 70					
	Weight	[lb (kg)]	159 (72)	176 (80)	238 (108)	243 (110)	353 (160)	375 (170)

Water-Cooled	Refrigerant type	R134.a				R407C		
	Refrigerant quantity (2)	[oz (kg)]	33 (0.95)	37 (1.05)	55 (1.55)	56 (1.60)	67 (1.90)	74 (2.10)
	Max. cooling water inlet temp (3)	[°F (°C)]	86 (30)					
	Min...Max. cooling water inlet pressure	[psig (barg)]	45...145 (3...10)					
	Cooling water flow at 15°C	[US gpm (m3/h)]	0.48 (0.11)	0.57 (0.13)	0.62 (0.14)	0.70 (0.16)	0.84 (0.19)	0.97 (0.22)
	Cooling water flow at 30°C	[US gpm (m3/h)]	1.89 (0.43)	2.03 (0.46)	2.33 (0.53)	2.55 (0.58)	3.17 (0.72)	3.48 (0.79)
	Heat Rejection	[btu/hr (kW)]	13700 (4.02)	14200 (4.16)	14900 (4.37)	18200 (5.33)	24900 (7.30)	32300 (9.47)
	Control of cooling water flow		Automatic by valve					
	Cooling water connection	[NPT-F]	1/2"				3/4"	
	Standard Power Supply (2)	[Ph/V/Hz]	3/575/60					
Nominal electric consumption	[kW]	1.25	1.44	1.50	1.96	2.61	2.88	
	[A]	1.4		1.5	1.9	2.2	3.0	
Full Load Amperage FLA	[A]	1.8			3.1	4.1	4.9	
Max. noise level at 1 m	[dbA]	< 70						
Weight	[lb (kg)]	152 (69)	170 (77)	231 (105)	236 (107)	353 (160)	368 (167)	

(1) The nominal condition refers to an ambient temperature of 100°F (38°C) with inlet air at 100 psig (7 barg) and 100°F (38°C).

(2) Check the data shown on the identification plate.

(3) Other temperature on request.

11 Technical description

11.1 Control panel

The control panel explained below is the only dryer user interface.

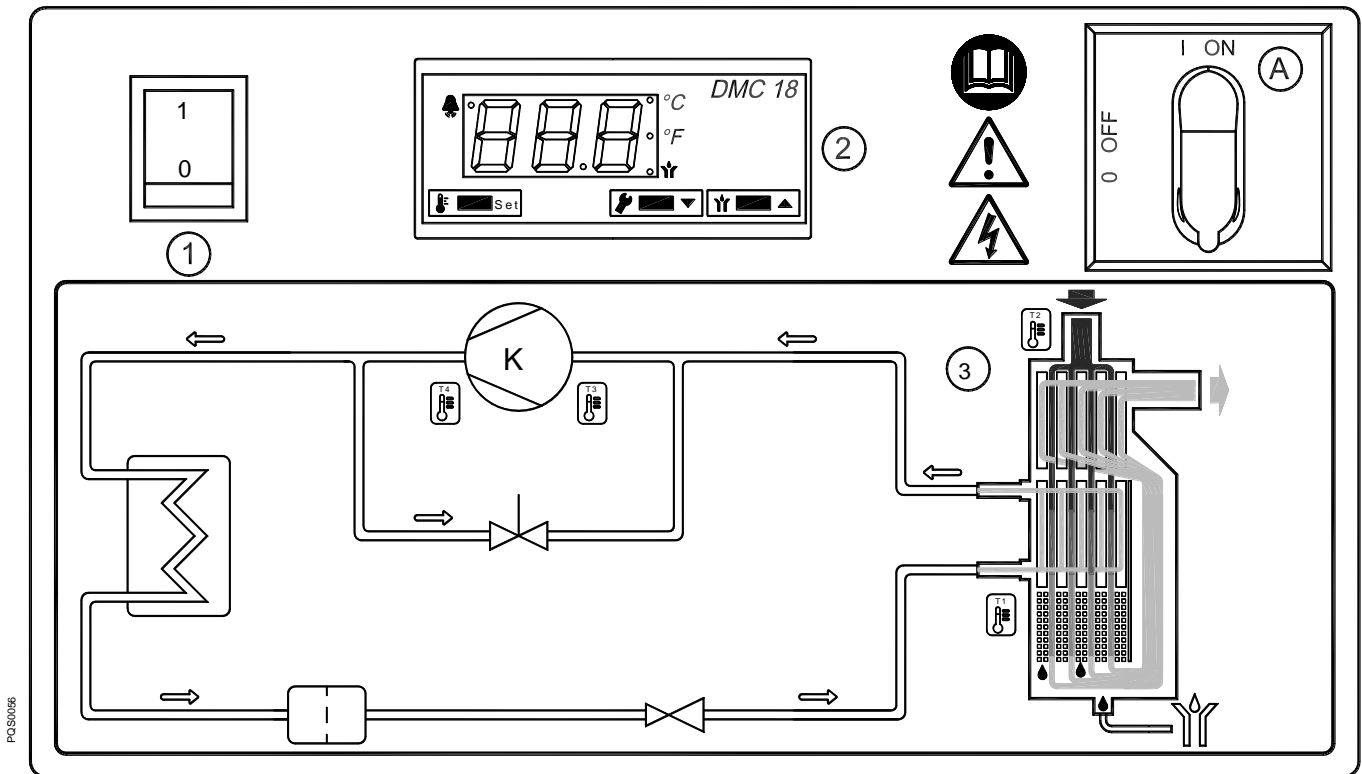

- A Main switch
- 1 ON-OFF switch
- 2 Electronic control unit DMC18
- 3 Air and refrigerant-gas flow chart

11.2 Functional description

Operating principle – All dryer models described in this manual function according to the same principle. The hot and moisture-loaded air is led into an air/air heat exchanger. Afterwards, the air flows through an evaporator, which is also known as an air/refrigerant heat exchanger. The air temperature is reduced to approximately 36°F (2°C), so that water vapour condenses to liquid. The continuously accumulating condensate is collected in the separator to be discharged via the condensate drain. Subsequently, the cold and dry air is led through the air/air heat exchanger, so that it is reheated to up to 46°F (8°C) below the inlet temperature when leaving the dryer.

Refrigeration cycle – The refrigerant is conducted through the compressor and reaches a condenser under high pressure. There, cooling-down takes place, making the refrigerant condense to a liquid state which is under high pressure. The liquid is pressed through a capillary tube where the resulting pressure drop ensures that the refrigerant evaporates at a defined temperature. The liquid refrigerant which is under low pressure is led into the heat exchanger, where it expands. The cold resulting from the expansion serves to cool down the compressed air in the heat exchanger. During this process, the refrigerant evaporates. The low-pressure gas is resupplied to the compressor, where it is compressed again. It then re-enters the cycle. In phases of a reduced compressed-air load, the excess refrigerant is resupplied automatically to the compressor via the hot gas bypass valve.

11.3 Flow chart (air-cooled)

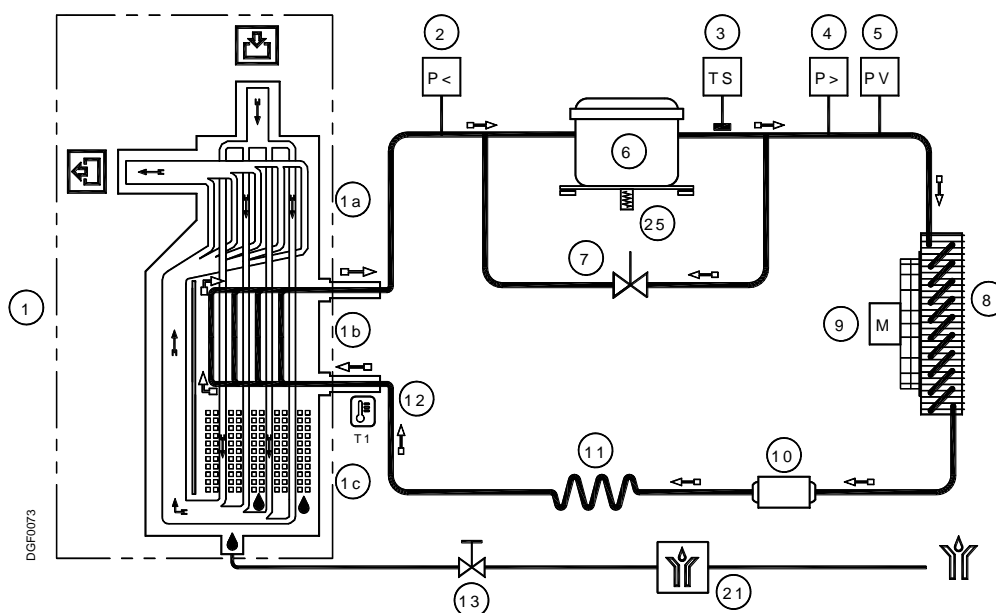

11.4 Flow chart (water-cooled)

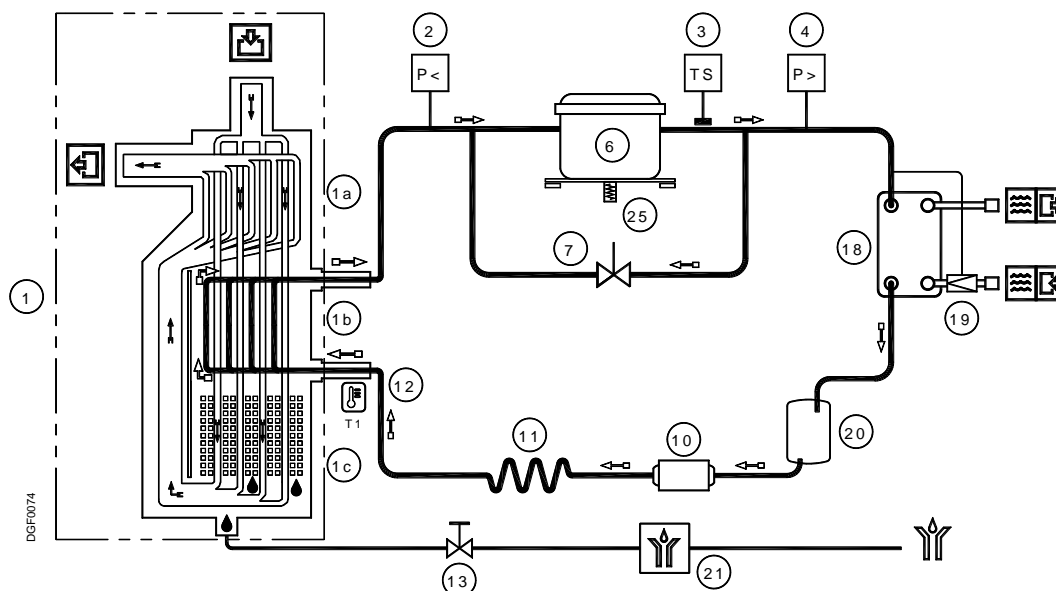

- | | |
|--|--|
| 1 Aluminium heat exchanger module | 9 Condenser fan (air cooled) |
| a – Air/air heat exchanger | 10 Filter dryer |
| b – Air/refrigerant heat exchanger | 11 Capillary tube |
| c – Condensate separator | 12 T1 temperature sensor (dew point) |
| 2 Refrigerant pressure switch LPS (P<) | 13 Condensate drain shut-off valve |
| 3 Safety temperature switch TS | 18 Condenser (water-cooled) |
| 4 Refrigerant pressure switch HPS (P>) | 19 Cooling-water regulating valve (water-cooled) |
| 5 Refrigerant fan pressure switch PV | 20 Liquid collector (water-cooled) |
| 6 Refrigerating compressor | 21 BEKOMAT condensate drain |
| 7 Hot-gas bypass valve | 25 Compressor crankcase heater |
| 8 Condenser (air-cooled) | |
| ⇒ Compressed-air flow direction | ⇒ Refrigerant gas flow direction |

Technical description

11.5 Refrigerating compressor

The employed refrigerating compressors are constructed by leading manufacturers. The hermetically sealed construction is absolutely gastight. The integrated safeguard protects the compressor against overheating and excess current. The protection is automatically reset as soon as the nominal conditions are reached again.

11.6 Condenser (air-cooled)

The condenser is the component in which the gas coming from the compressor is cooled down, condensed and liquefied. Under no circumstances must the temperature of the ambient air exceed the nominal values. It is also important that the condenser unit is kept free from dust and other impurities.

11.7 Condenser (water-cooled)

The condenser is the component in which the gas coming from the compressor is cooled-down, condensed and liquefied. The water inlet temperature must not exceed the nominal values. Likewise, a correct flow must be ensured. The water entering the condenser must be free from impurities.

11.8 Cooling-water regulating valve

The cooling-water regulating valve serves to keep the condensation pressure or the condensation temperature constant during water cooling. When the dryer is switched off, the valve automatically blocks the cooling-water flow.



The condenser water regulating valve is an operating control device. The closure of the water circuit from the pressure condenser water regulating valve cannot be used as a safety closure during service operations on the system.



ADJUSTMENT

The condenser water regulating valve is adjusted during the testing phase to a pre-set value that covers 90% of the applications. However, sometimes the extreme operating conditions of the dryer may require a more accurate calibration.

During start-up, a qualified technician should check the condensing pressure/temperature and if necessary adjust the valve by using the screws on the valve itself.

To increase the condensing temperature, turn the adjusting screws counter-clockwise; to lower it turn the screws clock-wise.

Water valve setting : R134.a pressure 145 psig (± 7.3 psi) [10 barg (± 0.5 bar)]
R407C pressure 232 psig (± 7.3 psi) [16 barg (± 0.5 bar)]

11.9 Filter dryer

Despite controlled vacuuming, traces of moisture can accumulate in the refrigeration cycle. The filter dryer serves to absorb this moisture and to bond it.

11.10 Capillary tube

The capillary tube is a copper tube with a reduced diameter which is located between the condenser and the evaporator, serving as a restrictor to reduce the pressure of the refrigerant. The pressure reduction serves to reach an optimum temperature inside of the evaporator. The lower the outlet pressure at the capillary tube, the lower the evaporation temperature.

The length and the inner diameter of the capillary tube are exactly dimensioned to ensure the performance of the dryer. Settings or maintenance works are not required.

11.11 Aluminium heat exchanger

The heat exchanger module consists of an air/air heat exchanger, an air/refrigerant heat exchanger, and of a high-performance separator. The compressed air flows top-down through the heat exchanger. The large cross-sections of the flow passages cause low flow rates and low compressed-air losses. In the air/air heat exchanger, the heat exchange is effected in a reverse current. This guarantees maximum heat transfer. The heat transfer in the air/refrigerant heat exchanger also takes place in a reverse current. This allows full evaporation of the refrigerant. The high-performance separator ensures almost complete separation of the condensate. Maintenance of the high-performance separator is not required.

11.12 Hot-gas bypass valve

At partial load, the valve directly returns a part of the hot gas to the suction line of the refrigerating compressor. The evaporation temperature and the evaporation pressure remain constant.



ADJUSTMENT

The hot gas by-pass valve is adjusted during the manufacturing testing phase. As a rule no adjustment is required; anyway if it is necessary the operation must be carried out by an experienced refrigerating engineer.

WARNING

the use of 1/4" Schrader service valves must be justified by a real malfunction of the refrigerating system. Each time a pressure gauge is connected, a part of refrigerant is exhausted.

Without compressed air flow through the dryer, rotate the adjusting screw (position A on the drawing) until the following value is reached:

Hot gas setting :

R134.a pressure 29.0 psig (+ 1.45 / -0 psi) [2.0 barg (+0.1 / -0 bar)]

R407C pressure 65.3 psig (+1.45 / -0 psi) [4.5 barg (+0.1 / -0 bar)]

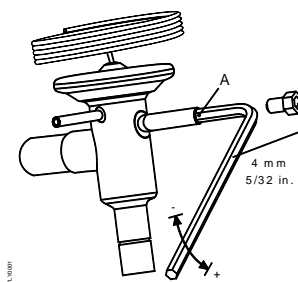

11.13 Refrigerant pressure switches LPS – HPS – PV

To ensure the operational reliability and the protection of the dryer, a series of pressure switches are installed in the gas cycle.

LPS : Low-pressure guard on the suction side of the compressor, which is triggered when the pressure drops below the predetermined value. The values are reset automatically as soon as the nominal conditions are re-established.

Calibrated pressure : R 134.a Stop 10.2 psig (0.7 barg) - Restart 24.7 psig (1.7 barg)
R 407 C Stop 24.7 psig (1.7 barg) - Restart 39.2 psig (2.7 barg)

HPS : The high-pressure control unit on the discharge side of the compressor is activated when the pressure exceeds the predetermined value. It has a manual reset button on the control itself.

Calibrated pressure : R 134.a Stop 290 psig (20 barg) - Manual reset P<203 psi (P<14 bar)
R 407 C Stop 435 psig (30 barg) - Manual reset P<334 psi (P<23 bar)

PV : Fan control pressure switch which is installed on the discharge side of the compressor. It keeps the condensation temperature and pressure constantly in the range of the preadjusted limit values

Calibrated pressure : R 134.a Start 160 psig (+7.25 / -0 psi) [11 barg (+0.5 / -0 bar)]
Stop 116 psig (+0 / -7.25 psi) [8 barg (+0 / -0.5 bar)]
R 407 C Start 261 psig (+7.25 / -0 psi) [18 barg (+0.5 / -0 bar)]
Stop 203 psig (+0 / -7.25 psi) [14 barg (+0 / -0.5 bar)]

11.14 Safety temperature switch TS

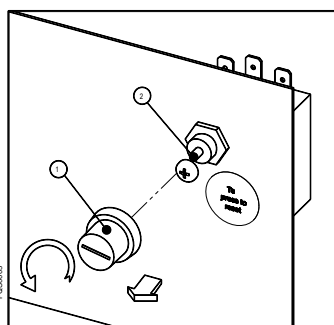

To ensure the operational safety and the soundness of the dryer, a safety temperature switch (TS) is installed at the refrigeration cycle. In the event that the pressure gas temperature is too high, the sensor of the temperature switch will stop the refrigerating compressor to prevent the pressure gas temperature getting too high.

The temperature switch is reset manually, but only when the normal operating conditions are reached again. Unscrew the cover (see pos. 1 in the illustration) and press the reset button (see position 2 in the illustration).

TS setting : temperature 235,4°F (113°C) (+0 / -6 °K)

11.15 Compressor crankcase heater

At low temperatures, the oil can more easily intermix with the refrigerant gas. When the compressor starts, oil can be drawn into the refrigeration cycle, leading to "hydraulic shocks".

To prevent this, a resistance heater is installed in the suction side of the compressor. When the system is connected with the electric mains and the compressor is idle, the heater will keep the oil at the correct temperature.

This heater is controlled via a temperature switch which prevents the overheating of the oil.

Note: The heater must be connected to the mains at least a few hours prior to the start-up of the refrigerating compressor.

11.16 DMC18 electronic control unit

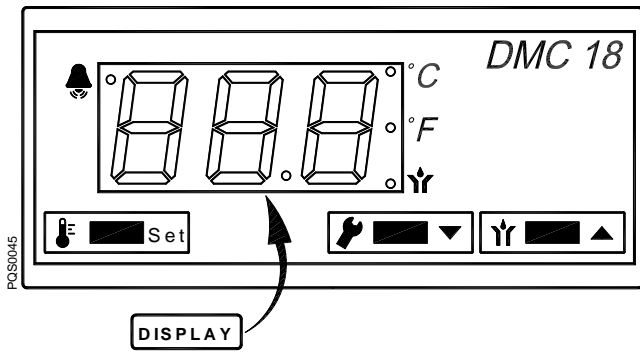

- Led - temperature in °C
- Led - temperature in °F
- Led – drain ON
- Led – alarm/service
- Button – access configuration menu
- Button – decrease / service
- Button – increase / drain test

The DMC18 controls the alarms and the settings of the dryer operation and of the BEKOMAT drain.

11.16.1 Switching the dryer on

Connect the dryer to the electric mains and switch it on via the ON/OFF switch (pos. 1 Section 11.1). During normal operation, the display shows the dew point temperature.

The condensate drain test is always possible via the button.

11.16.2 Switching the dryer off

Switch the device off via the ON/OFF switch (pos. 1 Section 11.1).

11.16.3 Indication of the operating parameters

During normal operation, the display shows the dew point temperature (in °C or °F).

Press the button and keep it pressed to display the **HdS** parameter (alarm release temperature at a high dew point).

Press the button and keep it pressed to display the hours remaining until the next maintenance.

Press the + buttons and keep them pressed to display the total number of operating hours of the dryer.

Note: The temperatures are indicated in °C or °F (LED or is on). The total operating hours and the hours until the next maintenance are indicated in the field 0...999 hours, and in thousand hours from 1.0 hours onwards (example: when the display shows 35, this means 35 hours and when the display shows 3.5, this means 3,500 hours).

11.16.4 Indication of a service warning/service alarm

A service warning/alarm is an exceptional event and requires the attention of the operator/service technician. The dryer will not be stopped.

When a service warning/alarm is active, the LED flashes.

The display successively shows the dew point temperature and the active service warnings/alarms.

Service warnings/alarms are automatically reset as soon as the problem has been eliminated, except for **SrV** (maintenance time expired), where manual resetting is required (press the button and keep it pressed for at least 20 seconds).



NOTE: the operator/service technician must check the dryer and eliminate the problem that led to the activation of the service warning.



Service warning alarm	Description
PF	PF – Probe failure: failure temperature probe
HdP	HdP – High dew point: dew point too high, higher than the adjusted HdS value.
LdP	LdP – Low dew point: dew point too low, lower than the adjusted LdS value.
drA	drA - Drain: failure Bekomat IF condensate drain - delay 20 minutes
SrV	SrV - Service: maintenance service time expired SrV

NOTE: when the dryer is switched on but no system pressure is applied, the **drA drain trouble indication may appear.**

11.16.5 Operation of the potential-free failure/alarm contact

The DMC18 is equipped with a potential-free contact to indicate failures or alarm conditions.

  Dryer is switched on and no service warning/alarm is active.

  Dryer is off or a service warning/alarm is active.



11.16.6 How to change operating parameters – SETUP menu



The setup menu can be used to change the dryer’s operating parameters.

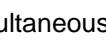

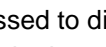
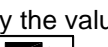
Only qualified personnel must be allowed to access to the setup menu. The manufacturer is not responsible for malfunctioning or failure due to modification to the operating parameters.

With dryer ON simultaneously press buttons  +  for at least 5 seconds to enter the setup menu. Access to the menu is confirmed by message **HdS** on the display (first parameter of menu).

Keep  pressed to display the value of the selected parameter and use arrows  and  to change the value. Release the button  to confirm the value and skip to following parameter.

Press  +  to exit setup menu (if no button is pressed after 30 seconds the menu is exited automatically).

ID	Description	Limits	Resolution	Standard setup
HdS	HdS - High DewPoint Setting : Alarm threshold for a high DewPoint (the alarm disappears when the temperature drop 0.5°C / 1°F below alarm point)	0.0...25.0 °C or 32 ... 77 °F	0.5 °C or 1 °F	20 or 68
Hdd	Hdd - High DewPoint Delay : high DewPoint alarm enable delay	01 ... 20 minutes	1 min	15
LdS	LdS - Low DewPoint Setting : Alarm threshold for a low DewPoint (the alarm disappears when the temperature becomes 0.5°C / 1°F higher than the alarm point)	-10 ... 0.0 °C or 14 ... 32 °F	0.5 °C or 1 °F	-5 or 23
Ldd	Ldd – Low DewPoint Delay : low DewPoint alarm enable delay	01 ... 20 minutes	1 min	5
SrV	SrV - Service Setting: setting of service warning timer. 00 = service warning timer disabled.	0.0 ... 9.0 (x 1000) hours	0.5 (x1000) hours	8.0
SCL	SCL - Scale: display scale of temperatures.	°C ... °F	-	°F

11.16.7 Selection of the BEKOMAT drain model

The DMC18 controls two types of BEKOMAT drains.



The correct settings are carried out in the factory and proper functioning is checked during the final inspection of the dryer.

11.17 Electronically level-controlled BEKOMAT condensate drain

The electronically level-controlled BEKOMAT condensate drain boasts a special condensate management which ensures that condensate is discharged safely and without an unnecessary loss of compressed air. This drain has a condensate collection container in which a capacitive sensor continuously monitors the liquid level. As soon as the switching level is reached, the capacitive sensor transmits a signal to the electronic control and a membrane solenoid valve opens to discharge the condensate. The BEKOMAT closes before compressed air emerges.



Note!

These BEKOMAT condensate drains were designed in particular for the operation in a **DRYPOINT RAX** refrigeration dryer. The installation in other compressed-air processing systems or the replacement with another drain brand can lead to malfunction. The maximum operating pressure (see name plate) must not be exceeded!

Ensure that the upstream valve is open when the dryer starts operation.

To obtain detailed information regarding drain functions, troubleshooting, maintenance and spare parts, please read the installation and operating instructions of the BEKOMAT condensate drain.

12 Maintenance, troubleshooting, spare parts and dismantling

12.1 Checks and maintenance



Certified skilled personnel

Installation works must exclusively be carried out by authorised and qualified skilled personnel. Prior to undertaking any measures on the DRYPOINT® RAX 200-500 NA compressed-air refrigeration dryer, the certified skilled personnel⁴ shall read up on the device by carefully studying the operating instructions. The operator is responsible for the adherence to these provisions. The respective directives in force apply to the qualification and expertise of the certified skilled personnel.

For safe operation, the device must only be installed and operated in accordance with the indications in the operating instructions. In addition, the national and operational statutory provisions and safety regulations, as well as the accident prevention regulations required for the respective case of application, need to be observed during employment. This applies accordingly when accessories are used.



Danger!

Compressed air!

Risk of serious injury or death through contact with quickly or suddenly escaping compressed air or through bursting and/or unsecured plant components.

⁴ Certified skilled personnel are persons who are authorised by the manufacturer, with experience and technical training, who are well-grounded in the respective provisions and laws and capable of carrying out the required works and of identifying and avoiding any risks during the machine transport, installation, operation and maintenance. Qualified and authorised operators are persons who are instructed by the manufacturer regarding the handling of the refrigeration system, with experience and technical training, and who are well-grounded in the respective provisions and laws.

Compressed air is a highly dangerous energy source.

Never work on the dryer when the system is under pressure.

Never direct the compressed-air outlet or condensate drain hoses at persons.

The user is responsible for the proper maintenance of the dryer. Non-observance of the instructions in the "Installation" and "Maintenance, troubleshooting, spare parts and dismantling" chapters leads to the expiration of the guarantee. Improper maintenance may result in dangerous situations for the personnel and/or the device.



Danger!

Supply voltage!

Contact with non-insulated parts carrying supply voltage involves the risk of an electric shock resulting in injuries and death.

Only qualified and skilled personnel are authorised to run electrically-operated devices. Prior to undertaking maintenance measures at the device, the following requirements must be met:

Make sure that the power supply is switched off and that the device is off and marked for maintenance measures. Please also ensure that the power supply cannot be re-established during the works.



Prior to carrying out maintenance works at the dryer, switch it off and wait for at least 30 minutes.



Caution!

Hot surfaces!

During operation, several components can reach surface temperatures of more than 140°F (60°C). There is the risk of burns.

All components concerned are installed inside of the closed housing. The housing must only be opened by certified skilled personnel.

Some components can reach high temperatures during operation. Avoid any contact until the system or the component has cooled down.



DAILY:

- Check whether the dew point indicated on the electronics is correct.
- Ensure that the condensate drain system functions properly.
- Make sure that the condenser is clean.

EVERY 200 HOURS OR MONTHLY



- Clean the condenser using an air jet (max. 2 bar / 30 psig) inside out. Make sure not to damage the aluminium lamellae of the cooling package.
- Finally, verify the operation of the device.

EVERY 1,000 HOURS OR ANNUALLY



- Verify all screws, clamps and connections of the electric system to make sure that they are fastened securely. Check the device for broken and ruptured cables or cables without insulation.
- Check the refrigeration cycle for signs of oil and refrigerant leaks.
- Measure the current strength and note it down. Ensure that the read values are within the permissible limit values, as indicated in the specification table.
- Check the hose lines of the condensate drain and replace them, if required.
- Finally, verify the operation of the device.



EVERY 8,000 HOURS

- Replace BEKOMAT Service Unit.

12.2 Troubleshooting



Certified skilled personnel

Installation works must exclusively be carried out by authorised and qualified skilled personnel. Prior to undertaking any measures on the DRYPOINT® RAX 200-500 NA compressed-air refrigeration dryer, the certified skilled personnel shall read up on the device by carefully studying the operating instructions. The operator is responsible for the adherence to these provisions. The respective directives in force apply to the qualification and expertise of the certified skilled personnel.

For safe operation, the device must only be installed and operated in accordance with the indications in the operating instructions. In addition, the national and operational statutory provisions and safety regulations, as well as the accident prevention regulations required for the respective case of application, need to be observed during employment. This applies accordingly when accessories are used.



Danger!

Compressed air!

Risk of serious injury or death through contact with quickly or suddenly escaping compressed air or through bursting and/or unsecured plant components.

Compressed air is a highly dangerous energy source.

Never work on the dryer when the system is under pressure.

Never direct the compressed-air outlet or condensate drain hoses at persons.

The user is responsible for the proper maintenance of the dryer. Non-observance of the instructions in the "Installation" and "Maintenance, troubleshooting, spare parts and dismantling" chapters leads to the expiration of the guarantee. Improper maintenance may result in dangerous situations for the personnel and/or the device.



Danger!

Supply voltage!

Contact with non-insulated parts carrying supply voltage involves the risk of an electric shock resulting in injuries and death.

Only qualified and skilled personnel are authorised to run electrically-operated devices. Prior to undertaking maintenance measures at the device, the following requirements must be met:

Make sure that the power supply is switched off and that the device is off and marked for maintenance measures. Please also ensure that the power supply cannot be re-established during the works.



Prior to carrying out maintenance works at the dryer, switch it off and wait for at least 30 minutes.



Caution!
Hot surfaces!



During operation, several components can reach surface temperatures of more than 140°F (60°C). There is the risk of burns.

All components concerned are installed inside of the closed housing. The housing must only be opened by certified skilled personnel.

Some components can reach high temperatures during operation. Avoid any contact until the system or the component has cooled down.

FAULT	POSSIBLE REASON – SUGGESTED MEASURE
◆ The dryer does not start.	<ul style="list-style-type: none"> ⇒ Check whether or not the dryer is connected with the electric mains. ⇒ Check the electric cabling. ⇒ Blow of fuse (FU3 on the electric diagram) of the auxiliary circuit - replace it and check the proper operation of the dryer.
◆ The refrigerating compressor does not work.	<ul style="list-style-type: none"> ⇒ The internal heat protection of the compressor was activated – wait 30 minutes and then retry. ⇒ Check the electric cabling. ⇒ If installed – replace the internal heat protection and/or the start-up relay and/or the starting capacitor and/or the operating capacitor. ⇒ If installed – the HPS pressure switch was activated – see the corresponding point. ⇒ If installed – the LPS pressure switch was activated – see the corresponding point. ⇒ If installed – the TS safety temperature switch was activated – see the corresponding point. ⇒ In the event that the compressor still does not work, replace it.
◆ The fan of the condenser does not work (air-cooled).	<ul style="list-style-type: none"> ⇒ Check the electric cabling. ⇒ The PV pressure switch is defective. Contact a service technician. ⇒ Blow of fuse (FU1-FU2 on the electric diagram) - replace it and check the proper operation of the dryer. ⇒ There is a leak in the refrigeration cycle – contact a service technician. ⇒ In the event that the fan still does not work, replace it.
◆ Dew point too high.	<ul style="list-style-type: none"> ⇒ The dryer does not start up – see the corresponding point. ⇒ The T1 dew point sensor does not record the temperature properly – ensure that the sensor is pushed down to the bottom of the aluminium tube immersion sleeve. ⇒ The refrigerating compressor does not work – see the corresponding point. ⇒ The ambient temperature is too high or the room ventilation insufficient – ensure sufficient ventilation (air-cooled). ⇒ The inlet air is too hot – re-establish the nominal conditions. ⇒ The inlet air pressure is too low – re-establish the nominal conditions. ⇒ The inlet air throughput is higher than the throughput of the dryer – reduce the flow rate - re-establish the nominal conditions. ⇒ The condenser is dirty – please clean it (air-cooled). ⇒ The condenser fan does not work – see the corresponding point (air-cooled). ⇒ The cooling-water flow is insufficient – re-establish the nominal conditions (water-cooled). ⇒ The dryer does not discharge the condensate – see the corresponding point. ⇒ The hot-gas bypass valve needs to be re-adjusted – contact a service technician to have the nominal setting re-established. ⇒ There is a leak in the refrigeration cycle – contact a service technician.
◆ Dew point too low.	<ul style="list-style-type: none"> ⇒ The fan runs continuously – the PV pressure switch is defective – replace it (air-cooled). ⇒ The ambient temperature is too low –re-establish the nominal conditions. ⇒ The hot-gas bypass valve needs to be re-adjusted – contact a service technician to have the nominal setting re-established.

Maintenance, troubleshooting, spare parts and dismantling

◆ Extreme pressure drop in the dryer.	<ul style="list-style-type: none"> ⇒ The dryer does not discharge the condensate – see the corresponding point. ⇒ The dew point is too low – the condensate is frozen and blocks the air – see the corresponding point. ⇒ Check the flexible connection hoses for obstructions.
◆ The dryer does not drain the condensate.	<ul style="list-style-type: none"> ⇒ The shut-off valve at the condensate outlet is closed – open it. ⇒ Check the electric cabling. ⇒ The dew point is too low – the condensate is frozen – see the corresponding point. ⇒ The BEKOMAT condensate drain does not work properly (see BEKOMAT MANUAL).
◆ Failure during the condensate discharge.	<ul style="list-style-type: none"> ⇒ Please read the separate BEKOMAT installation and operating instructions.
◆ Water in the line.	<ul style="list-style-type: none"> ⇒ The dryer does not start – see the corresponding point. ⇒ If installed - untreated air flows through the bypass unit – close the bypass. ⇒ The dryer does not drain condensate – see the corresponding point. ⇒ Dew point too high – see the corresponding point.
◆ If installed: the HPS high-pressure switch has triggered.	<ul style="list-style-type: none"> ⇒ Check which of the following reasons is responsible for the triggering: <ol style="list-style-type: none"> 1. The ambient temperature is too high or the room ventilation insufficient – ensure sufficient ventilation (air-cooled). 2. The condenser is dirty – please clean it (air-cooled). 3. The condenser fan does not work – see the corresponding point (air-cooled). 4. The cooling water is too hot – re-establish the nominal conditions (water-cooled). 5. The cooling-water flow is insufficient – re-establish the nominal conditions (water-cooled). ⇒ Reset the pressure switch by pressing the button on the controller itself – check the proper functioning of the dryer. ⇒ The HPS pressure switch is defective – contact a service technician for the replacement.
◆ If installed: the LPS low-pressure switch was triggered.	<ul style="list-style-type: none"> ⇒ There is a leak in the refrigeration cycle – please contact a service technician. ⇒ The pressure switch is automatically reset as soon as the normal conditions are re-established – check the dryer for proper functioning.
◆ If installed: the T _S safety temperature switch was triggered.	<ul style="list-style-type: none"> ⇒ Check which of the following reasons is responsible for the triggering: <ul style="list-style-type: none"> Excess thermal load – re-establish the standard operating conditions. The inlet air is too hot – re-establish the nominal conditions. The ambient temperature is too high or the room ventilation insufficient – ensure sufficient ventilation. The condenser unit is dirty – please clean it. The fan does not work – see the corresponding point. The hot-gas bypass valve needs to be re-adjusted – contact a specialist for refrigerating plants to have the nominal calibration re-established. The cooling-water temperature is too low – re-establish the nominal conditions (water-cooled). The adjusting valve for the cooling-water flow needs to be re-adjusted – contact a specialist to have the nominal calibration re-established (water-cooled). There is a leak in the refrigeration cycle – please contact a service technician. ⇒ Reset the temperature switch by manually pushing the button on the temperature switch – check the perfect functioning of the dryer. ⇒ The TS temperature switch is defective – replace it.
◆ The DMC18  LED is on.	<ul style="list-style-type: none"> ⇒ When the  LED flashes: one or more service warnings/alarms are active. The display shows the dew point temperature and the active service warnings/alarms. ⇒ The service warnings are indicated by the following messages: <ol style="list-style-type: none"> 1. PF : PF – Failure temperature probe T1 (dew point) – check the electric cabling and/or replace the probe. 2. HdP : HdP – Dew point too high (higher than the adjusted alarm value) – see the corresponding section. 3. LdP : Ldp – Dew point too low (lower than the adjusted alarm value) – see the corresponding section. 4. drA : drA – The Bekomat BM-IF condensate drain does not work properly - see the corresponding section. 5. SrV : SrV - Service – maintenance notification time expired (parameter SrV) – carry out the scheduled maintenance and reset the hour meter. NOTE: SrV Service (service time expired) needs to be reset manually (press the  button and keep it pressed for at least 20 seconds).

12.3 Recommended spare parts

Spare parts list is printed on a dedicated sticker applied inside the dryer. On this sticker each spare part is identified with its ID Number and related Spare Part Number. Here below the cross-reference table between ID Numbers and exploded drawings Ref. with their description and quantity installed in the dryers.

NOTE: To order the recommended spare parts or other elements, the data on the name plate must be indicated.

ID N.		DESCRIPTION	DP RAX NA					
			200	250	300	350	400	500
1		Complete heat exchanger	1	1	1	1	1	1
2	LPS	Pressure switch	1	1	1	1	1	1
3	TS	Safety thermo switch	1	1	1	1	1	1
4	HPS	Pressure switch	1	1	1	1	1	1
5	PV	Pressure switch	1	1	1	1	1	1
6	MC	Compressor	1	1	1	1	1	1
7		Hot gas by-pass valve	1	1	1	1	1	1
8		Condenser	1	1	1	1	1	1
9	MV	Complete fan	1	1	1	1	1	1
10		Filter drier	1	1	1	1	1	1
12	BT	Temperature probe	1	1	1	1	1	1
17	DMC18	Electronic instrument	1	1	1	1	1	1
19		Water regulating valve (water cooled)	1	1	1	1	1	1
21	ELD	BEKOMAT condensate drain	1	1	1	1	1	1
		BEKOMAT service unit	1	1	1	1	1	1
22	S1	Lighted switch	1	1	1	1	1	1
	QS	Main switch	1	1	1	1	1	1
60	FU	Fuse kit	1	1	1	1	1	1
	KC1-KV1	Contactor	2	2	2	2	2	2
	TF	Transformer	1	1	1	1	1	1

12.4 Maintenance works at the refrigeration cycle



Caution! Refrigerant!

Maintenance and repair works at refrigeration systems must only be carried out by service technicians in accordance with the local provisions.

The total amount of refrigerant in the system must be collected for recycling purposes, resource recovery or disposal.

The refrigerant must not be discharged into the environment.

When delivered, the dryer is ready to operate and filled with a refrigerant of the R134a or R407C type.



Should you detect a refrigerant leak, please contact a service technician. Prior to any intervention, the room needs to be ventilated.

When the refrigeration cycle needs to be refilled, please also contact a service technician.

You will find the refrigerant type and amount on the name plate of the dryer.

Properties of the refrigerants used:

Refrigerant	Chemical formula	MIK	GWP
R134a - HFC	CH ₂ FCF ₃	1000 ppm	1430
R407C - HFC	R32/125/134a (23/25/52) CHF ₂ CF ₃ /CH ₂ F ₂ /CH ₂ FCF ₃	1000 ppm	1773,85

12.5 Dismantling the dryer

When the dryer is dismantled, all parts and operating materials related to the plant need to be disposed of separately.



Component	Material
Refrigerant	R407C, R134a, oil
Roof and supports	Structural steel, epoxy paint coat
Refrigerating compressor	Steel, copper, aluminium, oil
Aluminium heat exchanger	Aluminium
Condenser unit	Aluminium, copper, structural steel
Pipe	Copper
Fan	Aluminium, copper, steel
Valve	Brass, steel
BEKOMAT condensate drain	PVC, aluminium, steel
Insulant	Synthetic rubber without CFCs, polystyrene, polyurethane
Electric cable	Copper, PVC
Electric parts	PVC, copper, brass



We recommend observing the safety provisions in force for the disposal of each material type.

The refrigerant contains lubricating-oil droplets which are released by the compressor.

The refrigerant must not be discharged into the environment. It must be sucked off from the dryer using a suitable device, and then needs to be supplied to a collection point.

13.1.2 Dryer dimensions DRYPOINT RAX 300-350 NA 3phase

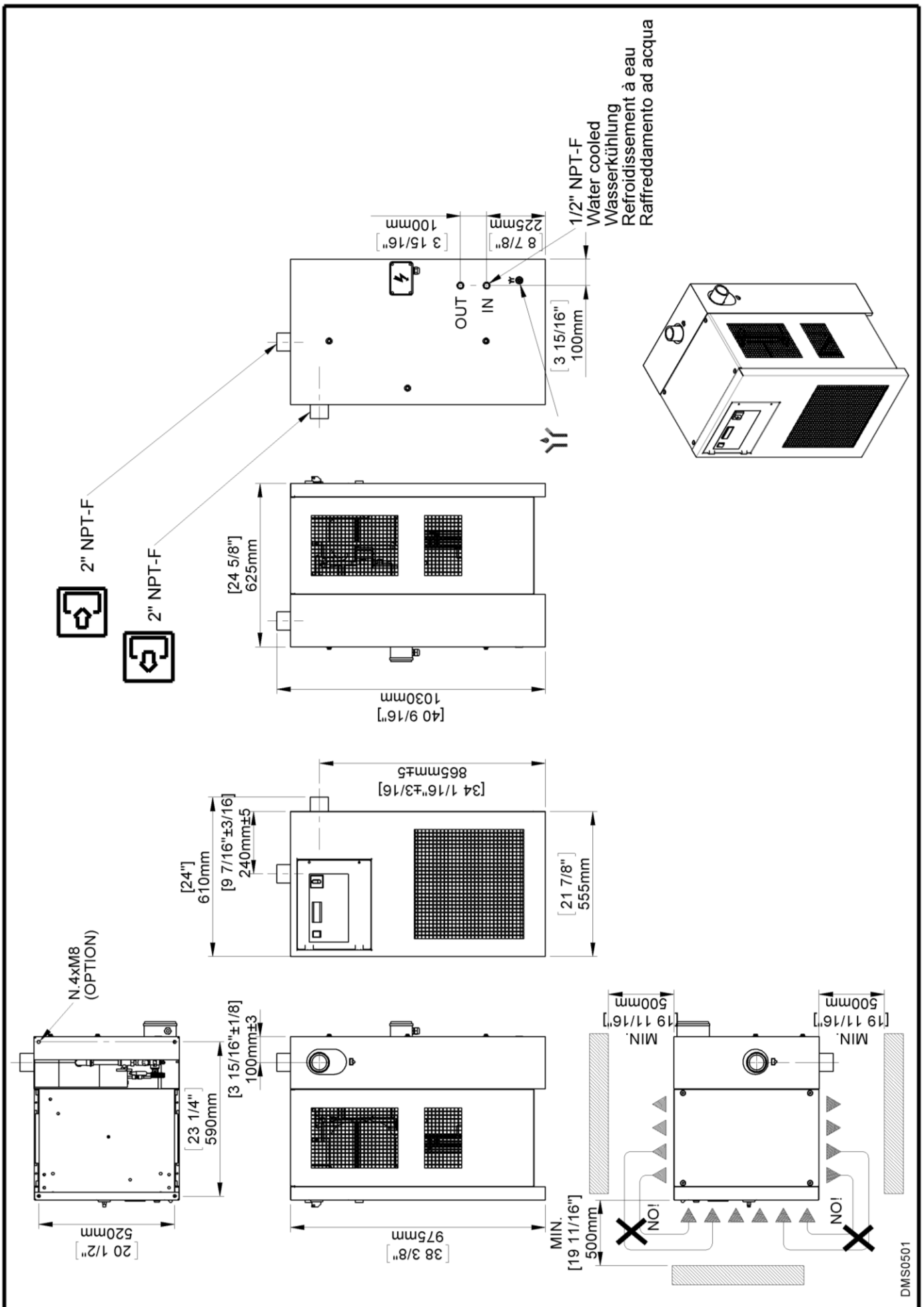

13.1.3 Dryer dimensions DRYPOINT RAX 400-500 NA 3phase

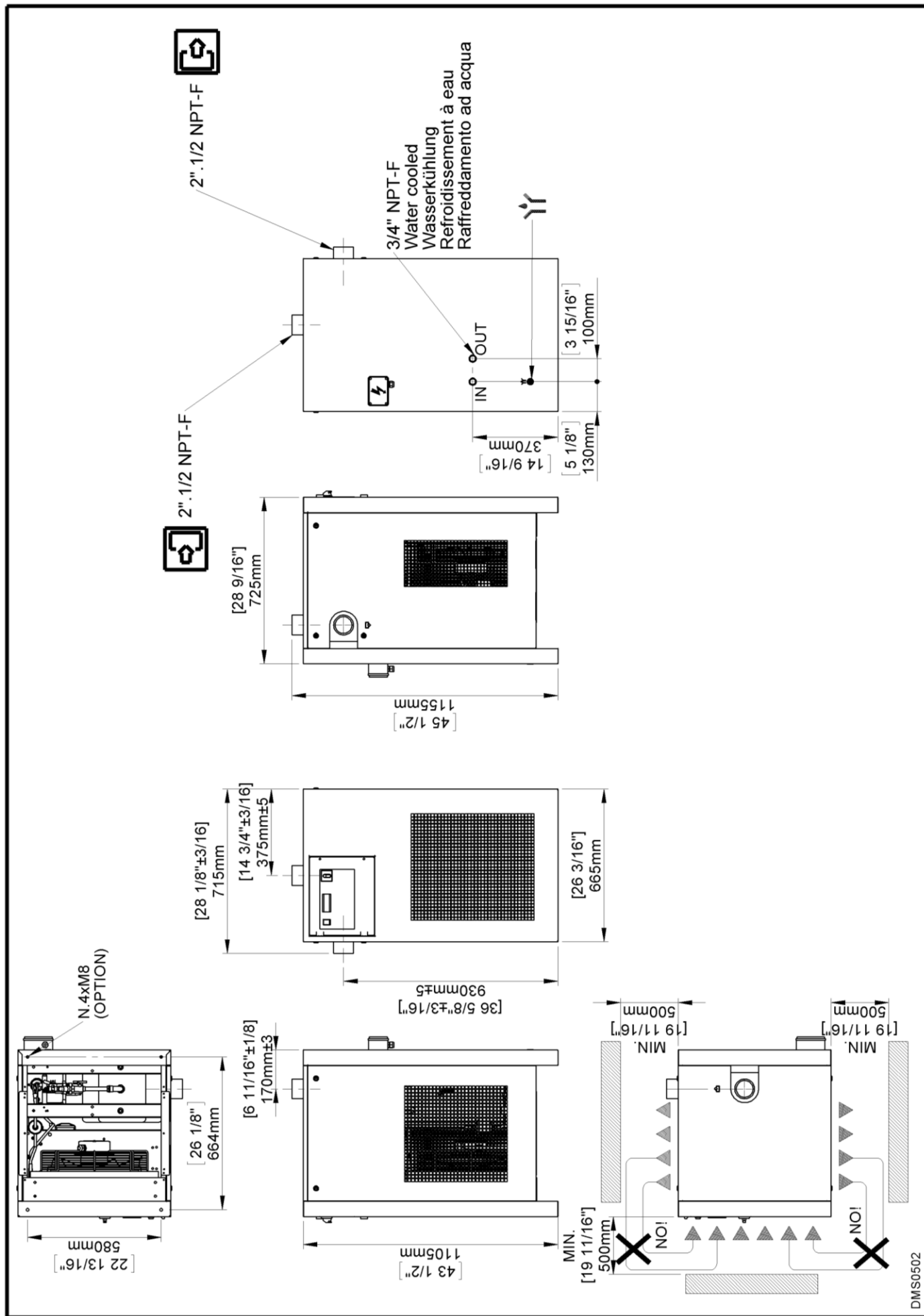

13.2 Exploded diagrams**13.2.1 Components of the exploded diagrams**

1	Alu drying module	20	Refrigerant reservoir (water-cooled)
	1.1 Insulation material	21	Bekomat drain
2	Refrigerant pressure switch LPS	22	Main switch
3	Safety temperature switch TS	...	
4	Refrigerant pressure switch HPS	51	Front panel
5	Refrigerant fan pressure switch PV	52	Back plate
6	Compressor	53	Right sidewall
7	Hot-gas bypass valve	54	Left sidewall
8	Condenser (air-cooled)	55	Cover
9	Condenser fan	56	Base plate
	9.1 Motor	57	Upper plate
	9.2 Blade	58	Carrier support
	9.3 Grid	59	Support bracket
10	Filter dryer	60	Control panel
11	Capillary tube	61	Electric connecting plug
12	T1 temperature probe (dew point)	62	Electric cabinet
13	Condensate drain service valve	65	Condenser filter
17	Air dryer control	66	QE door
18	Condenser (water-cooled)	81	Adhesive label flow chart
19	Condenser water-regulating valve (water-cooled)	100	Autotransformer

13.2.3 Exploded diagram DRYPOINT RAX 300-350 NA 3phase / AC

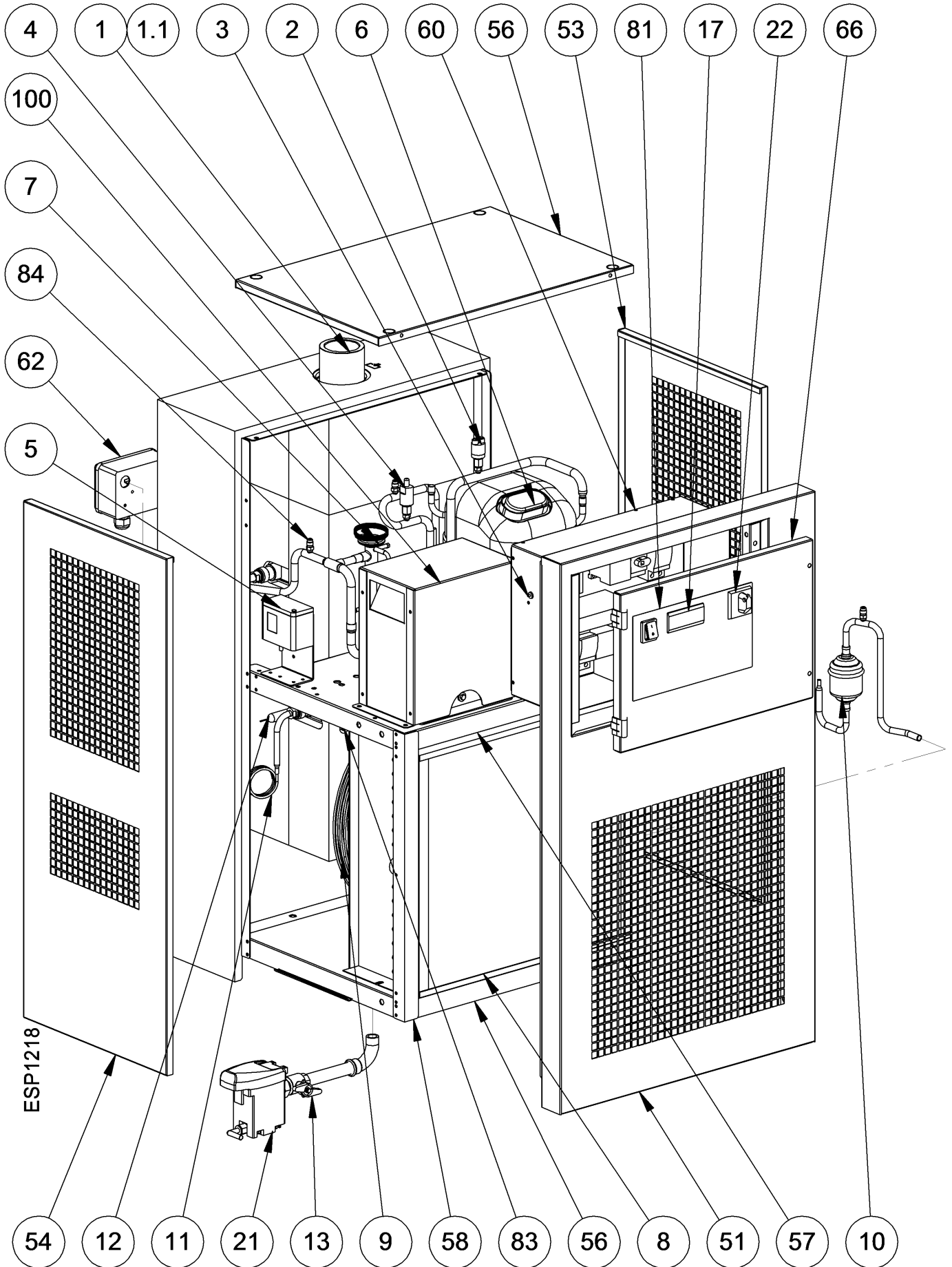

13.2.4 Exploded diagram DRYPOINT RAX 400-500 NA 3phase / AC

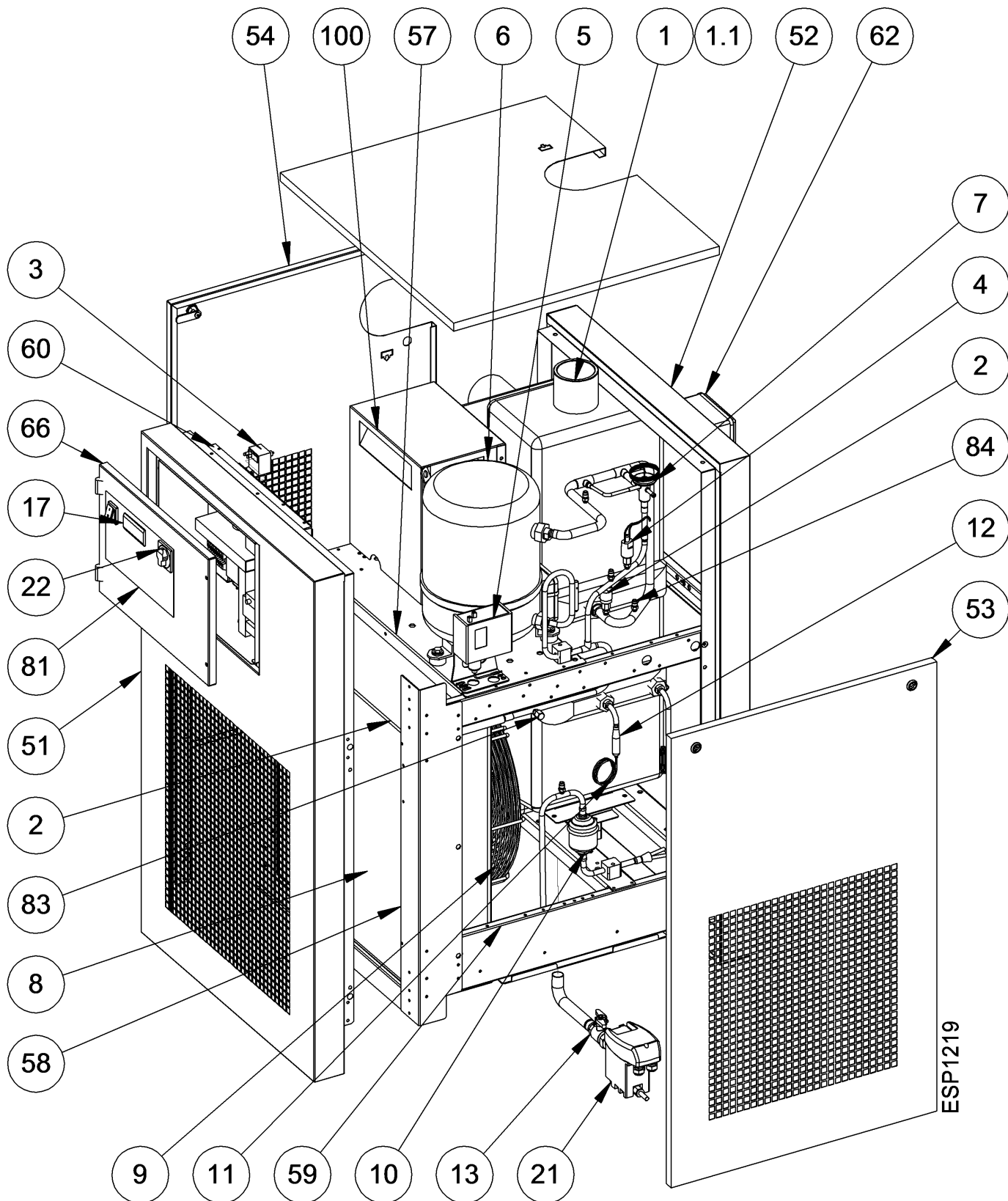

13.2.5 Exploded diagram DRYPOINT RAX 200-250 NA 3phase / WC

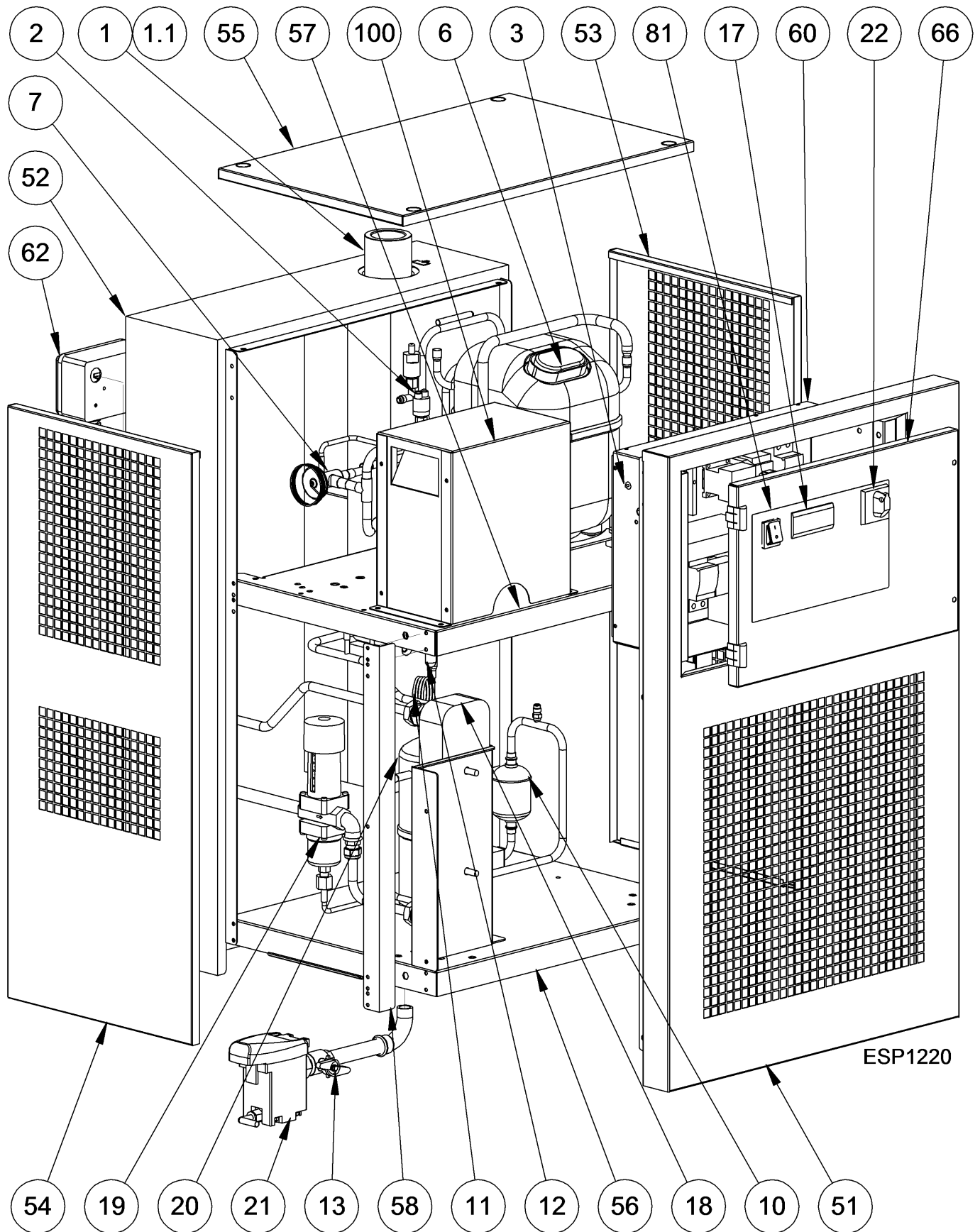

13.2.6 Exploded diagram DRYPOINT RAX 300-350 NA 3phase / WC

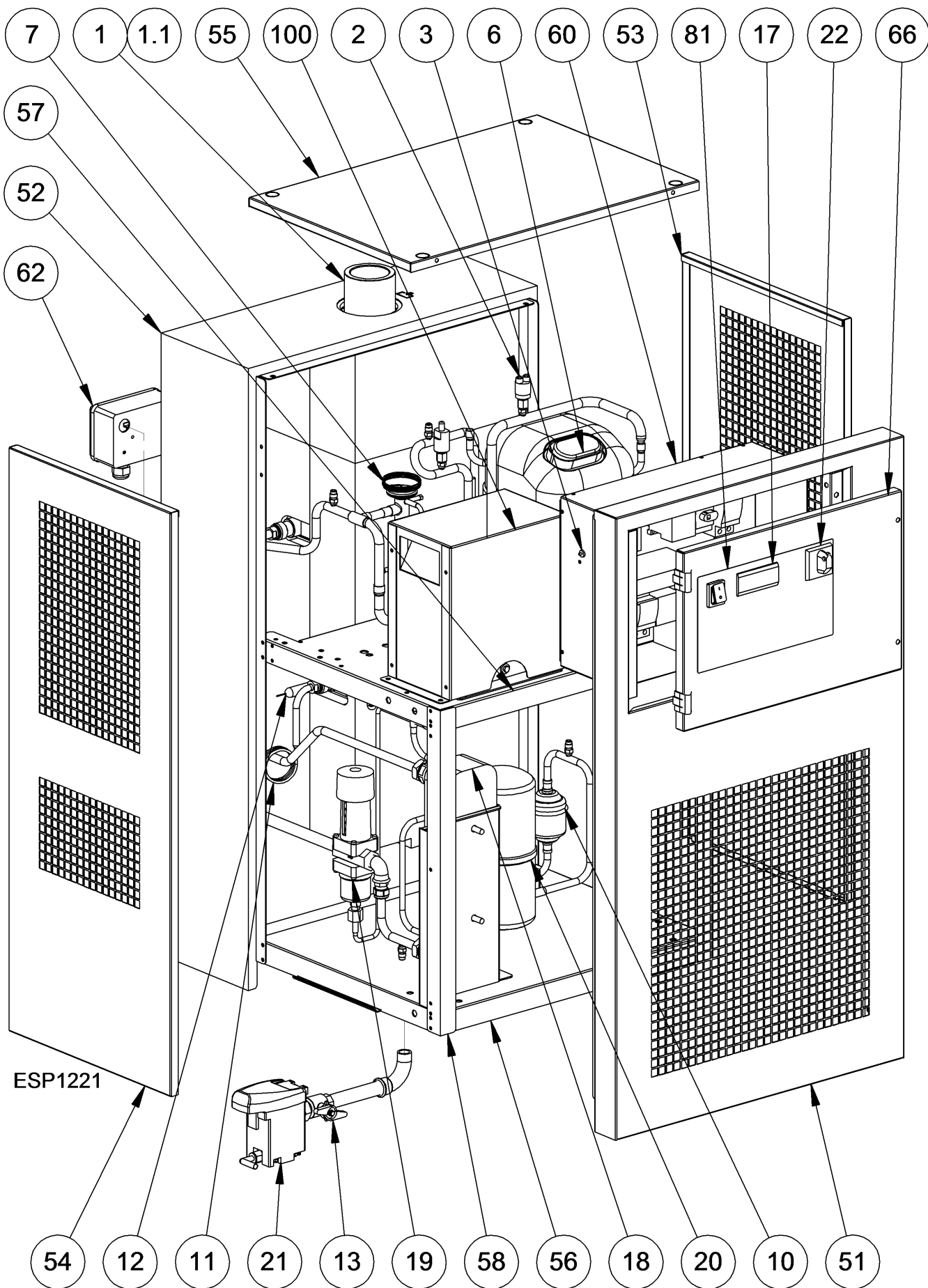

13.2.7 Exploded diagram DRYPOINT RAX 400-500 NA 3phase / WC

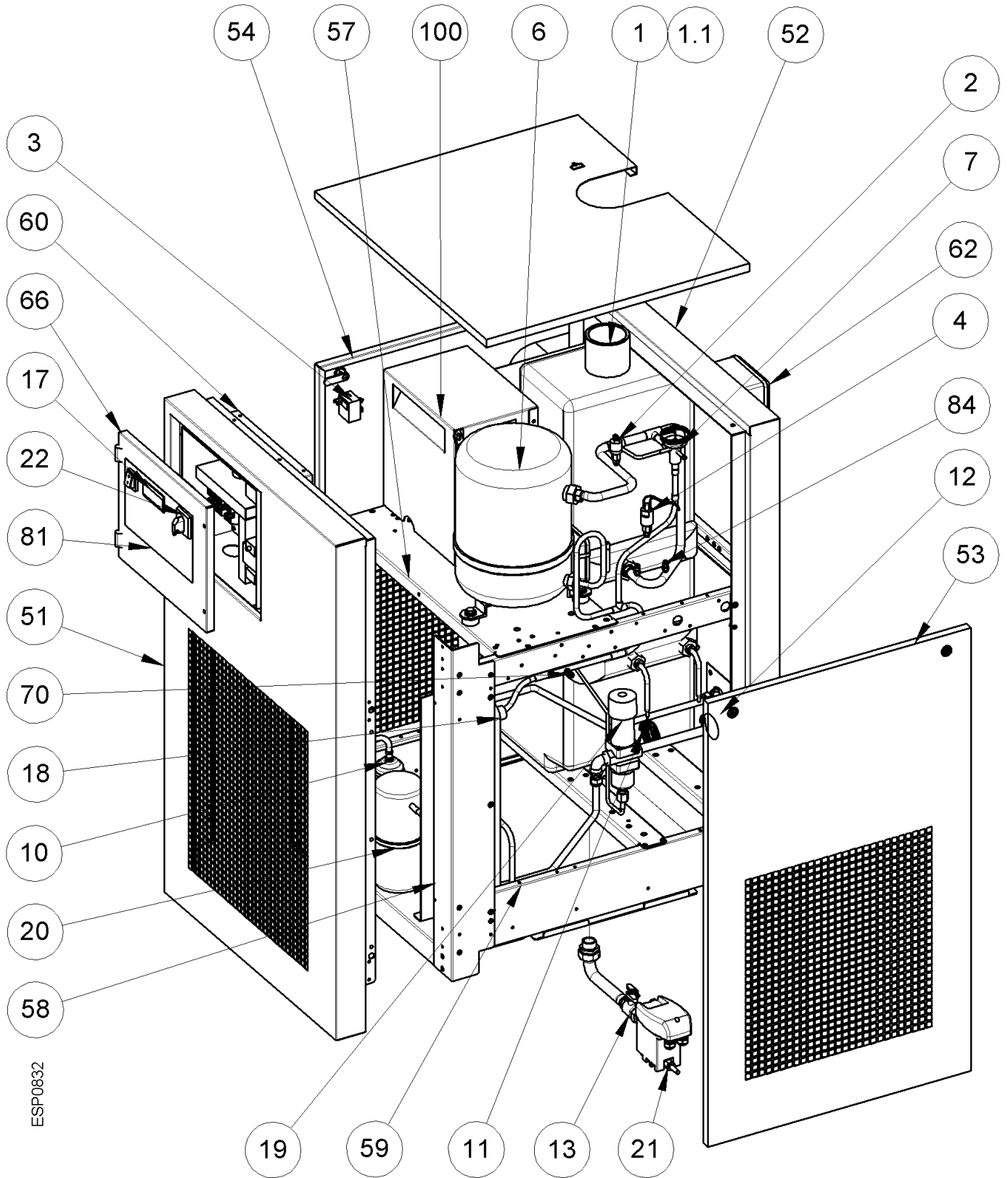

ESP0832

13.3 Electric diagrams

13.3.1 Electric diagrams – list of components

- MC** : Compressor
 - KT** : Compressor thermal protection
 - KR** : Compressor starting relay (if installed)
 - CS** : Compressor starting capacitor (if installed)
 - CR** : Compressor operating capacitor (if installed)
- MV** : Condenser fan
 - CV** : Fan starting capacitor (if installed)
- DMC18** : DMC18 electronic control unit
 - BT1** : T1 Temperature probe – dew point
- HPS** : Pressure switch – compressor discharge side (HIGH PRESSURE)
- LPS** : Pressure switch – compressor suction side (LOW PRESSURE)
- PV** : Pressure switch – fan control
- TS** : Safety temperature switch
- ELD** : BEKOMAT drain
- S1** : ON/OFF switch
- QS** : Main switch with locking device
- RC** : Compressor crankcase heater
- TR** : Autotransformer
- BOX** : Electrical connection

- NT1** : Only air-cooled
- NT2** : Check the transformer connections with regard to the supply voltage
- NT3** : Jump, if not installed
- NT4** : Provided and cabled by the customer
- NT5** : Internal control
- NT6** : Time-controlled drain outlet (not used)
- NT7** : Only water-cooled

- BN** = BROWN **OR** = ORANGE
- BU** = BLUE **RD** = RED
- BK** = BLACK **WH** = WHITE
- YG** = YELLOW/GREEN **WH/BK** = WHITE/BLACK

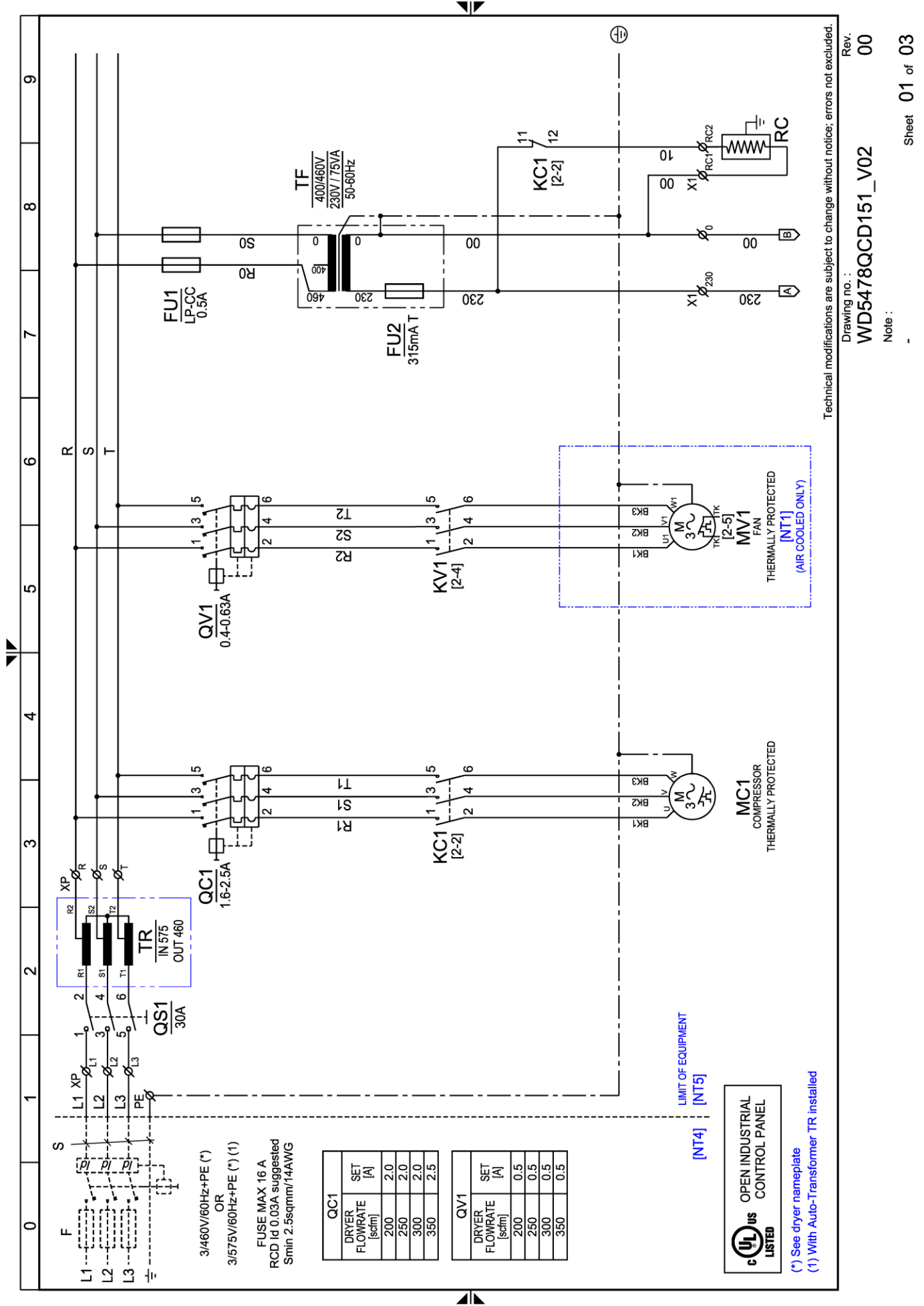

3/460V/60Hz+PE (*)
OR
3/575V/60Hz+PE (*) (1)

FUSE MAX 16 A
RCD Id 0.03A suggested
Smin 2.5sqmm/14AWG

QC1	
DRYER FLOWRATE [scfm]	SET [A]
200	2.0
250	2.0
300	2.0
350	2.5

QV1	
DRYER FLOWRATE [scfm]	SET [A]
200	0.5
250	0.5
300	0.5
350	0.5

UL LISTED
OPEN INDUSTRIAL CONTROL PANEL

(*) See dryer nameplate
(1) With Auto-Transformer TR installed

Technical modifications are subject to change without notice; errors not excluded.

Rev.

00

WD5478QCD151_V02

Note :

Sheet 01 of 03

13.3.4 Electric diagram DRYPOINT RAX 200-350 NA 3phase Sheet 3/3

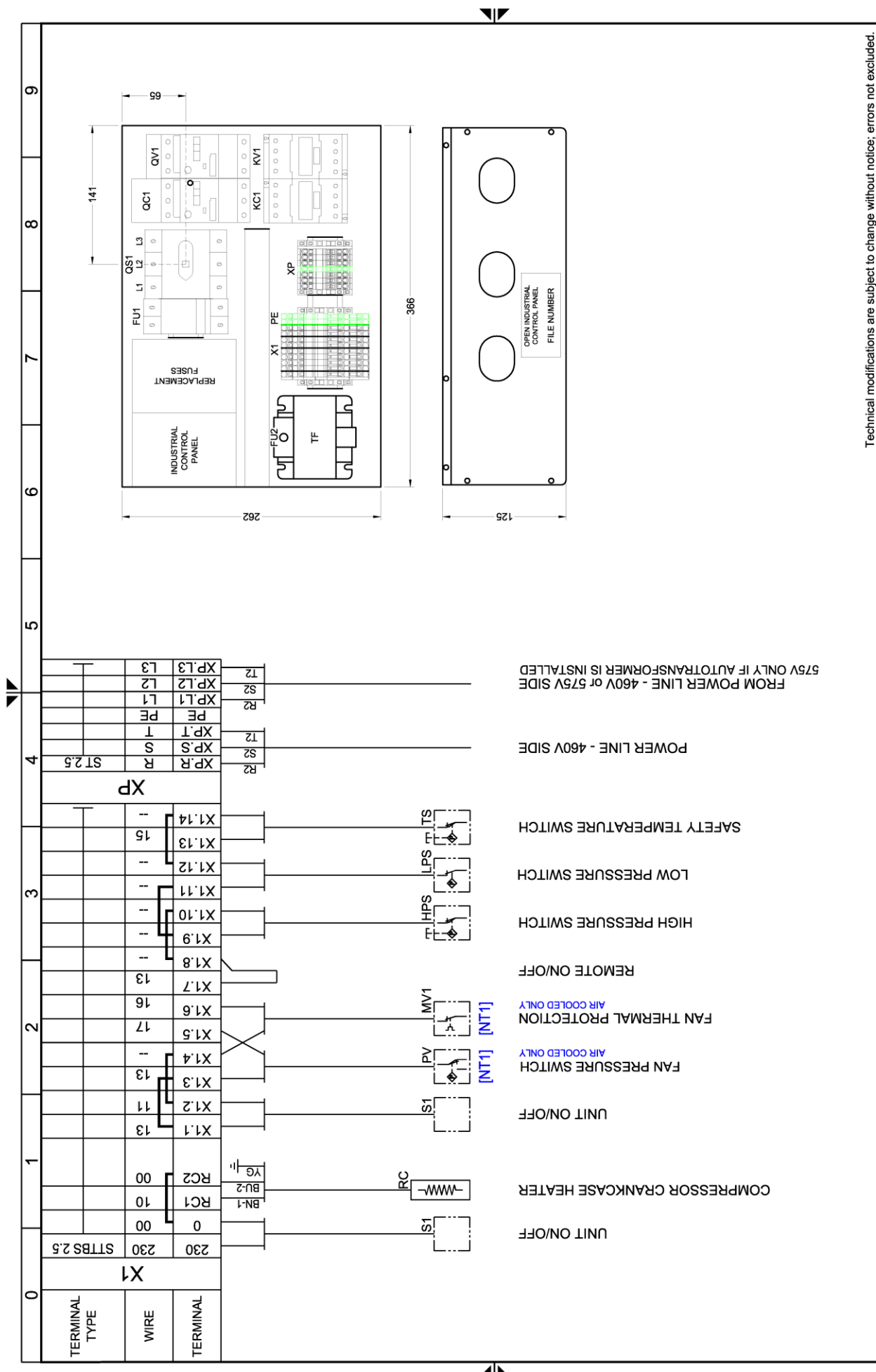

Technical modifications are subject to change without notice; errors not excluded.

Drawing no.: **WD5478QCD151_V02**
 Rev. **00**
 Note: -
 Sheet **03** of **03**

13.3.5 Electric diagram DRYPOINT RAX 400-500 NA 3phase Sheet 1/3

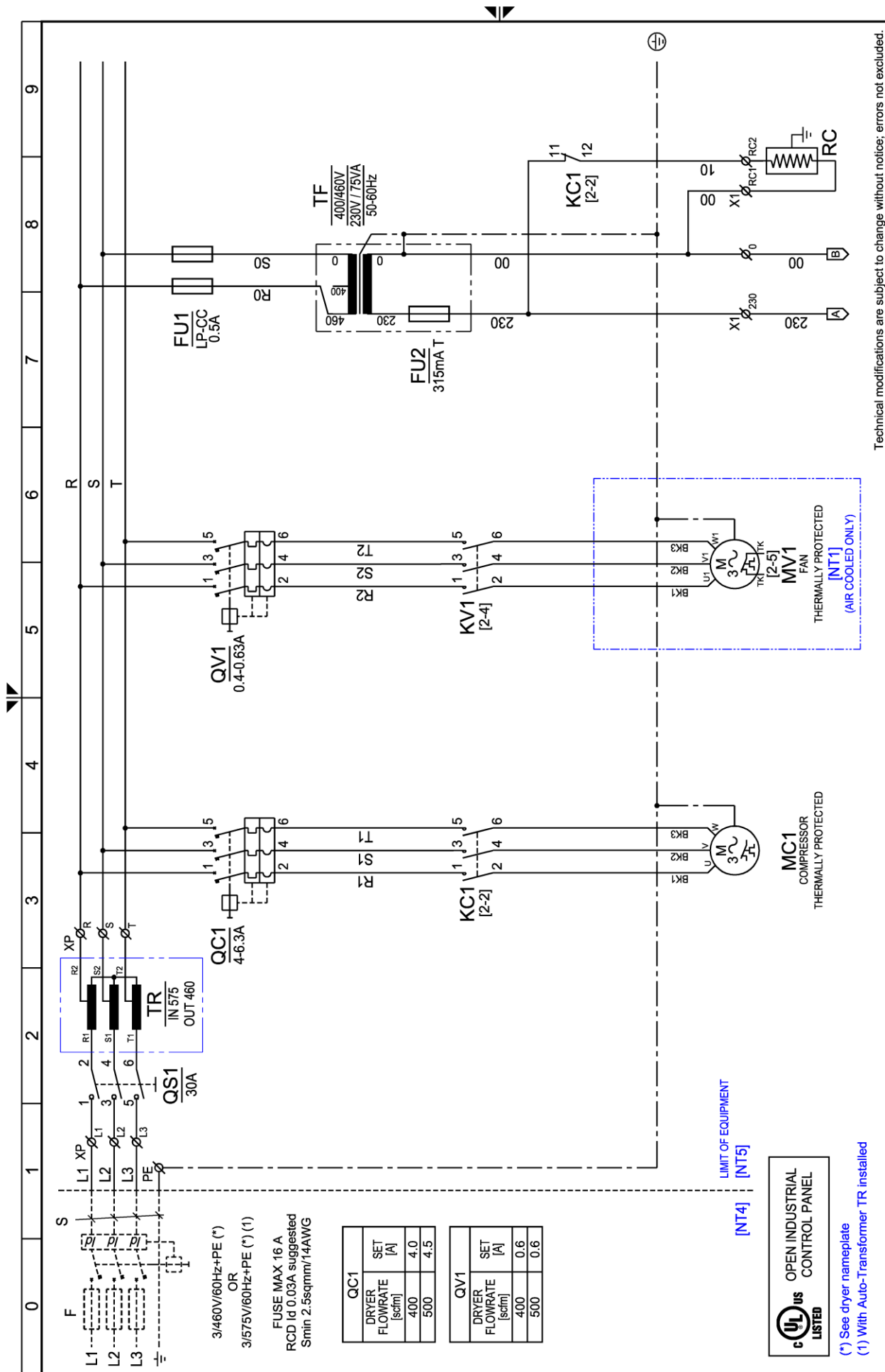

3/460V/60Hz+PE (*)
OR
3/575V/60Hz+PE (*) (1)

FUSE MAX 16 A
RCD Id 0.03A suggested
Smin 2.5sqmm/14AWG

QC1		QV1	
DRYER FLOWRATE [scfm]	SET [A]	DRYER FLOWRATE [scfm]	SET [A]
400	4.0	400	0.6
500	4.5	500	0.6



(*) See dryer nameplate
(1) With Auto-Transformer TR installed

Technical modifications are subject to change without notice; errors not excluded.

Drawing no. : **WD5478QCD152_V02**

Rev. **00**
Note :

Sheet **01** of **03**

13.3.7 Electric diagram DRYPOINT RAX 400-500 NA 3phase Sheet 3/3

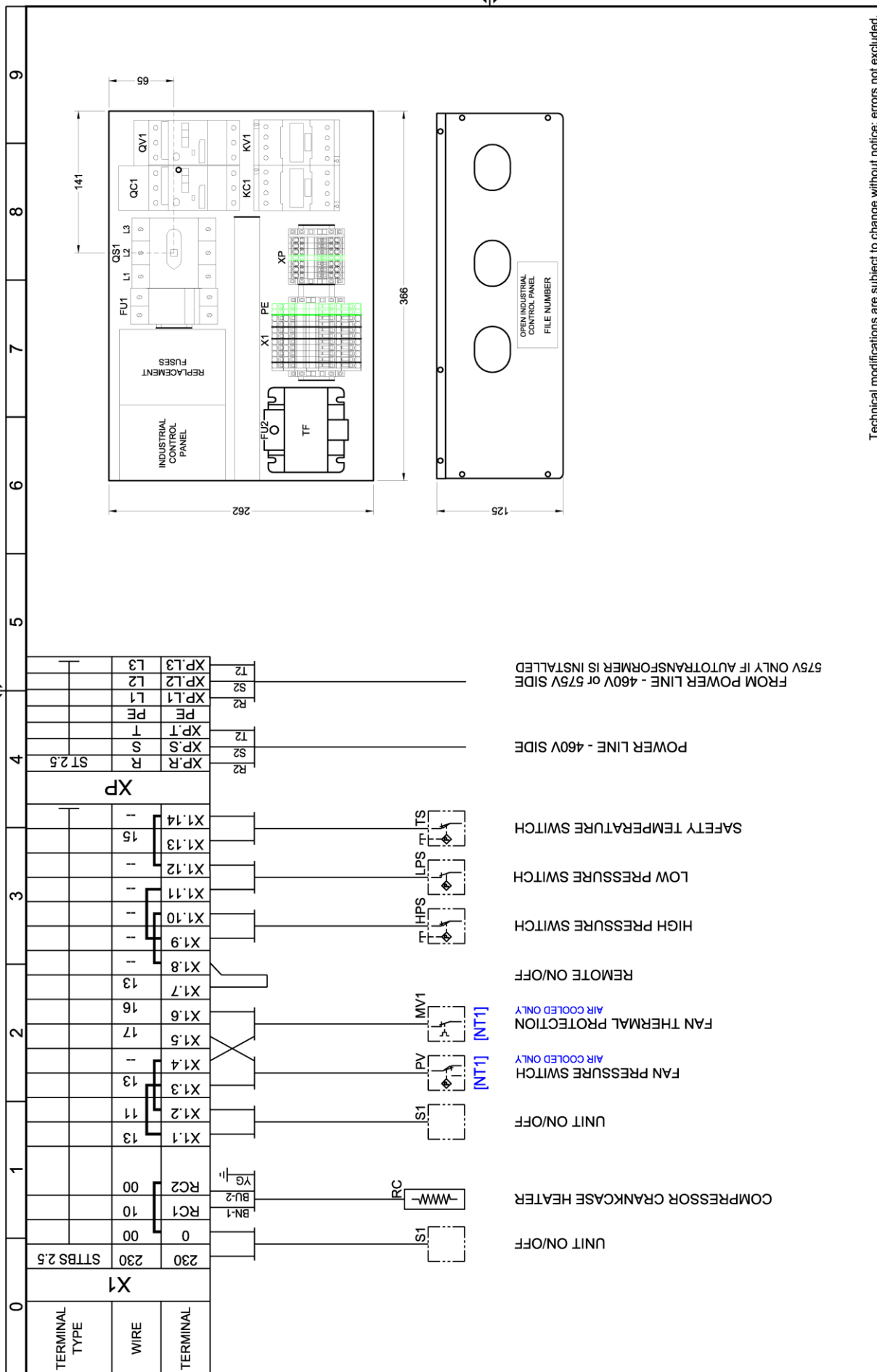

Technical modifications are subject to change without notice; errors not excluded.

Drawing no. : WD5478QCD152_V02

Rev. : 00

Note : -

Sheet 03 of 03

<p>Headquarter Deutschland / Germany BEKO TECHNOLOGIES GMBH Im Taubental 7 D - 41468 Neuss Tel. +49 2131 988 0 Mobil +49 / (0) 174 / 376 03 13 info@beko-technologies.com</p>	<p>United Kingdom BEKO TECHNOLOGIES LTD. Unit 11-12 Moons Park Burnt Meadow Road North Moons Moat Redditch, Worcs, B98 9PA Tel. +44 1527 575 778 info@beko-technologies.co.uk</p>	<p>France BEKO TECHNOLOGIES S.à.r.l. Zone Industrielle 1 Rue des Frères Rémy F - 57200 Sarreguemines Tél. +33 387 283 800 info@beko-technologies.fr</p>
<p>Benelux BEKO TECHNOLOGIES B.V. Veenen 12 NL - 4703 RB Roosendaal Tel. +31 165 320 300 benelux@beko-technologies.com</p>	<p>中华人民共和国 / China BEKO TECHNOLOGIES (Shanghai) Co. Ltd. Rm. 606 Tomson Commercial Building 710 Dongfang Rd. Pudong Shanghai China P.C. 200122 Tel. +86 21 508 158 85 info.cn@beko-technologies.cn</p>	<p>Česká Republika / Czech Republic BEKO TECHNOLOGIES s.r.o. Na Pankraci 58 CZ - 140 00 Praha 4 Tel. +420 24 14 14 717 / +420 24 14 09 333 Mobil +420 605 274 743 info@beko-technologies.cz</p>
<p>España / Spain BEKO Tecnológica España S.L. Torruella i Urpina 37-42, nave 6 E - 08758 Cervelló Tel. +34 93 632 76 68 Mobil +34 610 780 639 info.es@beko-technologies.es</p>	<p>中華人民共和國香港特別行政區 / Hong Kong SAR of China BEKO TECHNOLOGIES LIMITED Unit 1010 Miramar Tower 132 Nathan Rd. Tsim Sha Tsui Kowloon Hong Kong Tel. +852 5578 6681 (Hong Kong) Tel. +86 147 1537 0081 (China) tim.chan@beko-technologies.com</p>	<p>India BEKO COMPRESSED AIR TECHNOLOGIES Pvt. Ltd. Plot No.43/1 CIEEP Gandhi Nagar Balanagar Hyderabad IN - 500 037 Tel +91 40 23080275 / +91 40 23081107 madhusudan.masur@bekoindia.com</p>
<p>Italia / Italy BEKO TECHNOLOGIES S.r.l Via Peano 86/88 I - 10040 Leini (TO) Tel. +39 011 4500 576 Fax +39 0114 500 578 info.it@beko-technologies.com</p>	<p>日本 / Japan BEKO TECHNOLOGIES K.K KEIHIN THINK Building 8 Floor 1-1 Minamiwatarida-machi Kawasaki-ku, Kawasaki-shi JP - 210-0855 Tel. +81 44 328 76 01 info@beko-technologies.jp</p>	<p>Polska / Poland BEKO TECHNOLOGIES Sp. z o.o. ul. Pańska 73 PL - 00-834 Warszawa Tel. +48 22 314 75 40 Mobil +49 173 28 90 700 info.pl@beko-technologies.pl</p>
<p>South East Asia BEKO TECHNOLOGIES S.E.Asia (Thailand) Ltd. 75/323 Soi Romklao, Romklao Road Sansab Minburi Bangkok 10510 Tel. +66 2-918-2477 info.th@beko-technologies.com</p>	<p>臺灣 / Taiwan BEKO TECHNOLOGIES Co.,Ltd 16F.-5 No.79 Sec.1 Xintai 5th Rd., Xizhi City New Taipei City 221 Taiwan (R.O.C.) Tel. +886 2 8698 3998 info.tw@beko-technologies.tw</p>	<p>USA BEKO TECHNOLOGIES CORP. 900 Great Southwest Pkwy SW US - Atlanta, GA 30336 Tel. +1 404 924-6900 Fax +1 (404) 629-6666 beko@bekousa.com</p>

Original operating instructions in English.

Subject to technical changes / errors excepted.

DRYPOINT_RAX_200-500_NA_3PH_UL_manual_en_2020-04