



EN - english

Instructions for installation and operation

High pressure compressed air refrigeration dryer

DRYPOINT® RS 15-550 HP50 NA

Dear customer,

Thank you for deciding in favour of the DRYPOINT® RS 15-550 HP50 NA high pressure compressed-air refrigeration dryer. Please read these installation and operating instructions carefully before mounting and starting up the DRYPOINT® RS 15-550 HP50 NA and follow our directions. Perfect functioning of the DRYPOINT® RS 15-550 HP50 NA and thus reliable compressed-air drying can only be guaranteed when the provisions and notes stipulated here are strictly adhered to.

Contents

1	Name plate	5
2	Safety instructions	5
2.1	Safety pictograms in accordance with DIN 4844	6
2.2	Signal words in accordance with ANSI	8
2.3	Overview of the safety instructions	8
3	Proper use	10
4	Exclusion from a field of application	10
5	Operating instructions in accordance with the 2014/68/EU Pressure Equipment Directive	11
6	Transport	11
7	Storage	11
8	Installation	12
8.1	Place of installation	12
8.2	Installation plan	13
8.3	Correction factors	14
8.4	Connection to the compressed-air system	15
8.5	Connection to the cooling-water network	15
8.6	Minimum cooling water requirements:	16
8.7	Electrical connections	16
8.8	Condensate drain	17
9	Start-up	17
9.1	Preliminary stages	17
9.2	Initial start-up	18
9.3	Shut down and restart	19
10	Technical data	20
10.1	Technical data DRYPOINT RS 15-180 HP50 NA 1/115/60	20
10.2	Technical data DRYPOINT RS 15-550 HP50 NA 1/230/60	21
10.3	Technical data DRYPOINT RS 180-550 3phase HP50 NA 3/460/60	22
10.4	Technical data DRYPOINT RS 180-550 3phase HP50 NA 3/380/60	23
11	Technical description	24
11.1	Control panel	24
11.2	Functional description	24
11.3	Flow chart (air-cooled)	25
11.4	Flow chart (water-cooled)	25
11.5	Refrigerating compressor	26
11.6	Condenser (air-cooled)	26
11.7	Condenser (water-cooled)	26
11.8	Cooling-water regulating valve	26
11.9	Filter dryer	26
11.10	Capillary tube	26
11.11	Air-to-air heat exchanger	26
11.12	Air-to-refrigerant heat exchanger	26
11.13	Condensate separator	26
11.14	Hot-gas bypass valve	26
11.15	Refrigerant pressure switches LPS – HPS	27
11.16	Safety temperature switch TS	27
11.17	Compressor crankcase heater (RS 180-550 3phase)	27
11.18	Electronic controller DMC35 (RS 15-40)	28
11.18.1	How to switch on the dryer	28
11.18.2	How to switch off the dryer	28
11.18.3	How a service warning / alarm is displayed	28
11.18.4	How is controlled the condenser fan	29
11.18.5	How is controlled the drain solenoid valve	29
11.18.6	How to display the total hours of operation	29
11.18.7	How to change the operating parameters	29
11.19	Electronic controller DMC34	30
11.19.1	How to switch on the dryer	30
11.19.2	How to switch off the dryer	30
11.19.3	How to display the operating parameters	30

11.19.4	How a service warning / alarm is displayed	30
11.19.5	How is controlled the condenser fan	31
11.19.6	How is controlled the drain solenoid valve	31
11.19.7	How to reset the service reminder timer	31
11.19.8	Operation of the failure / alarm dry contact	31
11.19.9	How to change the operating parameters	31
11.20	Electronically level-controlled BEKOMAT condensate drain	32
12	Maintenance, troubleshooting, spare parts and dismantling	33
12.1	Checks and maintenance	33
12.2	Troubleshooting	34
12.4	Recommended spare parts	38
12.5	Maintenance works at the refrigeration cycle	39
12.6	Dismantling the dryer	39
13	Appendices	40
13.1	Dryer dimensions	40
13.1.1	Dryer dimensions DRYPOINT RS 15-40 HP50 NA	40
13.1.2	Dryer dimensions DRYPOINT RS 50-80 HP50 NA	41
13.1.3	Dryer dimensions DRYPOINT RS 100-140 HP50 NA	42
13.1.4	Dryer dimensions DRYPOINT RS 180-350 HP50 NA	43
13.1.5	Dryer dimensions DRYPOINT RS 450-550 HP50 NA	44
13.1.6	Dryer dimensions DRYPOINT RS 180-350 HP50 NA 3phase	45
13.1.7	Dryer dimensions DRYPOINT RS 450-550 HP50 NA 3phase	46
13.2	Exploded diagrams	47
13.2.1	Components of the exploded diagrams	47
13.2.2	Exploded diagram DRYPOINT RS 15-40 HP50 NA	48
13.2.3	Exploded diagram DRYPOINT RS 50-80 HP50 NA	49
13.2.4	Exploded diagram DRYPOINT RS 100-140 HP50 NA	50
13.2.5	Exploded diagram DRYPOINT RS 180-350 HP50 NA Air-Cooled	51
13.2.6	Exploded diagram DRYPOINT RS 180-350 HP50 NA Water-Cooled	52
13.2.7	Exploded diagram DRYPOINT RS 450-550 HP50 NA Air-Cooled	53
13.2.8	Exploded diagram DRYPOINT RS 450-550 HP50 NA Water-Cooled	54
13.2.9	Exploded diagram DRYPOINT RS 180-350 HP50 NA 3phase Air-Cooled	55
13.2.10	Exploded diagram DRYPOINT RS 180-350 HP50 NA 3phase Water-Cooled	56
13.2.11	Exploded diagram DRYPOINT RS 450-550 HP50 NA 3phase Air-Cooled	57
13.2.12	Exploded diagram DRYPOINT RS 450-550 HP50 NA 3phase Water-Cooled	58
13.3	Electric diagrams	59
13.3.1	Electric diagrams – list of components	59
13.3.2	Electric diagram DRYPOINT RS 15-40 HP50 NA	60
13.3.3	Electric diagram DRYPOINT RS 50-80 HP50 NA	61
13.3.4	Electric diagram DRYPOINT RS 100-140 HP50 NA	62
13.3.5	Electric diagram DRYPOINT RS 180-260 HP50 NA	63
13.3.6	Electric diagram DRYPOINT RS 350 HP50 NA	64
13.3.7	Electric diagram DRYPOINT RS 450-550 HP50 NA	65
13.3.8	Electric diagram DRYPOINT RS 180-350 HP50 NA 3phase Sheet 1/3	66
13.3.9	Electric diagram DRYPOINT RS 180-350 HP50 NA 3phase Sheet 2/3	67
13.3.10	Electric diagram DRYPOINT RS 180-350 HP50 NA 3phase Sheet 3/3	68
13.3.11	Electric diagram DRYPOINT RS 450-550 HP50 NA 3phase Sheet 1/3	69
13.3.12	Electric diagram DRYPOINT RS 450-550 HP50 NA 3phase Sheet 2/3	70
13.3.13	Electric diagram DRYPOINT RS 450-550 HP50 NA 3phase Sheet 3/3	71

1 Name plate

The name plate is on the back of the dryer and comprises all primary data of the device. Always refer to these when contacting the manufacturer or the sales department.

All guarantee claims will expire in the event that the name plate is modified or removed.

2 Safety instructions



Please check whether or not these instructions correspond to the device type.

Please adhere to all advice given in these operating instructions. They include essential information which must be observed during installation, operation and maintenance. Therefore, it must be ensured that these operating instructions are read by the fitter and the responsible operator / certified skilled personnel prior to installation, start-up and maintenance.

The operating instructions must be accessible at all times at the place of application of the DRYPOINT® RS 15-550 HP50 NA high pressure compressed-air refrigeration dryer.

In addition to these operating instructions, local and national regulations need to be observed, where required .

Ensure that operation of the DRYPOINT® RS 15-550 HP50 NA high pressure compressed-air refrigeration dryer only takes place within the permissible limit values indicated on the name plate. Any deviation from these limit values involves a risk for persons and for the material, and may result in malfunction or a breakdown.

After installing the device correctly and in accordance with the instructions in this manual, the dryer is ready to operate, further settings are not required. Operation is fully automatic and maintenance is limited to several examinations and cleaning measures which are described in the following chapters.

This manual must be available at all times for future reference and is a constituent part of the dryer.

If you have any queries regarding these installation and operating instructions, please contact BEKO TECHNOLOGIES.

Safety instructions

2.1 Safety pictograms in accordance with DIN 4844



Observe operating instructions



General danger symbol



Supply voltage



Danger: component or system under pressure



Hot surfaces



Non-breathable air



Do not use water to extinguish the fire



Do not operate with open cover (housing)



Maintenance works or controlling measures must only be carried out by qualified personnel¹



Do not smoke



Note



Connection point compressed-air inlet



Connection point compressed-air outlet



Connection point condensate drain

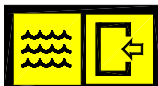

Connection point cooling-water inlet (water-cooled)



Connection point cooling-water outlet (water-cooled)

¹ Certified skilled personnel are persons who are authorised by the manufacturer, with experience and technical training, who are well-grounded in the respective provisions and laws and capable of carrying out the required works and of identifying and avoiding any risks during the machine transport, installation, operation and maintenance. Qualified and authorised operators are persons who are instructed by the manufacturer regarding the handling of the refrigeration system, with experience and technical training, and who are well-grounded in the respective provisions and laws.



Works can be carried out by the operator of the plant, provided that they are skilled accordingly².

NOTE: Text that contains important specifications to be considered – does not refer to safety precautions.



The device was carefully designed with particular attention paid to environmental protection:

- CFC-free refrigerants
- CFC-free insulation material
- Energy-saving design
- Limited acoustic emissions
- Dryer and packaging comprise reusable materials

This symbol advises the user to observe the environmental aspects and comply with the recommendations connected with this symbol.

² Certified skilled personnel are persons who are authorised by the manufacturer, with experience and technical training, who are well-grounded in the respective provisions and laws and capable of carrying out the required works and of identifying and avoiding any risks during the machine transport, installation, operation and maintenance. Qualified and authorised operators are persons who are instructed by the manufacturer regarding the handling of the refrigeration system, with experience and technical training, and who are well-grounded in the respective provisions and laws.

2.2 Signal words in accordance with ANSI

Danger!	Imminent hazard Consequences of non-observance: serious injury or death
Warning!	Potential hazard Consequences of non-observance: possible serious injury or death
Caution!	Imminent hazard Consequences of non-observance: possible injury or property damage
Notice!	Potential hazard Consequences of non-observance: possible injury or property damage
Important!	Additional advice, info, hints Consequences of non-observance: disadvantages during operation and maintenance, no danger

2.3 Overview of the safety instructions



Certified skilled personnel

Installation works must exclusively be carried out by authorised and qualified skilled personnel. Prior to undertaking any measures on the DRYPOINT® RS 15-550 HP50 NA high pressure compressed-air refrigeration dryer, the certified skilled personnel shall read up on the device by carefully studying the operating instructions. The operator is responsible for the adherence to these provisions. The respective directives in force apply to the qualification and expertise of the certified skilled personnel.

For safe operation, the device must only be installed and operated in accordance with the indications in the operating instructions. In addition, the national and operational statutory provisions and safety regulations, as well as the accident prevention regulations required for the respective case of application, need to be observed during employment. This applies accordingly when accessories are used.



Danger!

Compressed air!

Risk of serious injury or death through contact with quickly or suddenly escaping compressed air or through bursting and/or unsecured plant components.

Compressed air is a highly dangerous energy source.

Never work on the dryer when the system is under pressure.

Never direct the compressed-air outlet or condensate drain hoses at persons.

The user is responsible for the proper installation of the dryer. Non-observance of the instructions in the "Installation" chapter leads to the expiration of the guarantee. Improper installation may result in dangerous situations for the personnel and/or the device.



Danger!

Supply voltage!

Contact with non-insulated parts carrying supply voltage involves the risk of an electric shock resulting in injuries and death.

Only qualified and skilled personnel are authorised to run electrically-operated devices. Prior to undertaking maintenance measures at the device, the following requirements must be met:

Make sure that the power supply is switched off and that the device is off and marked for maintenance measures. Please also ensure that the power supply cannot be re-established during the works.



Caution!

Refrigerant!

The compressed-air refrigeration dryer uses HFC-containing refrigerants as a coolant.

Please observe the corresponding paragraph entitled "Maintenance works at the refrigeration cycle".

**Warning!****Refrigerant leak!**

A refrigerant leak involves the danger of serious injury and damage to the environment.



The DRYPOINT® RS 15-550 HP50 NA high pressure compressed-air refrigeration dryer contains fluorinated greenhouse gas/refrigerant.



Installation, repair and maintenance works at the refrigeration system must only be carried out by certified skilled personnel (specialists). A certification in accordance with EC regulation 303/2008 must be available.



The requirements of the EC 842/2006 directive must be met under all circumstances.

Please refer to the indications on the name plate as regards the type and amount of refrigerant.



Comply with the following protective measures and rules of conduct:

1. **Storage:** Keep the container tightly closed. Keep it in a cool and dry place. Protect it against heat and direct sunlight. Keep it away from ignition sources.
2. **Handling:** Take measures against electrostatic charging. Ensure good ventilation/suction at the workplace. Check fittings, connections and ducts for tightness. Do not inhale the gas. Avoid contact with the eyes or the skin.
3. Prior to carrying out works on refrigerant-carrying parts, remove the refrigerant to such an extent that safe working is possible.
4. Do not eat, drink or smoke during work. Keep out of the reach of children.
5. **Breathing protection:** ambient-air-independent respirator (at high concentrations).
6. **Eye protection:** sealing goggles.
7. **Hand protection:** protective gloves (e.g. made of leather).
8. **Personal protection:** protective clothing.
9. **Skin protection:** use protective cream.

In addition, the safety data sheet for the refrigerant needs to be observed!

**Caution!****Hot surfaces!**

During operation, several components can reach surface temperatures of more than 140°F (60°C). There is the risk of burns.

All components concerned are installed inside of the closed housing. The housing must only be opened by certified skilled personnel³.

**Caution!****Improper use!**

The device is intended for the separation of water in compressed air. The dried air cannot be used for breathing-air purposes and is not suitable for the direct contact with food.

This dryer is not suitable for the treatment of contaminated air or of air containing solids.

³ Certified skilled personnel are persons who are authorised by the manufacturer, with experience and technical training, who are well-grounded in the respective provisions and laws and capable of carrying out the required works and of identifying and avoiding any risks during the machine transport, installation, operation and maintenance. Qualified and authorised operators are persons who are instructed by the manufacturer regarding the handling of the refrigeration system, with experience and technical training, and who are well-grounded in the respective provisions and laws.



Note!

Contaminated intake air!

In the event that the intake air is strongly contaminated (ISO 8573.1 class 3.-3 or poorer quality), we recommend the additional installation of a prefilter (e.g. CLEARPOINT HP50S040), to avoid clogging of the heat exchanger.



Caution!

Heating-up through fire!

In the event of a heating-up through fire, the containers and pipes of the refrigerant system can burst.



In this case, please proceed as follows:

- Switch off the refrigeration plant.
- Switch off the mechanical ventilation of the machinery compartment.
- Use ambient-air-independent respirators.

Containers and plants which are filled with refrigerant can burst violently in the event of fire.

The refrigerants themselves are incombustible, but they are degraded to very toxic products at high temperatures.

Remove the container/plant from the fire zone, as there is the risk of bursting!

Cool down containers and bottles via a directed water jet from a safe position.

In the event of fire, please use an approved fire extinguisher. Water is not a suitable agent to extinguish an electrical fire.

This must only be carried out by persons who are trained and informed about the hazards emanating from the product.



Caution!

Unauthorised intervention!

Unauthorised interventions may endanger persons and plants and lead to malfunction.

Unauthorised interventions, modification and abuse of the pressure devices are prohibited.

The removal of sealings and leadings at safety devices is prohibited.

Operators of the devices must observe the local and national pressure equipment regulations in the country of installation.



Note!

Ambient conditions!

In the event that the dryer is not installed under suitable ambient conditions, the ability of the device to condense refrigerant gas is impaired. This can result in a higher load of the refrigerating compressor, and in a loss of efficiency and performance of the dryer.

This in turn leads to overheated condenser fan motors, to malfunction of electric components and to a breakdown of the dryer. Failures of this type will affect warranty considerations.

Do not install the dryer in an environment in which chemicals with a corrosive effect, explosive gases, toxic gases, evaporation heat, high ambient temperatures or extreme dust and dirt can be found.

3 Proper use

This dryer was designed, manufactured and tested to separate the moisture which normally exists in compressed air. Any other use is considered improper.

The manufacturer shall not be liable for problems occurring as a consequence of improper use. The user alone is responsible for any damage resulting from that.

Furthermore, the correct use includes the compliance with the installation instructions, in particular in respect of:

- The voltage and frequency of the main voltage supply.
- The pressure, temperature and flow rate of the inlet air.
- The pressure, temperature and cooling-water throughput (water-cooled).
- The ambient temperature.

When delivered, the dryer is tested and fully assembled. The customer only needs to connect the device to the system in accordance with the instructions in the following chapters.

4 Exclusion from a field of application



Note!

Improper use!



The device is intended for the separation of water in compressed air. The dried air cannot be used for breathing-air purposes and is not suitable for the direct contact with food.

This dryer is not suitable for the treatment of contaminated air or of air containing solids.

Pressure Equipment Directive

5 Operating instructions in accordance with the 2014/68/EU Pressure Equipment Directive

The DRYPOINT® RS 15-550 HP50 NA high pressure compressed-air refrigeration dryer contains pressure equipment in the sense of the 2014/68/EU Pressure Equipment Directive. Therefore, the entire plant needs to be registered with the supervisory authority if required in accordance with the local regulations.

For the examination prior to the start-up and for periodic inspections, the national regulations need to be observed, such as the industrial safety regulation in the Federal Republic of Germany. In countries outside the EU, the respective regulations in force there need to be adhered to.

The proper use of pressure devices is the basic requirement for safe operation. As regards pressure devices, the following points need to be observed:

- The DRYPOINT® RS 15-550 HP50 NA high pressure compressed-air refrigeration dryer must only be employed within the pressure and temperature range limits indicated by the manufacturer on the name plate.
- No welding must be carried out on the pressure parts.
- The DRYPOINT® RS 15-550 HP50 NA high pressure compressed-air refrigeration dryer must neither be installed in insufficiently ventilated rooms nor near heat sources or inflammable substances.
- To avoid fractures resulting from material fatigue, the refrigeration dryer should not be exposed to vibrations during operation.
- The maximum operating pressure indicated by the manufacturer on the name plate must not be exceeded. It is the installer's responsibility to install the appropriate safety and control devices. Prior to the start-up of the DRYPOINT® RS 15-550 HP50 NA high pressure compressed-air refrigeration dryer, the connected pressure generator (compressor etc.) must be set to the max. permissible operating pressure. The integrated safeguard needs to be checked by an approved inspection agency.
- The documents related to the DRYPOINT® RS 15-550 HP50 NA high pressure compressed-air refrigeration dryer (manual, operating instructions, manufacturer's declaration etc.) must be kept safe for future reference.
- No objects whatsoever must be installed at or placed on the DRYPOINT® RS 15-550 HP50 NA high pressure compressed-air refrigeration dryer and the connecting lines.
- Installation of the plant in frost-free places only.
- Operation of the plant is only permissible with fully closed and intact housing and cover panels. Operation of the plant with damaged housing/cover panels is prohibited.

6 Transport

Check the packaging for visible loss or damage. If no visible damage can be ascertained, place the unit in close proximity to the place of installation and unpack the device.

During this procedure, the dryer must always remain in an upright position. The components may be damaged when the unit is tilted or turned upside down.

Store the device in a dry environment and do not expose it to extreme weather conditions.

Handle with care. Strong shocks can cause irreparable damage.

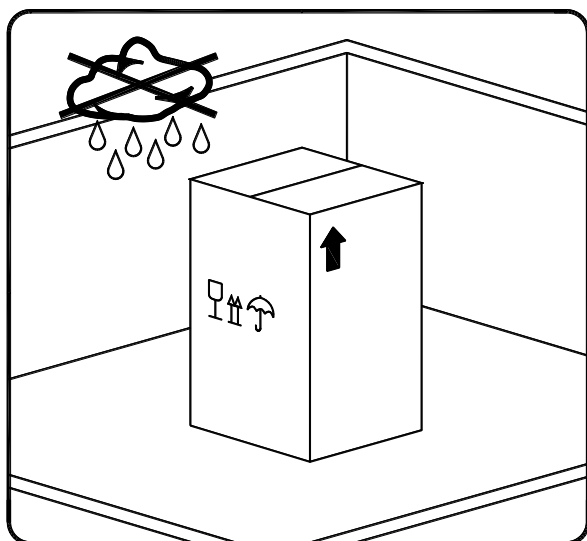
7 Storage

Keep the device away from extreme weather conditions even when packaged.

Keep the dryer in an upright position, also while it is stored. Tilting the device or turning it upside down can cause irreparable damage to some components.

When the dryer is not in use, it can be stored in its packaging in a dust-free and protected place at a temperature of up to max. 122°F (50°C) and at a specific humidity of max. 90%. If the storage period exceeds 12 months, you should contact the manufacturer.



The packaging material is recyclable. Dispose of the material in accordance with the directives and provisions in force in the country of destination

8 Installation

8.1 Place of installation



Note!

Ambient conditions!

In the event that the dryer is not installed under suitable ambient conditions, the ability of the device to condense refrigerant gas is impaired. This can result in a higher load of the refrigerating compressor, and in a loss of efficiency and performance of the dryer.

This in turn leads to overheated condenser fan motors, to malfunction of electric components and to a breakdown of the dryer. Failures of this type will affect warranty considerations.

Do not install the dryer in an environment in which chemicals with a corrosive effect, explosive gases, toxic gases, evaporation heat, high ambient temperatures or extreme dust and dirt can be found.

Minimum installation requirements:

- Choose an area which is clean and dry, free from dust and protected against atmospheric disturbances.
- The load-bearing zone must be even, horizontal and able to bear the weight of the dryer.
- Minimum ambient temperature +34°F (+1°C).
- Maximum ambient temperature +122°F (+50°C).
- Ensure a proper cooling air replacement.
- Allow a sufficient clearance on each side of the dryer for proper ventilation and to facilitate maintenance operations. The dryer does not require attachment to the floor surface.



Do not obstruct the ventilation grille (not even partially).

Prevent any recirculation of the outgoing cooling air.

Protect the dryer against draughts.



Note!

Dryers models RS 15 – 80 can be wall-mounted. See fixing dimensions on dimensional drawings in the appendices section.

The hanging mounting inevitably causes the obstruction of the ventilation grid positioned on the panel facing the wall fixing. This obstruction, in any case, does not prejudice the efficiency of the ventilation inside the dryer which is guaranteed by other grids on the other panels.

8.2 Installation plan

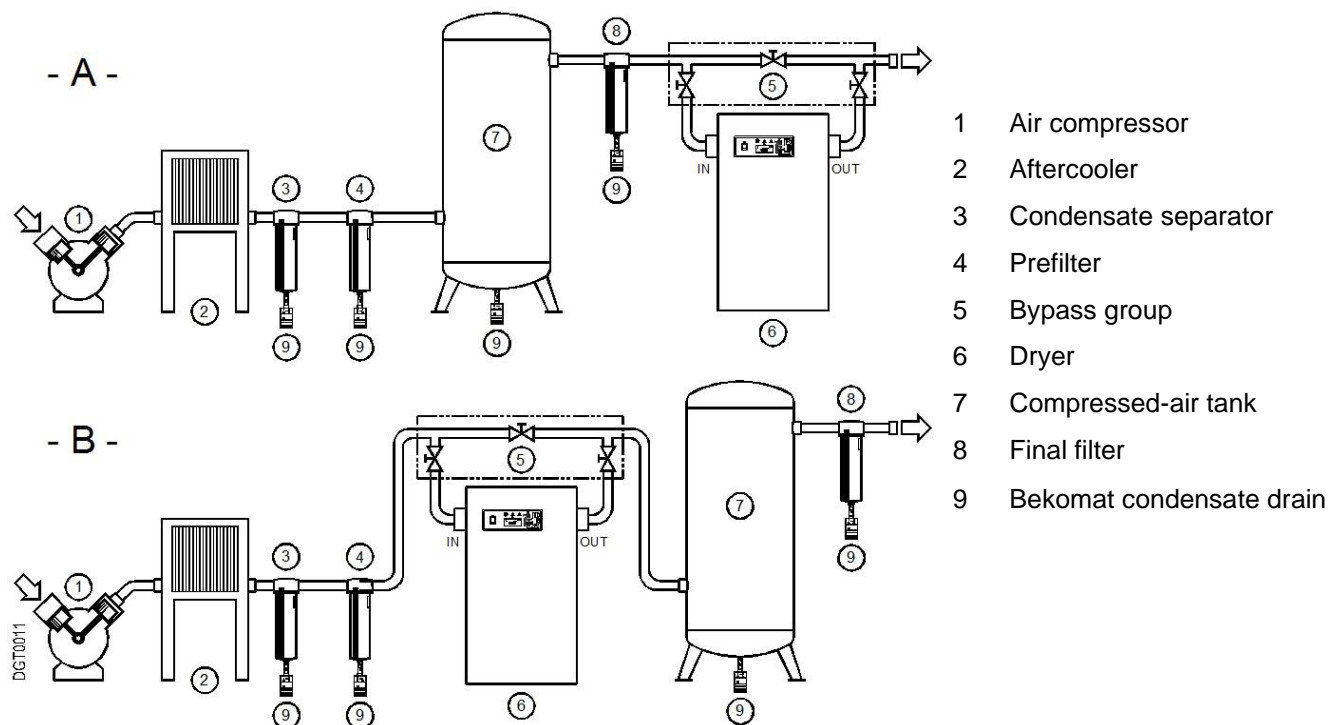

Installation **type A** is recommended when the total consumption corresponds to the throughput rate of the compressor. Installation **type B** is recommended when the air consumption constantly varies, with peak values which considerably exceed the throughput rate of the compressor. The storage capacity of the tank must be dimensioned in such a way that a possible short-term high air demand (peak air consumption) can be compensated.



Do not obstruct the ventilation grille (not even partially).

Prevent any recirculation of the outgoing cooling air.

Protect the dryer against draughts.



Note!

Contaminated intake air!

In the event that the intake air is strongly contaminated (ISO 8573.1 class 3.-3 or poorer quality), we recommend the additional installation of a prefilter (e.g. CLEARPOINT HP50S040), to avoid clogging of the heat exchanger.

Installation

8.3 Correction factors

Correction factor for operating pressure modifications:

Inlet air pressure	psig	200	300	400	500	550	580	650	725
	barg	14	21	28	34	38	40	45	50
Factor (F1)		0.53	0.71	0.84	0.94	0.98	1.00	1.05	1.10

Correction factor for ambient temperature modifications (Air-Cooled):

Ambient temperature	°F	≤ 80	90	95	100	105	110	115	122
	°C	≤ 27	32	35	38	40	43	45	50
Factor (F2)		1.11	1.09	1.06	1.00	0.94	0.87	0.78	0.69

Correction factor for inlet air temperature modifications:

Air temperature	°F	≤ 90	100	110	122	130	140	150
	°C	≤ 32	38	43	50	55	60	65
Factor (F3)		1.16	1.00	0.82	0.68	0.61	0.52	0.45

Correction factor for DewPoint modifications:

DewPoint	°F	38	41	45	50
	°C	3	5	7	10
Factor (F4)		1.00	1.08	1.20	1.36

Calculation of the actual air throughput:

Actual air throughput = air throughput acc. to planning x factor (F1) x factor (F2) x factor (F3) x factor (F4)

Example:

The **DRYPOINT RS 100 HP50 NA** has a planned nominal capacity of 100 scfm (170 m³/h). The highest achievable air mass under the following operating conditions is:

Air inlet pressure = 550 psig (38 barg)	⇒	⇒ Factor (F1) = 0.98
Ambient temperature = 115°F (45°C)	⇒	⇒ Factor (F2) = 0.78
Air inlet temperature = 122°F (50°C)	⇒	⇒ Factor (F3) = 0.68
Pressure dew point = 50°F (10°C)	⇒	⇒ Factor (F4) = 1.36

Every function parameter corresponds to a numerical factor which, multiplied by the planned nominal capacity, determines the following:

$$\text{Actual air throughput} = 100 \times 0.98 \times 0.78 \times 0.68 \times 1.36 = 71 \text{ scfm (121 m}^3\text{/h)}$$

71 scfm is the maximum flow rate of the dryer under the aforementioned operating conditions.

Selection of the best suitable model in accordance with the operating conditions:

$$\text{Air throughput acc. to planning} = \frac{\text{Requ. air throughput}}{\text{Factor (F1) x Factor (F2) x Factor (F3) x Factor (F4)}}$$

Example:

The following operating parameters are known:

Required air mass = 100 scfm (170 m ³ /h)	⇒	⇒ Factor (F1) = 0.98
Air inlet pressure = 550 psig (38 barg)	⇒	⇒ Factor (F2) = 0.78
Ambient temperature = 115°F (45°C)	⇒	⇒ Factor (F3) = 0.82
Air inlet temperature = 110°F (43°C)	⇒	⇒ Factor (F4) = 1.36
Pressure dew point = 50°F (10°C)	⇒	

To find out the correct dryer version, the required air mass must be divided by the correction factors of the parameters indicated above:

$$\text{Air throughput acc. to planning} = \frac{100}{0.98 \times 0.78 \times 0.82 \times 1.36} = 117 \text{ scfm (199 m}^3\text{/h)}$$

The suitable model for these requirements is **DRYPOINT RS 140 HP50 NA** (with a spec. nominal capacity of 140 scfm (238 m³/h)).

8.4 Connection to the compressed-air system



Danger! **Compressed air!**

All works must only be carried out by qualified skilled personnel.



Never work on compressed-air systems which are under pressure.

The operator or the user must ensure that the dryer is never operated with a pressure exceeding the maximum pressure value indicated on the name plate.

Exceeding the maximum operating pressure can be dangerous for the operator but also for the device.

The air temperature and the air flow at the inlet of the dryer must lie within the limit values indicated on the name plate. The connecting lines must be free from dust, iron rust, shards and other contaminations and correspond to the flow rate of the dryer. Should air with a very high temperature be treated, the installation of an aftercooler may be necessary. For the implementation of maintenance works, the installation of a bypass system is recommended.

Note!



Pulsation and vibrations!

Pulsations and vibrations must be eliminated from the compressed air and IN/OUT piping to avoid possible fatigue failure.

Do not use the dryer to treat air containing corrosive substances for copper and its alloys..

Note!



Contaminated intake air!

In the event that the intake air is strongly contaminated (ISO 8573.1 class 3.-3) or poorer quality, we recommend the additional installation of a prefilter (e.g. CLEARPOINT HP50S040), to avoid clogging of the heat exchanger.

8.5 Connection to the cooling-water network



Danger! **Compressed air and unqualified personnel!**

All works must only be carried out by qualified skilled personnel.

Never work on compressed-air systems which are under pressure.



The user must ensure that the dryer is never operated with a pressure exceeding the nominal values.

Possible overpressure can be dangerous for the operator but also for the device.

The temperature and the amount of cooling water need to correspond to the limit values indicated on the name plate. The cross-section of the connecting lines, which should preferably be flexible, must be free from dust, iron rust, shards and other contaminations. We recommend employing connecting lines (flexible hoses, vibration-inhibiting fittings etc.) which protect the dryer against possible vibrations in the pipework.

Note!



Contaminated intake water!

In the event that the intake water is strongly contaminated we recommend the additional installation of a prefilter (500 micron), to avoid clogging of the heat exchanger.

Installation

8.6 Minimum cooling water requirements:

Temperature	15 ... 30°C (1)	Residual solid particles	<30 mg/l or ppm
Pressure	3...10 bar(g) (2)	Cl ⁻	<5 mg/l or ppm
Delivery pressure	> 3 bar (2) (3)	Cl ₂	<0.5 mg/l or ppm
PH	7.5...9.0	Oxygen content	<0.1 mg/l or ppm
Total hardness	6.0...15 °dH	CO ₂	<50 mg/l or ppm
Conductivity	10...500 µS/cm or µmho/cm	H ₂ S	<0.05 mg/l or ppm
SO ₄ ²⁻	<100 mg/l or ppm	PO ₄ ³⁻	<2 mg/l or ppm
HCO ₃ ⁻ / SO ₄	>1.0 mg/l or ppm	Fe	<0.2 mg/l or ppm
NH ₃	<0.5 mg/l or ppm	Mn	<0.1 mg/l or ppm
Free aggressive carbonic acid	<20 mg/l or ppm	NO ₃ ⁻	<100 mg/l or ppm
NH ₄ ⁺	<2 mg/l or ppm	NO ₂ ⁻	<0.1 mg/l or ppm
Saturation mark SI	-0.2 < 0 < 0.2	S ²⁻	<1 mg/l or ppm
HCO ₃	<300 mg/l or ppm		

- Note:
- (1) – Other temperatures upon request – check the data on the name plate.
 - (2) – Other pressures upon request – check the data on the name plate.
 - (3) – Pressure difference at the water connection of the dryer at maximum water flow. Other delivery pressures upon request.



CAUTION!

During the piping of the dryer, the inlet and outlet connections need to be supported as is shown in the illustration.

Non-observance will cause damage.

8.7 Electrical connections



Danger!

Supply voltage!

The connection to the electric mains should only be carried out by qualified skilled personnel and must correspond to the legal provisions in force in your region.

Prior to connecting the device, please check the name plate to avoid exceeding the indicated values. The voltage tolerance is +/- 10%.

DRYPOINT RS 15-550 HP50 NA dryers are supplied with a power cord and safety plug (two-pole and earth connection) or with a junction box on the back plate.

Make sure that suitable fuses or circuit breakers in accordance with the indications on the name plate are available.

The wall socket must be equipped with a fault current circuit breaker (I_{Δn}=0.03A) which must be adjusted according to the power consumption of the dryer (see nominal values on the name plate of the dryer). The cross-section of the power supply cable must correspond to the power consumption of the dryer. In this respect, the ambient temperature, the cable laying conditions, the length of the cables and the requirements of the local electricity supplier need to be considered.



Danger!

Supply voltage and missing earth connection!

Important: ensure that the plant is connected to earth.

Do not use plug adapters at the power plug.

Possible replacement of the power plug must only be carried out by a qualified electrician.

8.8 Condensate drain



Danger!
Compressed air and condensate under pressure!

The condensate is discharged at system pressure.



The drain pipe needs to be secured.

Never direct the condensate drain pipe at persons.

The dryer is delivered with an already integrated electronically level-controlled BEKOMAT condensate drain. Connect the condensate drain with a collection system or container by properly screwing it on.

Do not connect the drain with pressurised plants.



Do not discharge the condensate into the environment.

The condensate accumulating in the dryer contains oil particles which were released into the air by the compressor.

Dispose of the condensate in accordance with the local provisions.

It is advisable to install a water-oil separator, to which the total amount of condensate from the compressors, dryers, tanks, filters etc. is supplied.

We recommend ÖWAMAT oil-water separators for dispersed compressor condensate and BEKOSPLIT emulsion-splitting plants for emulsified condensate.

9 Start-up

9.1 Preliminary stages



Note!
Exceeding of the operating parameters!

Ensure that the operating parameters comply with the nominal values indicated on the name plate of the dryer (voltage, frequency, air pressure, air temperature, ambient temperature etc.).

Prior to delivery, this dryer was thoroughly tested, packed and checked. Please verify the soundness of the dryer during the initial start-up and check the perfect functioning during the first operating hours.



The initial start-up must be carried out by qualified personnel.

During the installation and operation of this device, all national regulations regarding electronics and any other federal and state ordinances, as well as local provisions, need to be adhered to.



The operator and the user must ensure that the dryer is not operated without panels.

9.2 Initial start-up



Note!

The dryer **must not be started up more than six times an hour**. Wait at least five minutes prior to every restart.

The user is responsible for the compliance with these provisions. Irreparable damage can be caused by starting up the device too often.



The method below should be applied during the first start-up, after longer downtimes or subsequent to maintenance works.

The start-up must be carried out by certified skilled personnel.

Processing sequence (see Section 11.1 "Control panel")

- Ensure that all steps of the "Installation" chapter have been carried out.
- Ensure that the connection to the compressed-air system is in accordance with the provisions and that the lines are fixed and supported properly.
- Ensure that the condensate drain pipe is fixed in accordance with the provisions and that it is connected with a collection system or a container.
- Ensure that the bypass system (if installed) is open and that the dryer is disconnected from the compressed-air system.
- Ensure that the manual valve of the condensate drainage cycle is open.
- Ensure that the cooling-water flow and the cooling-water temperature are in accordance with the provisions (water-cooled).
- Remove any packaging material and other items which may block the space around the dryer.
- Establish the mains connection (plug into socket).
- RS 180-550 3phase - switch on the main switch - pos. A control panel.
- RS 180-550 3phase - wait at least two hours before starting the dryer (the crankcase heater of the compressor needs to heat up the compressor oil).
- Start the dryer by switching on the main switch on the control panel (pos. 1).
- Make sure that the electronic control unit is switched on.
- Ensure that the power consumption complies with the values on the name plate.
- Ensure that the fan runs properly – **wait for the first interventions (air-cooled)**.
- Wait until the dew point remains stable.
- Slowly open the air inlet valve.
- Slowly open the air outlet valve.
- Slowly close the central bypass valve of the system (if installed).
- Check the pipes for air leakage.
- Ensure the proper functioning of the condensate drain cycle (wait for the first condensate discharges).



Note!

RS 15-40 - A dew point included in the green operating area of the electronic control unit is considered to be correct according to the possible operating conditions (flow rate, air inlet temperature, ambient temperature etc.).

RS 50-550 - A dew point between 32°F (0°C) and +50°F (+10°C) displayed on the electronic control unit is considered to be correct according to the possible operating conditions (flow rate, air inlet temperature, ambient temperature etc.).

During the operation, the refrigerating compressor runs continuously. The dryer needs to be switched on during the entire compressed-air usage time, even if the compressed-air compressor works periodically.

9.3 Shut down and restart



RS 180-550 3phase - during short-term inactivity (max. two to three days), it is advisable to leave the dryer and the control panel connected to the supply current circuit. Otherwise, it would be necessary at a restart of the dryer to wait two hours, until the crankcase heater of the compressor has heated up the oil in the compressor.



Shut down (see Section 11.1 "Control panel")

- Ensure that the dew point temperature indicated on the electronic control unit is stable.
- Interrupt the compressed-air supply.
- After a few minutes, stop the dryer by switching off the main switch on the control panel (pos. 1).



Restart (see Section 11.1 "Control panel")

- Make sure that the condenser is clean (air-cooled).
- Ensure that the cooling-water flow and the temperature are in accordance with the provisions (water-cooled).
- Check whether or not voltage is applied at the dryer.
- Start the dryer by switching on the main switch on the control panel (pos. 1).
- Ensure that the electronic control unit is switched on.
- Wait a few minutes and then check, whether or not the dew point temperature indicated on the electronic control unit is stable and whether or not the condensate is drained off at regular intervals.
- Establish the compressed-air supply.



RS 180-550 3phase - dryer remote control ON/OFF

- Remove the jumper between terminals 1 and 2 of the terminal strip and wire a potential-free contact (see electric diagram).
- Switch ON the main switch - pos. 1 on the control panel.
- Close the contact at terminals 1 and 2 to switch on the dryer.
- Open the contact at terminals 1 and 2 to switch off the dryer.



Only use potential-free contacts that are suitable for low voltage. Ensure the sufficient insulation of potentially dangerous voltage-carrying components.



Caution!

Automatic restart / remote control ON/OFF. The unit may start up without any active influence! The user will be responsible for the installation of proper protections for possible sudden power restoration to the dryer.

During the operation, the refrigerating compressor runs continuously. The dryer needs to be switched on during the entire compressed-air usage time, even if the compressed-air compressor works periodically.



Note!

RS 15-40 - A dew point included in the green operating area of the electronic control unit is considered to be correct according to the possible operating conditions (flow rate, air inlet temperature, ambient temperature etc.).

RS 50-550 - A dew point between 32°F (0°C) and +50°F (+10°C) displayed on the electronic control unit is considered to be correct according to the possible operating conditions (flow rate, air inlet temperature, ambient temperature etc.).



Note!

The dryer **must not be started up more than six times an hour**. Wait at least five minutes prior to every restart. The user is responsible for the compliance with these provisions. Irreparable damage can be caused when starting up the device too often.

10 Technical data

10.1 Technical data DRYPOINT RS 15-180 HP50 NA 1/115/60

MODEL	DP RS HP50 NA	15-P	30-P	40-P	50-P	80-P	100-P	140-P	180-P
Air flow rate at nominal condition (1)	[scfm] [m ³ /h] [l/min]	15 25 425	30 50 850	40 68 1133	50 85 1416	80 136 2265	100 170 2832	140 238 3965	180 306 5097
Pressure DewPoint at nominal condition (1)	[°F (°C)]	38 (3)							
Nominal ambient temperature	[°F (°C)]	100 (38)							
Min...Max ambient temperature	[°F (°C)]	34...122 (1...50)							
Nominal inlet air temperature	[°F (°C)]	100 (38) max.150 (65)							
Nominal inlet air pressure	[psig (barg)]	580 (40)							
Max. inlet air pressure	[psig (barg)]	725 (50)							
Air pressure drop - Δp	[psi (bar)]	3.63 (0.25)	3.48 (0.24)	3.63 (0.25)	3.34 (0.23)	3.34 (0.23)	3.48 (0.24)	3.48 (0.24)	2.90 (0.20)
Inlet - Outlet connections	[NPT-F]	3/8"				3/4"		1"	

		R134.a				R407C			
Refrigerant type		R134.a							
Refrigerant quantity (2)	[oz (kg)]	5.1/4 (0.15)	8.1/2 (0.24)	10.1/2 (0.30)	13.1/2 (0.38)	17.1/4 (0.49)	18 (0.51)	26.1/2 (0.75)	
Cooling air fan flow	[cfm (m ³ /h)]	180 (300)							
Heat Rejection	[btu/hr (kW)]	1800 (0.53)	2290 (0.67)	4090 (1.20)	4810 (1.44)	6790 (1.99)	12900 (3.78)	13100 (3.84)	13500 (3.96)
Standard Power Supply (2)	[PhV/Hz]	1/115/60							
Nominal electric consumption	[kW]	0,16	0,22	0,33	0,41	0,49	0,86	0,89	0,94
Full Load Amperage FLA	[A]	1,5	2,0	3,0	3,7	4,4	7,6	8,2	8,6
Max. noise level at 1 m	[dba]	3,1	4,5	5,3	7,1	8,7	12,5		12,6
Weight	[lb (kg)]	62 (28)	64 (29)	71 (32)	84 (38)	86 (39)	110 (50)	117 (53)	196 (89)

		R407C	
Refrigerant type		R407C	
Refrigerant quantity (2)	[oz (kg)]	24 (0.68)	
Max. cooling water inlet temp (3)	[°F (°C)]	86 (30)	
Min...Max. cooling water inlet pressure	[psig (barg)]	45...145 (3...10)	
Cooling water flow at 15°C	[US gpm (m ³ /h)]	0.53 (0.12)	
Cooling water flow at 30°C	[US gpm (m ³ /h)]	1.94 (0.44)	
Heat Rejection	[btu/hr (kW)]	13500 (3.96)	
Control of cooling water flow		Automatic by valve	
Cooling water connection	[NPT-F]	1/2"	
Standard Power Supply (2)	[PhV/Hz]	1/115/60	
Nominal electric consumption	[kW]	0,85	
Full Load Amperage FLA	[A]	7,8	
Max. noise level at 1 m	[dba]	11,8	
Weight	[lb (kg)]	< 70	
Weight	[lb (kg)]	187 (85)	

(1) The nominal condition refers to an ambient temperature of 100°F (38°C) with inlet air at 580 psig (40 barg) and 100°F (38°C).

(2) Check the data shown on the identification plate.

(3) Other temperature on request.

Technical data

10.3 Technical data DRYPOINT RS 180-550 3phase HP50 NA 3/460/60

MODEL	DP RS HP50 NA	180-R	260-R	350-R	450-R	550-R
Air flow rate at nominal condition (1)	[scfm]	180	260	350	450	550
	[m ³ /h]	306	442	595	765	935
	[l/min]	5097	7362	9911	12743	15575
Pressure DewPoint at nominal condition (1)	[°F (°C)]	38 (3)				
Nominal ambient temperature	[°F (°C)]	100 (38)				
Min...Max ambient temperature	[°F (°C)]	34...122 (1...50)				
Nominal inlet air temperature	[°F (°C)]	100 (38) max.150 (65)				
Nominal inlet air pressure	[psig (barg)]	580 (40)				
Max. inlet air pressure	[psig (barg)]	725 (50)				
Air pressure drop - Δp	[psi (bar)]	2.90 (0.20)	3.19 (0.22)		3.34 (0.23)	3.19 (0.22)
Inlet - Outlet connections	[NPT-F]	1"			1.1/2"	

Air-Cooled	Refrigerant type	R134.a			R407C		
	Refrigerant quantity (2)	[oz (kg)]	31.3/4 (0.90)	34.1/2 (0.98)	51.1/4 (1.45)	63.1/2 (1.80)	68.3/4 (1.95)
	Cooling air fan flow	[cfm (m ³ /h)]	1470 (2500)	1650 (2800)		2100 (3600)	2200 (3700)
	Heat Rejection	[btu/hr (kW)]	13700 (4.02)	14200 (4.16)	14900 (4.37)	24900 (7.30)	32300 (9.47)
	Standard Power Supply (2)	[Ph/V/Hz]	3/460/60				
	Nominal electric consumption	[kW]	1,13	1,28	1,31	2,50	2,75
		[A]	1,8	1,9	2,0	3,9	4,2
	Full Load Amperage FLA	[A]	2,8			6,4	7,4
	Max. noise level at 1 m	[dbA]	< 70				
	Weight	[lb (kg)]	209 (95)	236 (107)	265 (120)	357 (162)	414 (188)

Water-Cooled	Refrigerant type	R134.a			R407C		
	Refrigerant quantity (2)	[oz (kg)]	28.1/4 (0.80)	31.3/4 (0.90)	45.3/4 (1.30)	56.1/2 (1.60)	63.1/2 (1.80)
	Max. cooling water inlet temp (3)	[°F (°C)]	86 (30)				
	Min...Max. cooling water inlet pressure	[psig (barg)]	45...145 (3...10)				
	Cooling water flow at 15°C	[US gpm (m ³ /h)]	0.48 (0.11)	0.57 (0.13)	0.62 (0.14)	0.84 (0.19)	0.97 (0.22)
	Cooling water flow at 30°C	[US gpm (m ³ /h)]	1.89 (0.43)	2.03 (0.46)	2.33 (0.53)	3.17 (0.72)	3.48 (0.79)
	Heat Rejection	[btu/hr (kW)]	13700 (4.02)	14200 (4.16)	14900 (4.37)	24900 (7.30)	32300 (9.47)
	Control of cooling water flow		Automatic by valve				
	Cooling water connection	[NPT-F]	1/2"			3/4"	
	Standard Power Supply (2)	[Ph/V/Hz]	3/460/60				
	Nominal electric consumption	[kW]	0,95	1,10	1,15	2,00	2,20
		[A]	1,7	1,8		2,6	3,2
	Full Load Amperage FLA	[A]	2,2			5,0	6,0
Max. noise level at 1 m	[dbA]	< 70					
Weight	[lb (kg)]	201 (91)	231 (105)	260 (118)	353 (160)	397 (180)	

(1) The nominal condition refers to an ambient temperature of 100°F (38°C) with inlet air at 580 psig (40 barg) and 100°F (38°C).

(2) Check the data shown on the identification plate.

(3) Other temperature on request.

10.4 Technical data DRYPOINT RS 180-550 3phase HP50 NA 3/380/60

MODEL	DP RS HP50 NA	180-F	260-F	350-F	450-F	550-F
Air flow rate at nominal condition (1)	[scfm]	180	260	350	450	550
	[m ³ /h]	306	442	595	765	935
	[l/min]	5097	7362	9911	12743	15575
Pressure DewPoint at nominal condition (1)	[°F (°C)]	38 (3)				
Nominal ambient temperature	[°F (°C)]	100 (38)				
Min...Max ambient temperature	[°F (°C)]	34...122 (1...50)				
Nominal inlet air temperature	[°F (°C)]	100 (38) max.150 (65)				
Nominal inlet air pressure	[psig (barg)]	580 (40)				
Max. inlet air pressure	[psig (barg)]	725 (50)				
Air pressure drop - Δp	[psi (bar)]	2.90 (0.20)	3.19 (0.22)		3.34 (0.23)	3.19 (0.22)
Inlet - Outlet connections	[NPT-F]	1"			1.1/2"	

Air-Cooled	Refrigerant type	R134.a			R407C		
	Refrigerant quantity (2)	[oz (kg)]	31.3/4 (0.90)	34.1/2 (0.98)	51.1/4 (1.45)	63.1/2 (1.80)	68.3/4 (1.95)
	Cooling air fan flow	[cfm (m ³ /h)]	1470 (2500)	1650 (2800)		2100 (3600)	2200 (3700)
	Heat Rejection	[btu/hr (kW)]	13700 (4.02)	14200 (4.16)	14900 (4.37)	24900 (7.30)	32300 (9.47)
	Standard Power Supply (2)	[Ph/V/Hz]	3/380/60				
	Nominal electric consumption	[kW]	1,13	1,28	1,31	2,50	2,75
		[A]	2,2	2,3	2,4	4,7	5,1
	Full Load Amperage FLA	[A]	3,3	3,4		7,7	9,0
	Max. noise level at 1 m	[dbA]	< 70				
	Weight	[lb (kg)]	209 (95)	236 (107)	265 (120)	357 (162)	414 (188)

Water-Cooled	Refrigerant type	R134.a			R407C		
	Refrigerant quantity (2)	[oz (kg)]	28.1/4 (0.80)	31.3/4 (0.90)	45.3/4 (1.30)	56.1/2 (1.60)	63.1/2 (1.80)
	Max. cooling water inlet temp (3)	[°F (°C)]	86 (30)				
	Min...Max. cooling water inlet pressure	[psig (barg)]	45...145 (3...10)				
	Cooling water flow at 15°C	[US gpm (m ³ /h)]	0.48 (0.11)	0.57 (0.13)	0.62 (0.14)	0.84 (0.19)	0.97 (0.22)
	Cooling water flow at 30°C	[US gpm (m ³ /h)]	1.89 (0.43)	2.03 (0.46)	2.33 (0.53)	3.17 (0.72)	3.48 (0.79)
	Heat Rejection	[btu/hr (kW)]	13700 (4.02)	14200 (4.16)	14900 (4.37)	24900 (7.30)	32300 (9.47)
	Control of cooling water flow		Automatic by valve				
	Cooling water connection	[NPT-F]	1/2"			3/4"	
	Standard Power Supply (2)	[Ph/V/Hz]	3/380/60				
	Nominal electric consumption	[kW]	0,95	1,10	1,15	2,00	2,20
		[A]	2,1	2,2		3,1	3,9
	Full Load Amperage FLA	[A]	2,6	2,7		6,1	7,2
Max. noise level at 1 m	[dbA]	< 70					
Weight	[lb (kg)]	201 (91)	231 (105)	260 (118)	353 (160)	397 (180)	

(1) The nominal condition refers to an ambient temperature of 100°F (38°C) with inlet air at 580 psig (40 barg) and 100°F (38°C).

(2) Check the data shown on the identification plate.

(3) Other temperature on request.

11 Technical description

11.1 Control panel

The control panel explained below is the only dryer user interface.

RS 15 – 40

RS 50 – 80

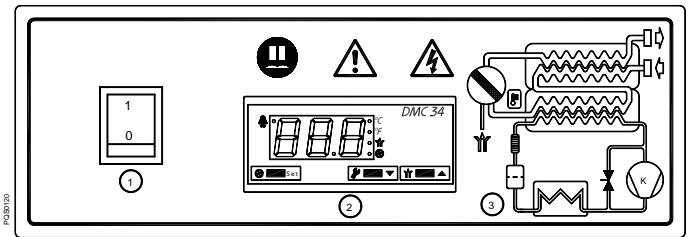
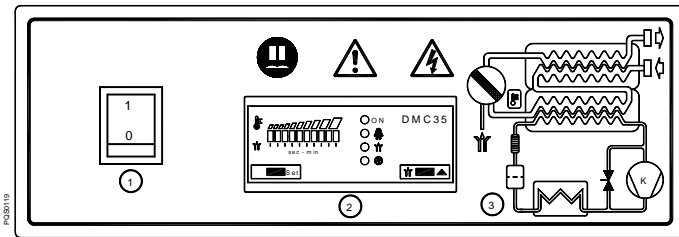

RS 100 – 550

RS 180 – 550 3phase

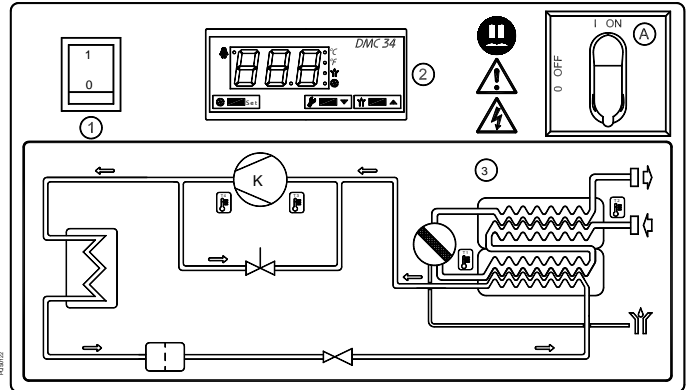
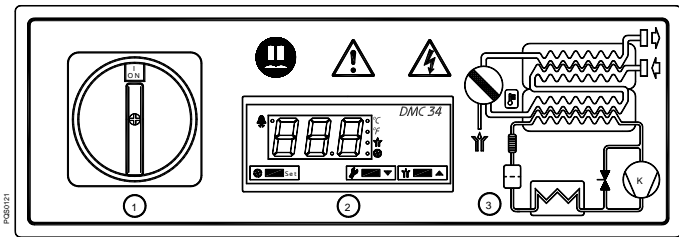

- A Main switch
- 1 Main switch
- 2 Electronic instrument
- 3 Air and refrigerant flow diagram

11.2 Functional description

Operating principle – All dryer models described in this manual function according to the same principle. The hot and moisture-loaded air is led into an air/air heat exchanger. Afterwards, the air flows through an evaporator, which is also known as an air/refrigerant heat exchanger. The air temperature is reduced to approximately +36°F (+2°C), so that water vapour condenses to liquid. The continuously accumulating condensate is collected in the separator to be discharged via the condensate drain. Subsequently, the cold and dry air is led through the air/air heat exchanger, so that it is reheated to up to 8°C below the inlet temperature when leaving the dryer.

Refrigeration cycle – The refrigerant is conducted through the compressor and reaches a condenser under high pressure. There, cooling-down takes place, making the refrigerant condense to a liquid state which is under high pressure. The liquid is pressed through a capillary tube where the resulting pressure drop ensures that the refrigerant evaporates at a defined temperature. The liquid refrigerant which is under low pressure is led into the heat exchanger, where it expands. The cold resulting from the expansion serves to cool down the compressed air in the heat exchanger. During this process, the refrigerant evaporates. The low-pressure gas is resupplied to the compressor, where it is compressed again. It then re-enters the cycle. In phases of a reduced compressed-air load, the excess refrigerant is resupplied automatically to the compressor via the hot gas bypass valve.

11.3 Flow chart (air-cooled)

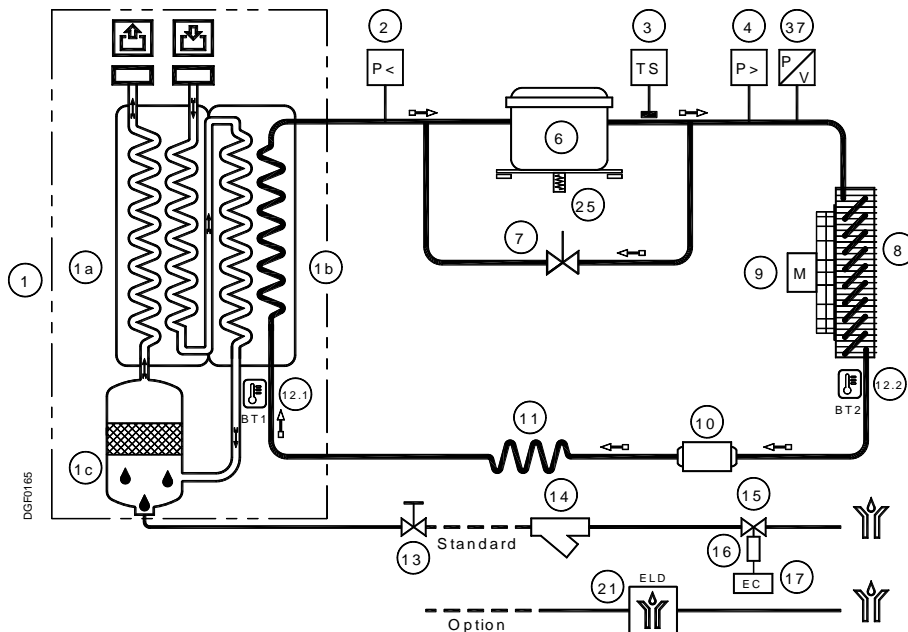

11.4 Flow chart (water-cooled)

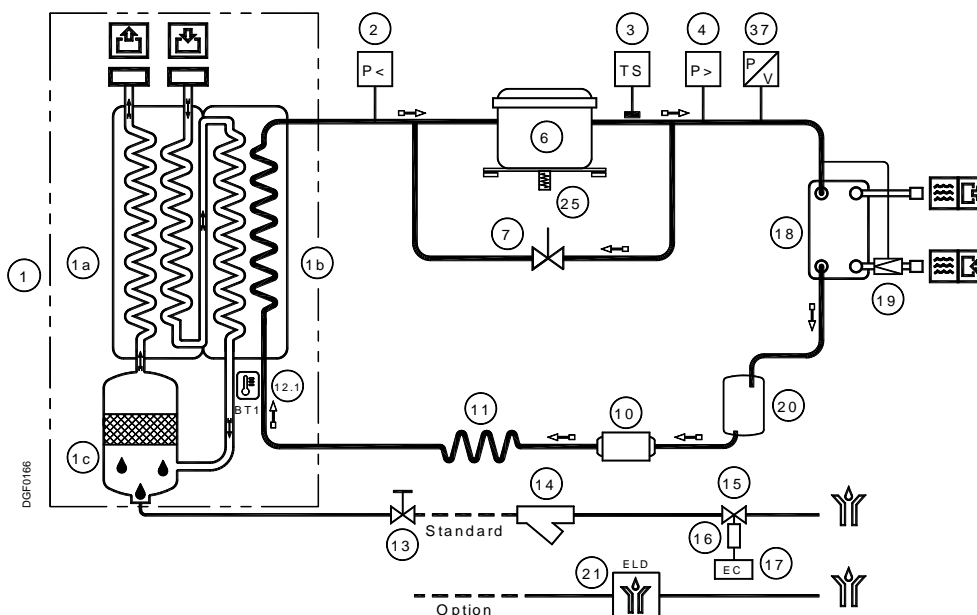

- | | |
|--|---|
| 1 Heat exchanger group | 10 Filter dryer |
| a – Air/air heat exchanger | 11 Capillary tube |
| b – Air/refrigerant heat exchanger | 12.1 T1 temperature sensor (dew point) |
| c – Condensate separator | 12.2 T2 Temperature sensor (fan control) (RS 15-40) |
| 2 Refrigerant pressure switch LPS (P<) | 13 Condensate drain shut-off valve |
| (RS 450-550 & RS 180-550 3phase) | 18 Condenser (water-cooled) |
| 3 Safety temperature switch TS | 19 Cooling-water regulating valve (water-cooled) |
| (RS 100-550 & RS 180-550 3phase) | 20 Liquid collector (water-cooled) |
| 4 Refrigerant pressure switch HPS (P>) | 21 BEKOMAT condensate drain |
| 6 Refrigerating compressor | 25 Compressor crankcase heater (RS 180-550 3phase) |
| 7 Hot-gas bypass valve | 37 Refrigerant transducer BP2 |
| 8 Condenser (air-cooled) | (RS 50-550 & RS 180-550 3phase) |
| 9 Condenser fan (air cooled) | |

➡ Compressed-air flow direction

➡ Refrigerant gas flow direction

Technical description

11.5 Refrigerating compressor

The employed refrigerating compressors are constructed by leading manufacturers. The hermetically sealed construction is absolutely gastight. The integrated safeguard protects the compressor against overheating and excess current. The protection is automatically reset as soon as the nominal conditions are reached again.

11.6 Condenser (air-cooled)

The condenser is the component in which the gas coming from the compressor is cooled down, condensed and liquefied. Under no circumstances must the temperature of the ambient air exceed the nominal values. It is also important that the condenser unit is kept free from dust and other impurities.

11.7 Condenser (water-cooled)

The condenser is the component in which the gas coming from the compressor is cooled-down, condensed and liquefied. The water inlet temperature must not exceed the nominal values. Likewise, a correct flow must be ensured. The water entering the condenser must be free from impurities.

11.8 Cooling-water regulating valve

The cooling-water regulating valve serves to keep the condensation pressure or the condensation temperature constant during water cooling. When the dryer is switched off, the valve automatically blocks the cooling-water flow.

11.9 Filter dryer

Despite controlled vacuuming, traces of moisture can accumulate in the refrigeration cycle. The filter dryer serves to absorb this moisture and to bond it.

11.10 Capillary tube

The capillary tube is a copper tube with a reduced diameter which is located between the condenser and the evaporator, serving as a restrictor to reduce the pressure of the refrigerant. The pressure reduction serves to reach an optimum temperature inside of the evaporator. The lower the outlet pressure at the capillary tube, the lower the evaporation temperature.

The length and the inner diameter of the capillary tube are exactly dimensioned to ensure the performance of the dryer. Settings or maintenance works are not required.

11.11 Air-to-air heat exchanger

The purpose of this exchanger is to drop the heat of the incoming compressed air onto the outgoing cold air. The benefits of this solution are essentially two: the incoming air is already partially cooled so the refrigerating circuit can be sized as to assure a limited thermal heat, with a 40÷50% energy saving. Secondly no cold air is allowed into the compressed air line, thus preventing the system's pipes sweating.

11.12 Air-to-refrigerant heat exchanger

Also called evaporator. The liquid formed in the condenser is evaporated in this part of the circuit. In the evaporation phase the refrigerant tends to absorb the heat from the compressed air present in the other side of the exchanger.

Refrigerant and air are in counter flow, thus contributing to limit pressure drop and to provide efficient thermal exchange.

11.13 Condensate separator

The cold air exiting the evaporator goes through the hi-efficiency condensate separator featuring a stainless steel mesh. As the condensate transported by the air gets in contact with the mesh net it is separated and expelled by means of the draining device. The resulting cold and dry air is then conveyed into the air-to-air heat exchanger.

The mesh type mist separator offers the benefit to be highly efficient even with variable flow rates.

11.14 Hot-gas bypass valve

At partial load, the valve directly returns a part of the hot gas to the suction line of the refrigerating compressor. The evaporation temperature and the evaporation pressure remain constant.

11.15 Refrigerant pressure switches LPS – HPS

To ensure the operational reliability and the protection of the dryer, a series of pressure switches are installed in the gas cycle.

LPS : Low-pressure guard on the suction side of the compressor, which is triggered when the pressure drops below the predetermined value. The values are reset automatically as soon as the nominal conditions are re-established.

HPS : The high-pressure control unit on the discharge side of the compressor is activated when the pressure exceeds the predetermined value. It has a manual reset button on the control itself.

11.16 Safety temperature switch TS

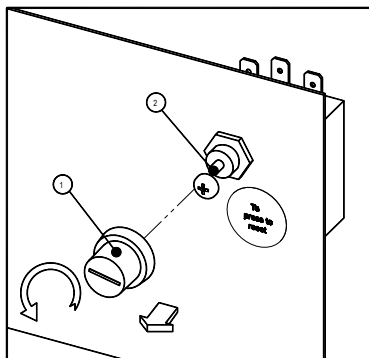

To ensure the operational safety and the soundness of the dryer, a safety temperature switch (TS) is installed at the refrigeration cycle. In the event that the pressure gas temperature is too high, the sensor of the temperature switch will stop the refrigerating compressor to prevent the pressure gas temperature getting too high.

The temperature switch is reset manually, but only when the normal operating conditions are reached again. Unscrew the cover (see pos. 1 in the illustration) and press the reset button (see position 2 in the illustration).

11.17 Compressor crankcase heater (RS 180-550 3phase)

At low temperatures, the oil can more easily intermix with the refrigerant gas. When the compressor starts, oil can be drawn into the refrigeration cycle, leading to "hydraulic shocks".

To prevent this, a resistance heater is installed in the suction side of the compressor. When the system is connected with the electric mains and the compressor is idle, the heater will keep the oil at the correct temperature.

This heater is controlled via a temperature switch which prevents the overheating of the oil.

Note: The heater must be connected to the mains at least a few hours prior to the start-up of the refrigerating compressor.

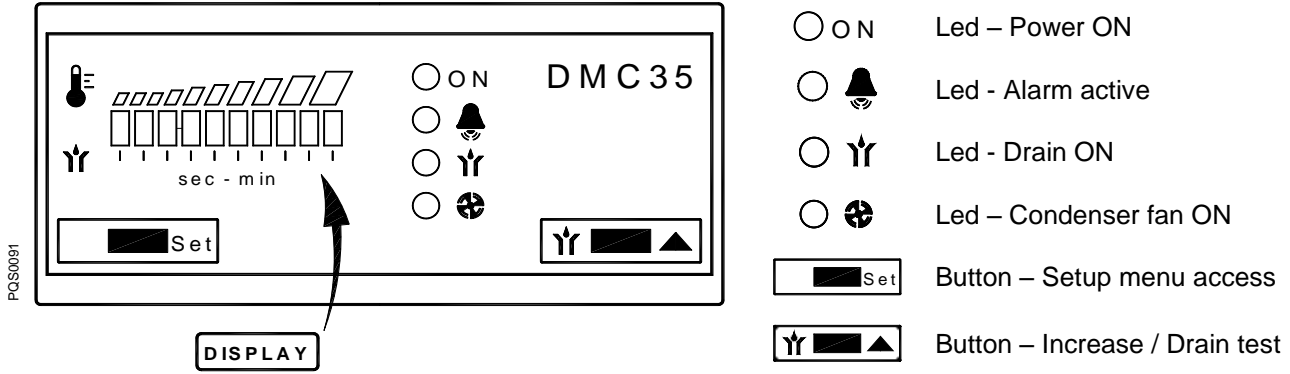

The DMC35 displays DewPoint temperature, controls the condenser fan activation, controls the timed drainer and keep record of the total hours of operation of the dryer.

11.18.1 How to switch on the dryer

Power the dryer and switch it on using the ON-OFF switch (pos.1 paragraph 11.1).

During normal operation led ON is ON and the display shows the DewPoint temperature by means of two coloured areas (green and red) above a 10 Led display :

- Green area - operating conditions ensuring an optimal DewPoint;
- Red area - DewPoint too high, the dryer is operating with high thermal load (high inlet air temperature, high ambient temperature, etc.). Compressed air treatment may be improper.

Led shows that one or more service warnings / alarms are active.

Led shows that condensate drain solenoid valve is ON.

Led shows that condenser fan is ON.

The condensate drain test is always active using the button .

11.18.2 How to switch off the dryer

Switch it off using the ON-OFF switch (pos.1 paragraph 11.1).

11.18.3 How a service warning / alarm is displayed

A service warning / alarm is an unusual event that must recall the attention of the operators/maintenance technicians. It does not stop the dryer.

Service warnings / alarms are automatically reset as soon as the problem is solved and dryer is powered again.

NOTE: the operator/maintenance technician must inspect the dryer and verify/solve the problem that generated the service warning.

Service Warning / Alarm	Description
Led and display 1st (left) and 10th (right) led are flashing	Failure BT1 (DewPoint) temperature probe.
Led and led are flashing	Failure BT2 / BP2 (fan control) probe. NOTE : fan is forced always ON.
Led and display 1st (left) led are flashing	DewPoint too low (lower than -1°C / 30°F).

11.18.4 How is controlled the condenser fan

A temperature probe BT2 is located on the discharge side of the condenser. The condenser fan is activated (ON) when the T2 temperature is higher than FANon setting (approx. 35°C / 96°F) and led  is ON. Condenser fan stops when T2 temperature is lower than FANoff setting (approx. 30°C/86°F).

11.18.5 How is controlled the drain solenoid valve



Drain solenoid valve is activated (ON) for Ton seconds (standard 2 seconds) every Toff minutes (standard 1 minute). Led  shows that condensate drain solenoid valve is ON.

The condensate drain test is always active using the button .



NOTE : if an electronic drainer is installed, DMC35 is set to keep always powered the drain output, Led  is always OFF and condensate drain test does not work.



11.18.6 How to display the total hours of operation

Total hours of operation are recorded into DMC35 and are shown through the dew point indication bar (max value 109900 hours, cannot be reset).

With dryer ON press buttons  and  for at least 5 seconds.

Led  is lit and a certain numbers of leds of dew point indication bar are light up. The number of leds lit define the 1st digit of hour counter (ie : no leds lit → 1st digit =0)

Press  button, led  is lit and a certain numbers of leds of dew point indication bar are light up. The number of leds lit define the 2nd digit of hour counter (ie : n.3 leds lit → 2nd digit = 3)

Press  button, led  is lit and a certain numbers of leds of dew point indication bar are light up. The number of leds lit define the 3rd digit of hour counter (ie : n.8 leds lit → 3rd digit = 8)

Total operating hours : 0 3 8 x 100 (fixed multiplying ratio) = 3800 hours

Press  button repeatedly to scroll the displaying of 3 digits again.

Press  button to exit total hours display (if no button is pressed after 30 seconds the menu is exited automatically).

11.18.7 How to change the operating parameters





The setup menu can be used to change the dryer's operating parameters







Only qualified personnel must be allowed to access to the setup menu. The manufacturer is not responsible for malfunctioning or failure due to modification to the operating parameters.

With dryer ON press button  for at least 2 seconds to enter the setup menu.

Access to the menu is confirmed by led  flashing.

Keep  pressed and use arrows  to change the value. Release the button  to confirm the value. Press shortly  to skip to following parameter.

Press  to exit setup menu (if no button is pressed after 2 minutes the menu is exited automatically).

Display	Description	Limits	Resolution	Standard setup
Synchronous flashing led  + led 	T _{ON} – drain time ON : time ON condensate drain valve (1)	1 ... 6 sec	1 sec	2
Non-synchronous flashing led  + led 	T _{OFF} - drain time OFF : pause time for condensate drain valve	1 ... 10 min	1 min	1

NOTE : parameter values are displayed on the 10 led display where 1st (left) led is the lowest limit and 10th (right) is the highest limit.

NOTE (1) : TON set at the 10th led (right) keep drain output always powered and led  always off (used if electronic drainer is installed)

11.19 Electronic controller DMC34

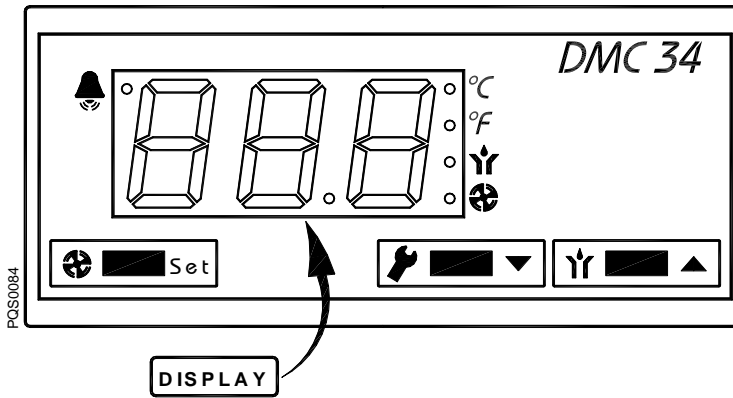

- °C Led - Temperature in °C
- °F Led - Temperature in °F
- Led – Drain ON
- Led – Fan ON
- Led – Alarm/Service
- Button – Setup menu access / Condensing
- Button – Decrease / Service
- Button – Increase / Drain test

The DMC34 displays DewPoint temperature, controls the condenser fan activation, handles a service reminder and keep record of the total hours of operation of the dryer.

11.19.1 How to switch on the dryer

Power the dryer and switch it on using the ON-OFF switch (pos. 1 paragraph 11.1). During normal operation the display shows the DewPoint temperature.

The condensate drain test is always active using the button

11.19.2 How to switch off the dryer

Switch it off using the ON-OFF switch (pos. 1 paragraph 11.1).

11.19.3 How to display the operating parameters

During normal operation, the display shows the DewPoint temperature (in °C or °F).

Press and hold button to display condensing pressure.

Press and hold button to display hours until the next service.

Press and hold + buttons to display total hours of operation of the dryer (cannot be reset).

NOTE : with led °C on temperatures are in °C and pressure in barg; with led °F on temperatures are in °F and pressure in psig.
The total hours of operation and the hours until the next service are shown in the field 0...999 hours and in thousands of hours from 01.0 hours on (example : if the display shows number 35 it means 35 hours; if the display shows number 3.5 it means 3500 hours).

11.19.4 How a service warning / alarm is displayed

A service warning / alarm is an unusual event that must recall the attention of the operators/maintenance technicians. It does not stop the dryer.

When a service warning / alarm is active, the led is lighted or flashing.

Service warnings / alarms are automatically reset as soon as the problem is solved and dryer is powered again. Scheduled Service reminder requires manual reset.

NOTE: the operator/maintenance technician must inspect the dryer and verify/solve the problem that generated the service warning.

Service Warning / Alarm	Description
flashing + PF 1 on display	PF1 - Probe 1 Failure : failure temperature probe BT1
flashing + PF 2 on display	PF2 - Probe 2 Failure : failure pressure probe BP2
flashing + HdP on display	HdP - High DewPoint: DewPoint too high Set BT1>HdS, delay Hdd / Reset BT1<HdS-1°C (HdS-2°F)
flashing + LdP on display	LdP - Low DewPoint : DewPoint too low Set BT1< -1°C (30°F), delay 5 minutes / Reset T1> 1°C (34°F)
flashing + SrV on display	SrV - Service : maintenance service time expired SrV

11.19.5 How is controlled the condenser fan

A pressure probe BP2 is located on the discharge side of the compressor. The condenser fan is activated (ON) when the BP2 pressure is higher than FANon setting (R134a approx. 11 barg/160 psig – R407C approx. 18 barg/260 psig) and led  is ON. Condenser fan stops when BP2 pressure is lower than FANoff setting (R134a approx. 8 barg/115 psig – R407C approx. 14 barg/203 psig).



11.19.6 How is controlled the drain solenoid valve

Drain solenoid valve is activated (ON) for *t_{on}* seconds (standard 2 seconds) every *t_{oF}* minutes (standard 1 minute). Led  shows that condensate drain solenoid valve is ON.

The condensate drain test is always active using the button .

NOTE : if an electronic drainer is installed, DMC34 is set to keep always powered the drain output (*t_{on}* = ON).

11.19.7 How to reset the service reminder timer



With dryer OFF keep pressed buttons  + , power the dryer and switch it on using the ON-OFF switch (pos.1 paragraph 7.1).



After 5 seconds display shows *SrL*, release buttons  + , keep pressed button  for 5 seconds. Timer has been reset and controller start to operate regularly.

Service reminder timing can be reset at any time, even before the timing has expired.

11.19.8 Operation of the failure / alarm dry contact

The DMC34 is equipped with a dry contact (potential free) to display failure and/or alarm conditions.

  Dryer powered and no service warning / alarm is active.



  Dryer not powered or service warning / alarm is active.





11.19.9 How to change the operating parameters



The setup menu can be used to change the dryer's operating parameters.



Only qualified personnel must be allowed to access to the setup menu. The manufacturer is not responsible for malfunctioning or failure due to modification to the operating parameters.

With dryer ON simultaneously press buttons  +  for at least 5 seconds to enter the setup menu. Access to the menu is confirmed by message *t_{on}* on the display (first parameter of menu).

Keep  pressed to display the value of the selected parameter and use arrows  and  to change the value. Release the button  to confirm the value and skip to following parameter.

Press  +  to exit setup menu (if no button is pressed after 2 minutes the menu is exited automatically).

ID	Description	Limits	Resolution	Standard setup
<i>t_{on}</i>	Ton – drain time ON : time ON condensate drain valve ON = Electronic drainer installed	ON 00 ... 20 sec	1 sec	2
<i>t_{oF}</i>	ToF - drain time OFF : pause time for condensate drain valve	1 ... 20 min	1 min	1
<i>HdS</i>	HdS – High DewPoint Setting : Alarm threshold for a high DewPoint (the alarm disappears when the temperature drop 1°C / 2°F below alarm point)	0.0...25.0 °C or 32 ... 77 °F	0.5 °C or 1 °F	20 or 68
<i>Hdd</i>	Hdd - High DewPoint Delay : high DewPoint alarm enable delay	01 ... 20 minutes	1 min	15
<i>SrL</i>	SrV - Service Setting: setting of service warning timer. 00 = service warning timer disabled.	00.0 ... 20.0 (x 1000) hours	0.5 (x1000) hours	08.0
<i>SrC</i>	SrC – Service Contact : configuration of the alarm dry contact for the service warning timer. YES = activate the contact / NO = NOT activate the contact	YES / NO	-	YES
<i>SCL</i>	SCL - Scale: display scale of temperatures and pressure (°C = temperatures in °C and pressure in barg; °F = temperatures in °F and pressure in psig)	°C ... °F	-	°C

11.20 Electronically level-controlled BEKOMAT condensate drain

The electronically level-controlled BEKOMAT condensate drain boasts a special condensate management which ensures that condensate is discharged safely and without an unnecessary loss of compressed air. This drain has a condensate collection container in which a capacitive sensor continuously monitors the liquid level. As soon as the switching level is reached, the capacitive sensor transmits a signal to the electronic control and a membrane solenoid valve opens to discharge the condensate. The BEKOMAT closes before compressed air emerges.



Note!

These BEKOMAT condensate drains were designed in particular for the operation in a **DRYPOINT RS HP50 NA** refrigeration dryer. The installation in other compressed-air processing systems or the replacement with another drain brand can lead to malfunction. The maximum operating pressure (see name plate) must not be exceeded!

Ensure that the upstream valve is open when the dryer starts operation.

To obtain detailed information regarding drain functions, troubleshooting, maintenance and spare parts, please read the installation and operating instructions of the BEKOMAT condensate drain.

12 Maintenance, troubleshooting, spare parts and dismantling

12.1 Checks and maintenance



Certified skilled personnel

Installation works must exclusively be carried out by authorised and qualified skilled personnel. Prior to undertaking any measures on the DRYPOINT® RS 15-550 HP50 NA high pressure compressed-air refrigeration dryer, the certified skilled personnel⁴ shall read up on the device by carefully studying the operating instructions. The operator is responsible for the adherence to these provisions. The respective directives in force apply to the qualification and expertise of the certified skilled personnel.

For safe operation, the device must only be installed and operated in accordance with the indications in the operating instructions. In addition, the national and operational statutory provisions and safety regulations, as well as the accident prevention regulations required for the respective case of application, need to be observed during employment. This applies accordingly when accessories are used.



Danger!

Compressed air!

Risk of serious injury or death through contact with quickly or suddenly escaping compressed air or through bursting and/or unsecured plant components.

Compressed air is a highly dangerous energy source.

Never work on the dryer when the system is under pressure.

Never direct the compressed-air outlet or condensate drain hoses at persons.

The user is responsible for the proper maintenance of the dryer. Non-observance of the instructions in the "Installation" and "Maintenance, troubleshooting, spare parts and dismantling" chapters leads to the expiration of the guarantee. Improper maintenance may result in dangerous situations for the personnel and/or the device.



Danger!

Supply voltage!

Contact with non-insulated parts carrying supply voltage involves the risk of an electric shock resulting in injuries and death.

Only qualified and skilled personnel are authorised to run electrically-operated devices. Prior to undertaking maintenance measures at the device, the following requirements must be met:

Make sure that the power supply is switched off and that the device is off and marked for maintenance measures. Please also ensure that the power supply cannot be re-established during the works.



Prior to carrying out maintenance works at the dryer, switch it off and wait for at least 30 minutes.



Caution!

Hot surfaces!

During operation, several components can reach surface temperatures of more than +140°F (+60°C). There is the risk of burns.

All components concerned are installed inside of the closed housing. The housing must only be opened by certified skilled personnel.

Some components can reach high temperatures during operation. Avoid any contact until the system or the component has cooled down.

⁴ Certified skilled personnel are persons who are authorised by the manufacturer, with experience and technical training, who are well-grounded in the respective provisions and laws and capable of carrying out the required works and of identifying and avoiding any risks during the machine transport, installation, operation and maintenance. Qualified and authorised operators are persons who are instructed by the manufacturer regarding the handling of the refrigeration system, with experience and technical training, and who are well-grounded in the respective provisions and laws.



DAILY:

- Check whether the dew point indicated on the electronics is correct.
- Ensure that the condensate drain system functions properly.
- Make sure that the condenser is clean.

EVERY 200 HOURS OR MONTHLY



- Clean the condenser using an air jet (max. 2 bar / 30 psig) inside out. Make sure not to damage the aluminium lamellae of the cooling package.
- Finally, verify the operation of the device.

EVERY 1,000 HOURS OR ANNUALLY



- Verify all screws, clamps and connections of the electric system to make sure that they are fastened securely. Check the device for broken and ruptured cables or cables without insulation.
- Check the refrigeration cycle for signs of oil and refrigerant leaks.
- Measure the current strength and note it down. Ensure that the read values are within the permissible limit values, as indicated in the specification table.
- Check the hose lines of the condensate drain and replace them, if required.
- Finally, verify the operation of the device.



EVERY YEAR

- Clean housing and valve of BEKOMAT
- Replace BEKOMAT wearing parts

12.2 Troubleshooting



Certified skilled personnel

Installation works must exclusively be carried out by authorised and qualified skilled personnel. Prior to undertaking any measures on the DRYPOINT® RS 15-550 HP50 NA high pressure compressed-air refrigeration dryer, the certified skilled personnel shall read up on the device by carefully studying the operating instructions. The operator is responsible for the adherence to these provisions. The respective directives in force apply to the qualification and expertise of the certified skilled personnel.

For safe operation, the device must only be installed and operated in accordance with the indications in the operating instructions. In addition, the national and operational statutory provisions and safety regulations, as well as the accident prevention regulations required for the respective case of application, need to be observed during employment. This applies accordingly when accessories are used.



Danger!

Compressed air!

Risk of serious injury or death through contact with quickly or suddenly escaping compressed air or through bursting and/or unsecured plant components.

Compressed air is a highly dangerous energy source.

Never work on the dryer when the system is under pressure.

Never direct the compressed-air outlet or condensate drain hoses at persons.

The user is responsible for the proper maintenance of the dryer. Non-observance of the instructions in the "Installation" and "Maintenance, troubleshooting, spare parts and dismantling" chapters leads to the expiration of the guarantee. Improper maintenance may result in dangerous situations for the personnel and/or the device.



Danger!

Supply voltage!

Contact with non-insulated parts carrying supply voltage involves the risk of an electric shock resulting in injuries and death.

Only qualified and skilled personnel are authorised to run electrically-operated devices. Prior to undertaking maintenance measures at the device, the following requirements must be met:

Make sure that the power supply is switched off and that the device is off and marked for maintenance measures. Please also ensure that the power supply cannot be re-established during the works.



Prior to carrying out maintenance works at the dryer, switch it off and wait for at least 30 minutes.



Caution!
Hot surfaces!



During operation, several components can reach surface temperatures of more than +140°F (+60°C). There is the risk of burns.

All components concerned are installed inside of the closed housing. The housing must only be opened by certified skilled personnel.

Some components can reach high temperatures during operation. Avoid any contact until the system or the component has cooled down.

FAULT	POSSIBLE REASON – SUGGESTED MEASURE
◆ The dryer does not start.	<ul style="list-style-type: none"> ⇒ Check whether or not the dryer is connected with the electric mains. ⇒ Check the electric cabling. ⇒ RS 180-550 3phase- Blow of fuse (FU3 on the electric diagram) of the auxiliary circuit - replace it and check the proper operation of the dryer.
◆ The refrigerating compressor does not work.	<ul style="list-style-type: none"> ⇒ The internal heat protection of the compressor was activated – wait 30 minutes and then retry. ⇒ Check the electric cabling. ⇒ If installed – replace the internal heat protection and/or the start-up relay and/or the starting capacitor and/or the operating capacitor. ⇒ HPS pressure switch was activated – see the corresponding point. ⇒ If installed – the LPS pressure switch was activated – see the corresponding point. ⇒ If installed – the TS safety temperature switch was activated – see the corresponding point. ⇒ In the event that the compressor still does not work, replace it.
◆ The fan of the condenser does not work (air-cooled).	<ul style="list-style-type: none"> ⇒ Check the electric cabling. ⇒ The electronic control unit is faulty – replace it ⇒ If installed - Fan relay / power contactor (see KF / KV1 on the electric diagram) is faulty - replace it. ⇒ RS 180-550 3phase- Blow of fuse (FU1 on the electric diagram) - replace it and check the proper operation of the dryer. ⇒ There is a leak in the refrigeration cycle – contact a BEKO service technician. ⇒ In the event that the fan still does not work, replace it.
◆ Dew point too high.	<ul style="list-style-type: none"> ⇒ The dryer does not start up – see the corresponding point. ⇒ The BT1 dew point sensor does not record the temperature properly – ensure that the sensor is pushed down to the bottom of the aluminium tube immersion sleeve. ⇒ The refrigerating compressor does not work – see the corresponding point. ⇒ The ambient temperature is too high or the room ventilation insufficient – ensure sufficient ventilation (air-cooled). ⇒ The inlet air is too hot – re-establish the nominal conditions. ⇒ The inlet air pressure is too low – re-establish the nominal conditions. ⇒ The inlet air throughput is higher than the throughput of the dryer – reduce the flow rate - re-establish the nominal conditions. ⇒ The condenser is dirty – please clean it (air-cooled). ⇒ The condenser fan does not work – see the corresponding point (air-cooled). ⇒ The cooling-water flow is insufficient – re-establish the nominal conditions (water-cooled). ⇒ The dryer does not discharge the condensate – see the corresponding point. ⇒ The hot-gas bypass valve needs to be re-adjusted – contact a BEKO service technician to have the nominal setting re-established. ⇒ There is a leak in the refrigeration cycle – contact a BEKO service technician.
◆ Dew point too low.	<ul style="list-style-type: none"> ⇒ RS 15-40 The fan is always ON - Led and led are flashing - see specific point. ⇒ RS 50-550 - The fan is always ON – Led is flashing + display PF2 - see specific point (Air-Cooled). ⇒ The ambient temperature is too low –re-establish the nominal conditions. ⇒ The hot-gas bypass valve needs to be re-adjusted – contact a BEKO service technician to have the nominal setting re-established.
◆ Extreme pressure drop in the dryer.	<ul style="list-style-type: none"> ⇒ The dryer does not discharge the condensate – see the corresponding point. ⇒ The dew point is too low – the condensate is frozen and blocks the air – see the corresponding point. ⇒ Check the flexible connection hoses for obstructions.

Maintenance, troubleshooting, spare parts and dismantling

◆ The dryer does not drain the condensate.	<ul style="list-style-type: none"> ⇒ The shut-off valve at the condensate outlet is closed – open it. ⇒ Check the electric cabling. ⇒ The dew point is too low – the condensate is frozen – see the corresponding point. ⇒ The BEKOMAT condensate drain does not work properly (see BEKOMAT MANUAL).
◆ Failure during the condensate discharge.	<ul style="list-style-type: none"> ⇒ Please read the separate BEKOMAT installation and operating instructions.
◆ Water in the line.	<ul style="list-style-type: none"> ⇒ The dryer does not start – see the corresponding point. ⇒ If installed - untreated air flows through the bypass unit – close the bypass. ⇒ The dryer does not drain condensate – see the corresponding point. ⇒ Dew point too high – see the corresponding point.
◆ HPS high-pressure switch has triggered.	<ul style="list-style-type: none"> ⇒ Check which of the following reasons is responsible for the triggering: <ol style="list-style-type: none"> 1. The ambient temperature is too high or the room ventilation insufficient – ensure sufficient ventilation (air-cooled). 2. The condenser is dirty – please clean it (air-cooled). 3. The condenser fan does not work – see the corresponding point (air-cooled). 4. The cooling water is too hot – re-establish the nominal conditions (water-cooled). 5. The cooling-water flow is insufficient – re-establish the nominal conditions (water-cooled). ⇒ Reset the pressure switch by pressing the button on the controller itself – check the proper functioning of the dryer. ⇒ The HPS pressure switch is defective – contact a BEKO service technician for the replacement.
◆ If installed: the LPS low-pressure switch was triggered.	<ul style="list-style-type: none"> ⇒ There is a leak in the refrigeration cycle – please contact a BEKO service technician. ⇒ The pressure switch is automatically reset as soon as the normal conditions are re-established – check the dryer for proper functioning.
◆ If installed: the TS safety temperature switch was triggered.	<ul style="list-style-type: none"> ⇒ Check which of the following reasons is responsible for the triggering: <ul style="list-style-type: none"> Excess thermal load – re-establish the standard operating conditions. The inlet air is too hot – re-establish the nominal conditions. The ambient temperature is too high or the room ventilation insufficient – ensure sufficient ventilation. The condenser unit is dirty – please clean it. The fan does not work – see the corresponding point. The hot-gas bypass valve needs to be re-adjusted – contact a specialist for refrigerating plants to have the nominal calibration re-established. The cooling-water temperature is too low – re-establish the nominal conditions (water-cooled). The adjusting valve for the cooling-water flow needs to be re-adjusted – contact a specialist to have the nominal calibration re-established (water-cooled). There is a leak in the refrigeration cycle – please contact a BEKO service technician. ⇒ Reset the temperature switch by manually pushing the button on the temperature switch – check the perfect functioning of the dryer. ⇒ The TS temperature switch is defective – replace it.
◆ DMC35 – Led  and display 1st (left) and 10th (right) led are flashing.	<ul style="list-style-type: none"> ⇒ Verify the electric wiring of BT1 DewPoint probe. ⇒ The BT1 DewPoint probe is faulty - replace it. ⇒ The electronic controller is faulty - replace it.
◆ DMC35 – Leds  and  are flashing	<ul style="list-style-type: none"> ⇒ Verify the electric wiring of BT2 / BP2 fan control probe. ⇒ The BT2 / BP2 fan control probe is faulty - replace it. ⇒ The electronic controller is faulty - replace it.
◆ DMC35 Led  and display 1st (left) led are flashing	<ul style="list-style-type: none"> ⇒ DewPoint too low - see specific point. ⇒ The BT1 DewPoint probe is faulty - replace it. ⇒ The electronic controller is faulty - replace it.
◆ DMC35 ◆ The last led of the display is flashing	<ul style="list-style-type: none"> ⇒ DewPoint too high - see specific point. ⇒ The BT1 DewPoint probe is faulty - replace it. ⇒ The electronic controller is faulty - replace it.

<p>◆ DMC34 – Led ○ 🔔 is flashing + display PF1.</p>	<p>⇒ Verify the electric wiring of BT1 DewPoint probe. ⇒ The BT1 DewPoint probe is faulty - replace it. ⇒ The electronic controller is faulty - replace it.</p>
<p>◆ DMC34 – Led ○ 🔔 is flashing + display PF2.</p>	<p>⇒ Verify the electric wiring of BP2 fan control probe. ⇒ The BP2 fan control probe is faulty - replace it. ⇒ The electronic controller is faulty - replace it.</p>
<p>◆ DMC34 – Led ○ 🔔 is flashing + display HdP.</p>	<p>⇒ DewPoint too high - see specific point. ⇒ The BT1 DewPoint probe is faulty - replace it. ⇒ The electronic controller is faulty - replace it.</p>
<p>◆ DMC34 – Led ○ 🔔 is flashing + display LdP.</p>	<p>⇒ DewPoint too low - see specific point. ⇒ The BT1 DewPoint probe is faulty - replace it. ⇒ The electronic controller is faulty - replace it.</p>
<p>◆ DMC34 – Led ○ 🔔 is flashing + display SrL.</p>	<p>⇒ Service reminder timer has expired – dryer requires service. ⇒ Perform the proper service to the dryer. ⇒ Reset the service reminder timer.</p>

12.4 Recommended spare parts

Spare parts list is printed on a dedicated sticker applied inside the dryer. On this sticker each spare part is identified with its ID Number and related Spare Part Number. Here below the cross reference table between ID Numbers and exploded drawings Ref. with their description and quantity installed in the dryers.

NOTE: To order the recommended spare parts or other elements, the data on the name plate must be indicated.

ID N.	DESCRIPTION	DP RS NA HP 45 - HP 50												
		15	30	40	50	80	100	140	180	260	350	450	550	
2	LPS	Pressure switch											1	1
3	TS	Safety thermo switch											1	1
4	HPS	Pressure switch	1	1	1	1	1	1	1	1	1	1	1	1
37		Pressure transducer				1	1	1	1	1	1	1	1	1
6	MC	Compressor	1	1	1	1	1	1	1	1	1	1	1	1
7		Hot gas by-pass valve	1	1	1	1	1	1	1	1	1	1	1	1
8		Condenser	1	1	1	1	1	1	1	1	1	1	1	1
9	MV	Complete fan											1	1
9.1	MV	Fan motor	1	1	1	1	1	1	1	1	1			
9.2		Fan blade	1	1	1	1	1	1	1	1	1			
9.3		Fan grid		1	1	1	1	1	1	1	1			
10		Filter drier	1	1	1	1	1	1	1	1	1	1	1	1
12	BT	Temperature probe	2	2	2	1	1	1	1	1	1	1	1	1
13		Condensate drain valve/strainer	1	1	1	1	1	1	1	1	1	1	1	1
15	EVD	Condensate drain solenoid valve	1	1	1	1	1	1	1	1	1	1	1	1
16		Coil for condensate drain solenoid valve	1	1	1	1	1	1	1	1	1	1	1	1
17	DMC35	Electronic instrument	1	1	1									
	DMC34					1	1	1	1	1	1	1	1	1
19		Water regulating valve (water cooled)											1	1
21	ELD	Electronic drainer	1	1	1	1	1	1	1	1	1	1	1	1
		Service unit for electronic drainer	1	1	1	1	1	1	1	1	1	1	1	1
22	S1	Lighted switch	1	1	1	1	1	1	1					
	QS	Main switch											1	1
	KF	Solid State Relay											1	1

ID N.	DESCRIPTION	DP RS NA HP50 -R & -F					
		180	260	350	450	550	
2	LPS	Pressure switch	1	1	1	1	1
3	TS	Safety thermo switch	1	1	1	1	1
4	HPS	Pressure switch	1	1	1	1	1
37		Pressure transducer	1	1	1	1	1
6	MC	Compressor	1	1	1	1	1
7		Hot gas by-pass valve	1	1	1	1	1
8		Condenser	1	1	1	1	1
9	MV	Complete fan	1	1	1	1	1
10		Filter drier	1	1	1	1	1
12	BT	Temperature probe	1	1	1	1	1
14		Y strainer	1	1	1	1	1
15	EVD	Condensate drain solenoid valve	1	1	1	1	1
16		Coil for condensate drain solenoid valve	1	1	1	1	1
17	DMC34	Electronic instrument	1	1	1	1	1
19		Water regulating valve (water cooled)	1	1	1	1	1
21	ELD	Electronic drainer	1	1	1	1	1
		Service unit for electronic drainer	1	1	1	1	1
22	S1	Lighted switch	1	1	1	1	1
	QS	Main switch	1	1	1	1	1
60	FU	Fuse kit	1	1	1	1	1
	KC1-KV1	Contactora	2	2	2	2	2
	TF	Transformer	1	1	1	1	1

12.5 Maintenance works at the refrigeration cycle



Caution! Refrigerant!

Maintenance and repair works at refrigeration systems must only be carried out by BEKO service technicians in accordance with the local provisions.

The total amount of refrigerant in the system must be collected for recycling purposes, resource recovery or disposal.

The refrigerant must not be discharged into the environment.

When delivered, the dryer is ready to operate and filled with a refrigerant of the R134a or R407C type.



Should you detect a refrigerant leak, please contact a BEKO service technician. Prior to any intervention, the room needs to be ventilated.

When the refrigeration cycle needs to be refilled, please also contact a BEKO service technician.

You will find the refrigerant type and amount on the name plate of the dryer.

Properties of the refrigerants used:

Refrigerant	Chemical formula	MIK	GWP
R134a - HFC	CH ₂ FCF ₃	1000 ppm	1430
R407C - HFC	R32/125/134a (23/25/52) CHF ₂ CF ₃ /CH ₂ F ₂ /CH ₂ FCF ₃	1000 ppm	1773.85

12.6 Dismantling the dryer

When the dryer is dismantled, all parts and operating materials related to the plant need to be disposed of separately.



Part	Material
Refrigerant fluid	R407C, R134a, Oil
Canopy and supports	Carbon steel, Epoxy paint
Refrigerating compressor	Steel, Copper, Aluminium, Oil
Heat exchanger	Stainless steel, Copper
Condensate separator	Stainless steel
Condenser unit	Aluminium, Copper, Carbon steel
Pipe	Copper
Fan	Aluminium, Copper, Steel
Valve	Brass, Steel
Electronic level drain	PVC, Aluminium, Steel
Insulation material	Synthetic rubber without CFC, Polystyrene, Polyurethane
Electric cable	Copper, PVC
Electric parts	PVC, Copper, Brass



We recommend observing the safety provisions in force for the disposal of each material type.

The refrigerant contains lubricating-oil droplets which are released by the compressor.

The refrigerant must not be discharged into the environment. It must be sucked off from the dryer using a suitable device, and then needs to be supplied to a collection point.

13.1.2 Dryer dimensions DRYPOINT RS 50-80 HP50 NA

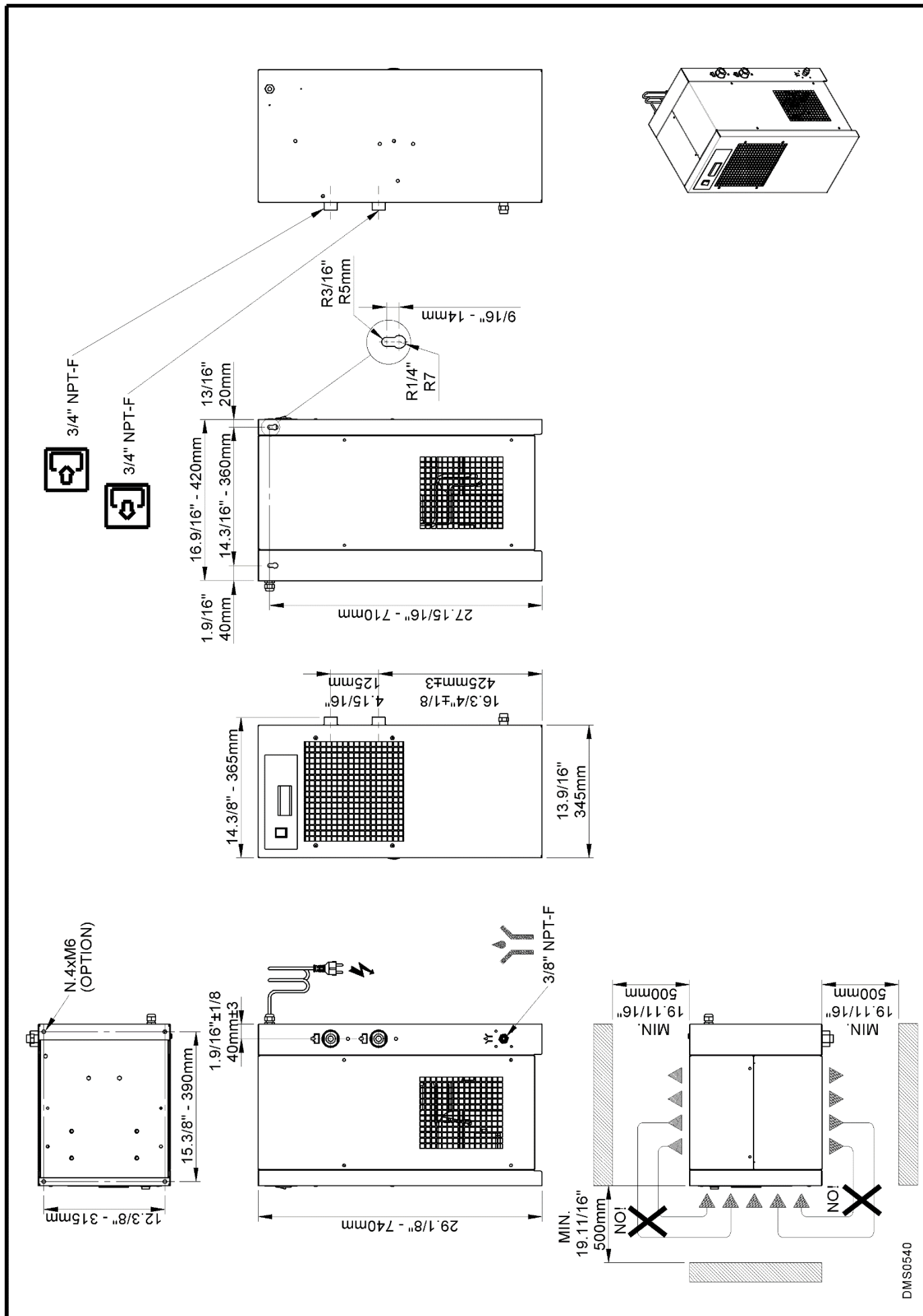

13.1.3 Dryer dimensions DRYPOINT RS 100-140 HP50 NA

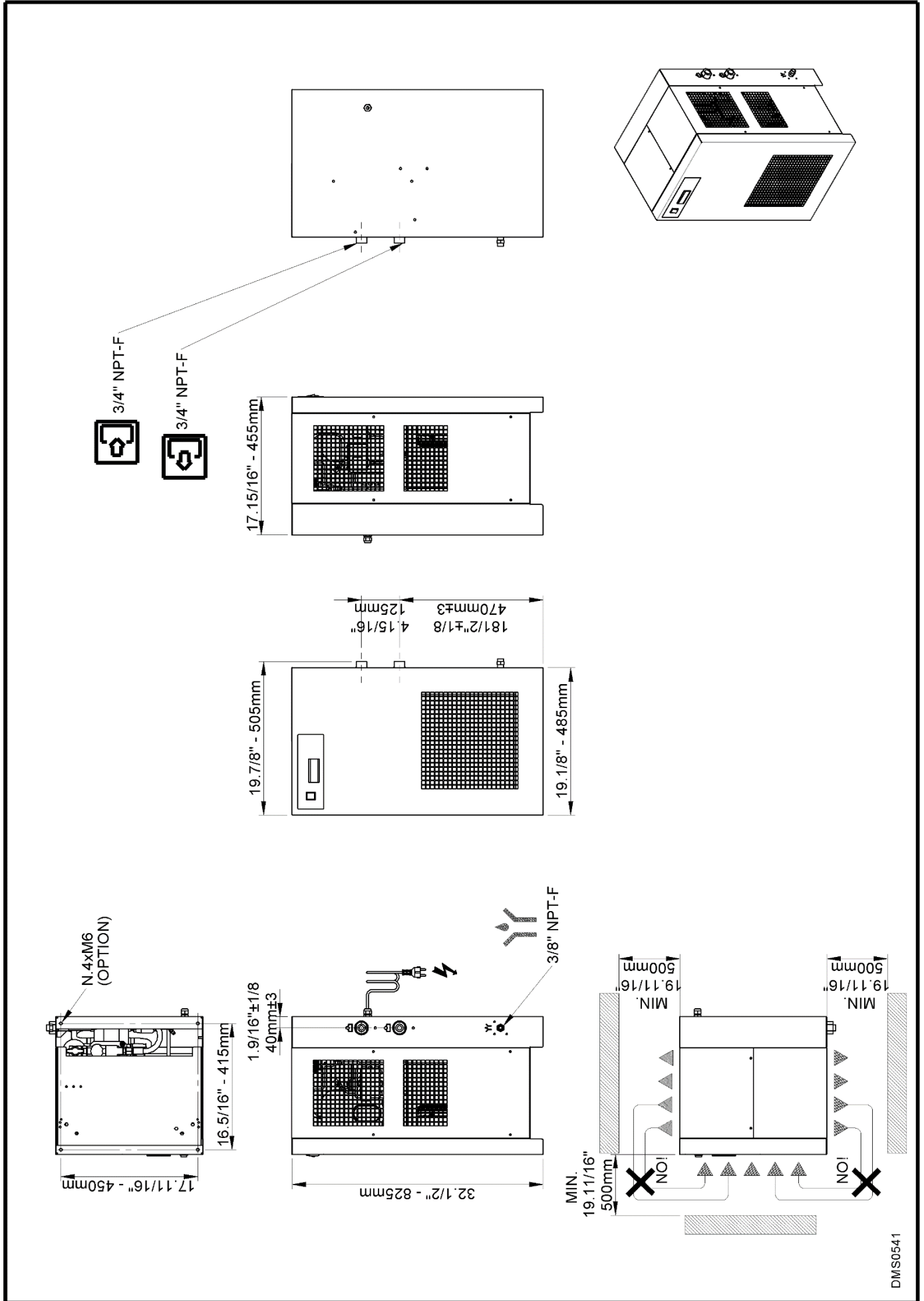

DMS0541

13.1.4 Dryer dimensions DRYPOINT RS 180-350 HP50 NA

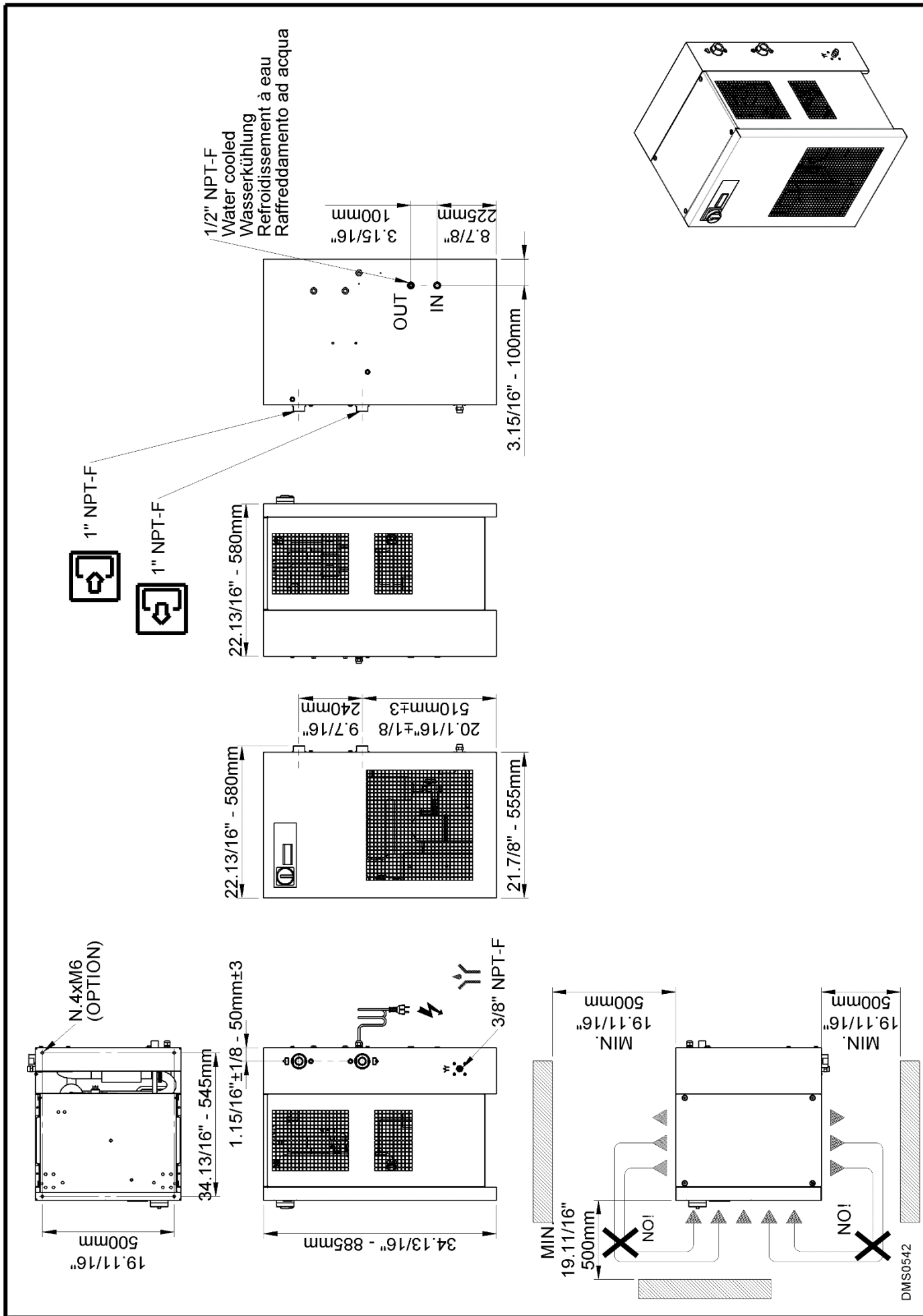

13.1.5 Dryer dimensions DRYPOINT RS 450-550 HP50 NA

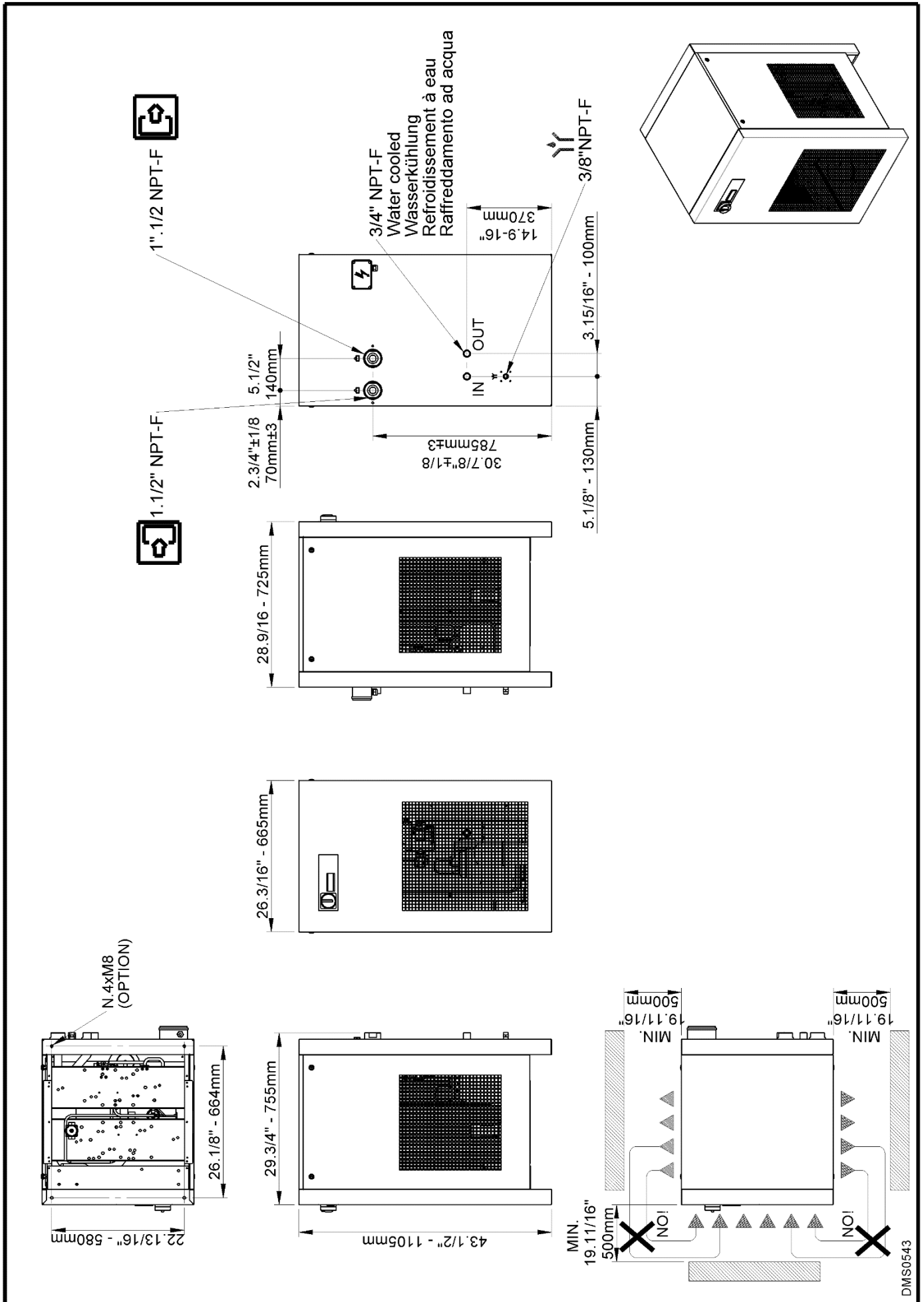

13.1.6 Dryer dimensions DRYPOINT RS 180-350 HP50 NA 3phase

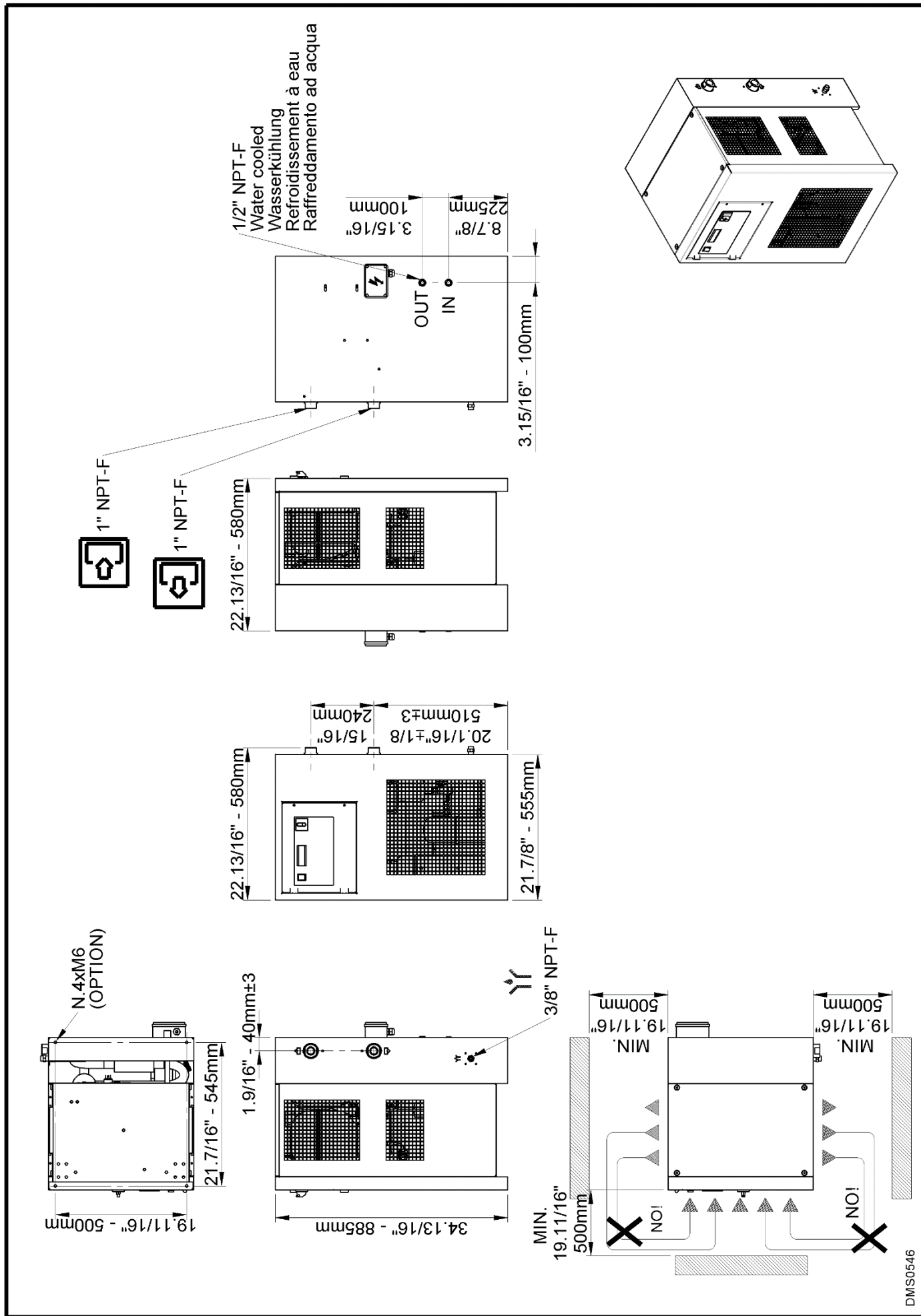

13.1.7 Dryer dimensions DRYPOINT RS 450-550 HP50 NA 3phase

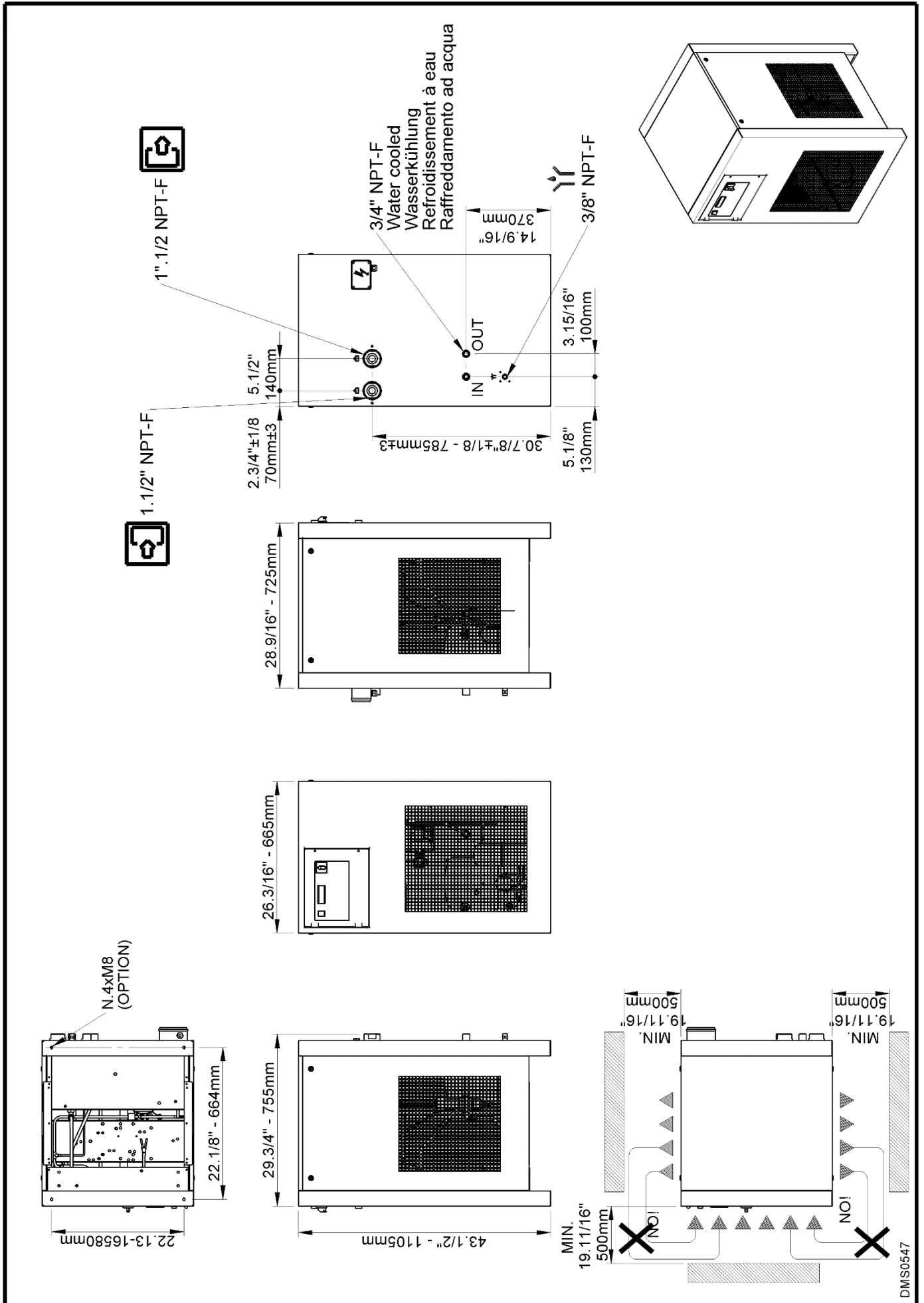

13.2 Exploded diagrams

13.2.1 Components of the exploded diagrams

1 Heat exchanger group	20 Refrigerant reservoir (water-cooled)
c – Condensate separator	21 Bekomat drain
2 Refrigerant pressure switch LPS	22 Main switch
3 Safety temperature switch TS	...
4 Refrigerant pressure switch HPS	51 Front panel
5 Refrigerant fan pressure switch PV	52 Back plate
6 Compressor	53 Right sidewall
7 Hot-gas bypass valve	54 Left sidewall
8 Condenser (air-cooled)	55 Cover
9 Condenser fan	56 Base plate
9.1 Motor	57 Upper plate
9.2 Blade	58 Carrier support
9.3 Grid	59 Support bracket
10 Filter dryer	60 Control panel
11 Capillary tube	61 Electric connecting plug
12 T1 temperature probe (dew point)	62 Electric cabinet
13 Condensate drain service valve	65 Condenser filter
17 Air dryer control	66 QE door
18 Condenser (water-cooled)	81 Adhesive label flow chart
19 Condenser water-regulating valve (water-cooled)	100 Autotransformer

13.2.2 Exploded diagram DRYPOINT RS 15-40 HP50 NA

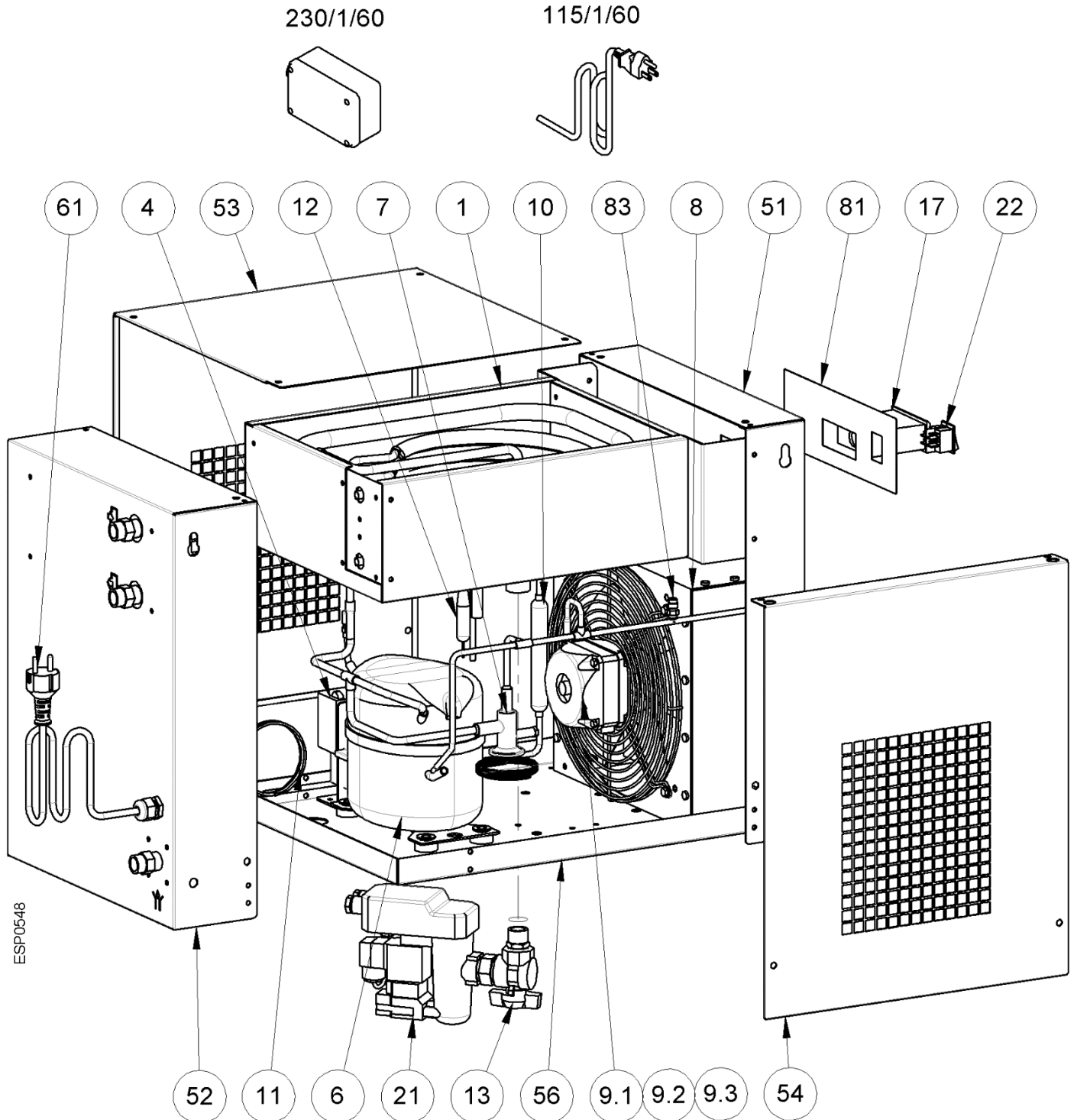

13.2.3 Exploded diagram DRYPOINT RS 50-80 HP50 NA

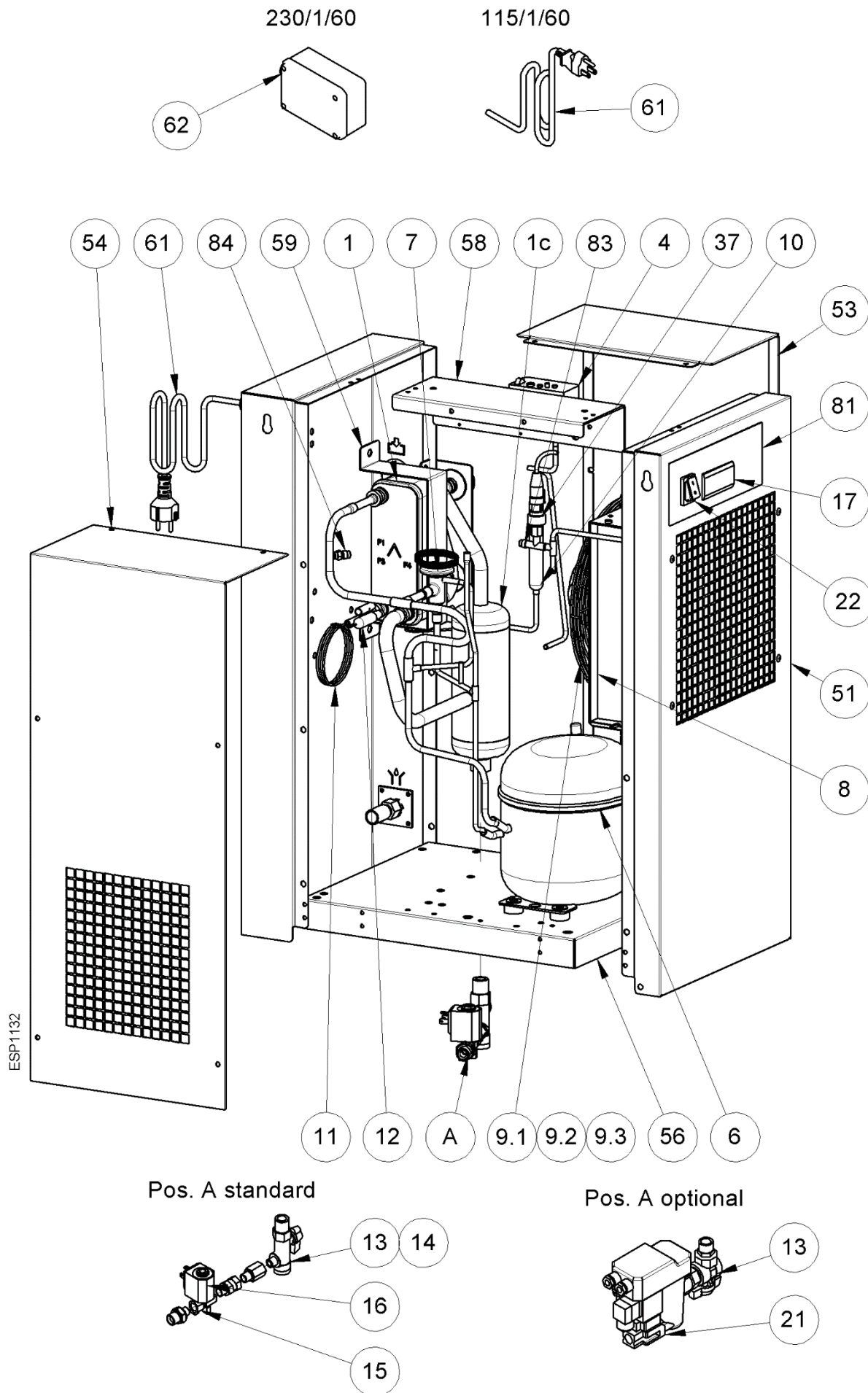

13.2.4 Exploded diagram DRYPOINT RS 100-140 HP50 NA

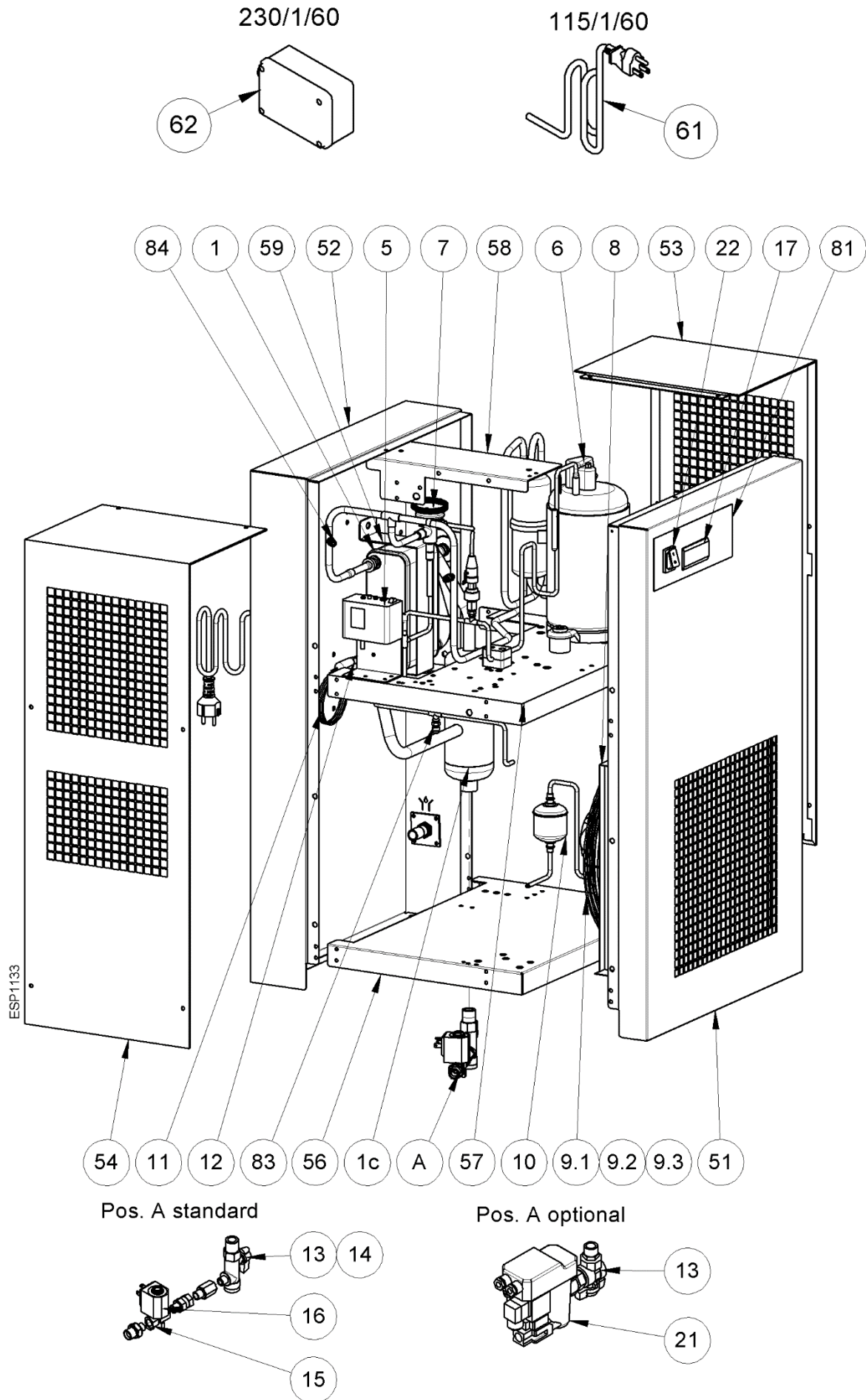

13.2.5 Exploded diagram DRYPOINT RS 180-350 HP50 NA Air-Cooled

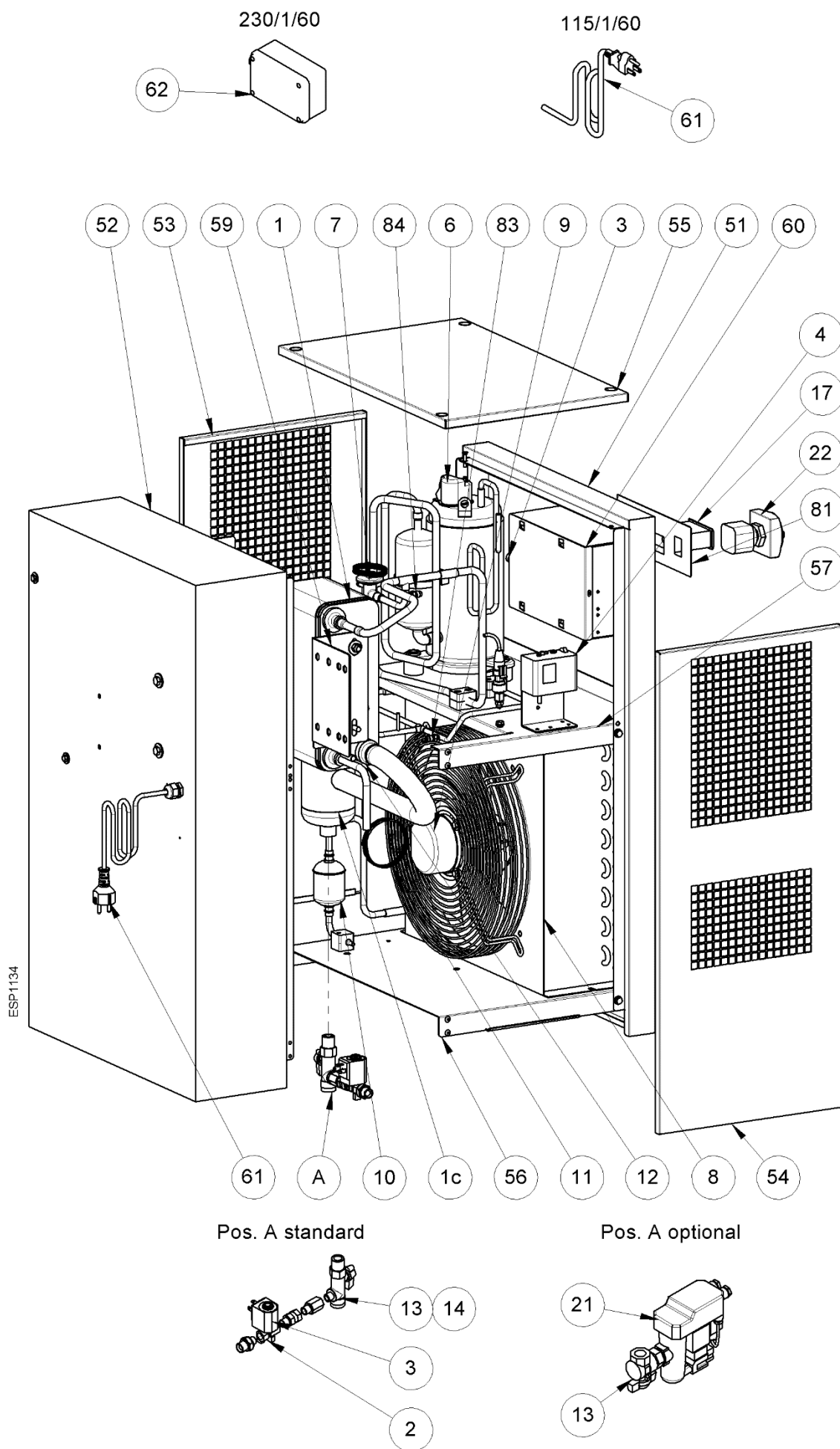

13.2.6 Exploded diagram DRYPOINT RS 180-350 HP50 NA Water-Cooled

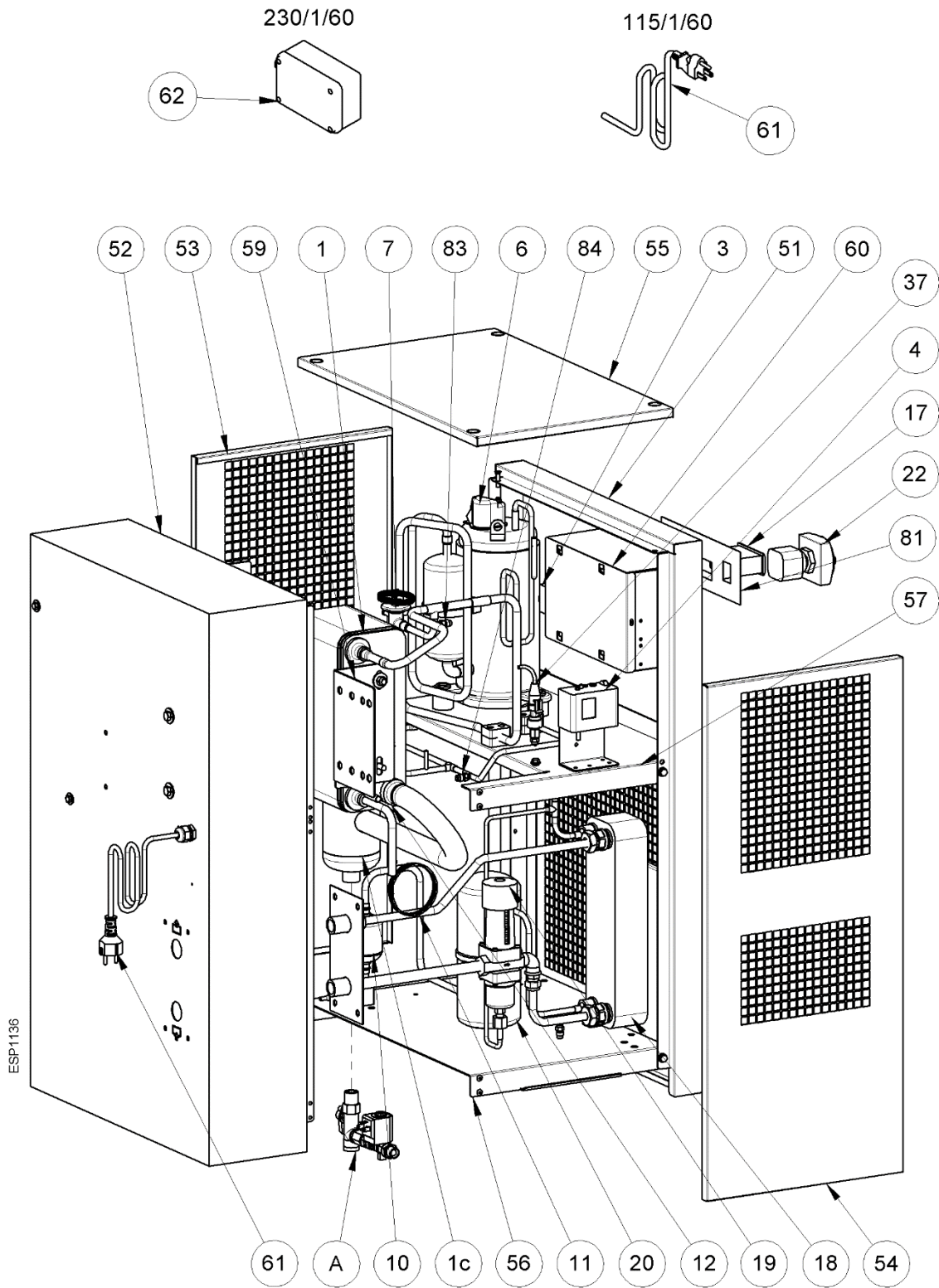

Pos. A standard

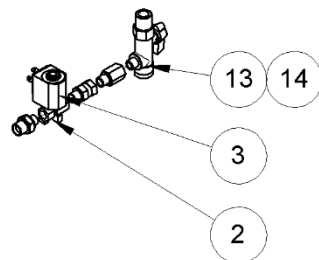

Pos. A optional

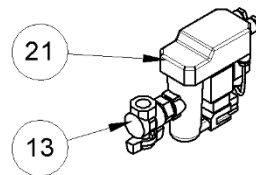

13.2.7 Exploded diagram DRYPOINT RS 450-550 HP50 NA Air-Cooled

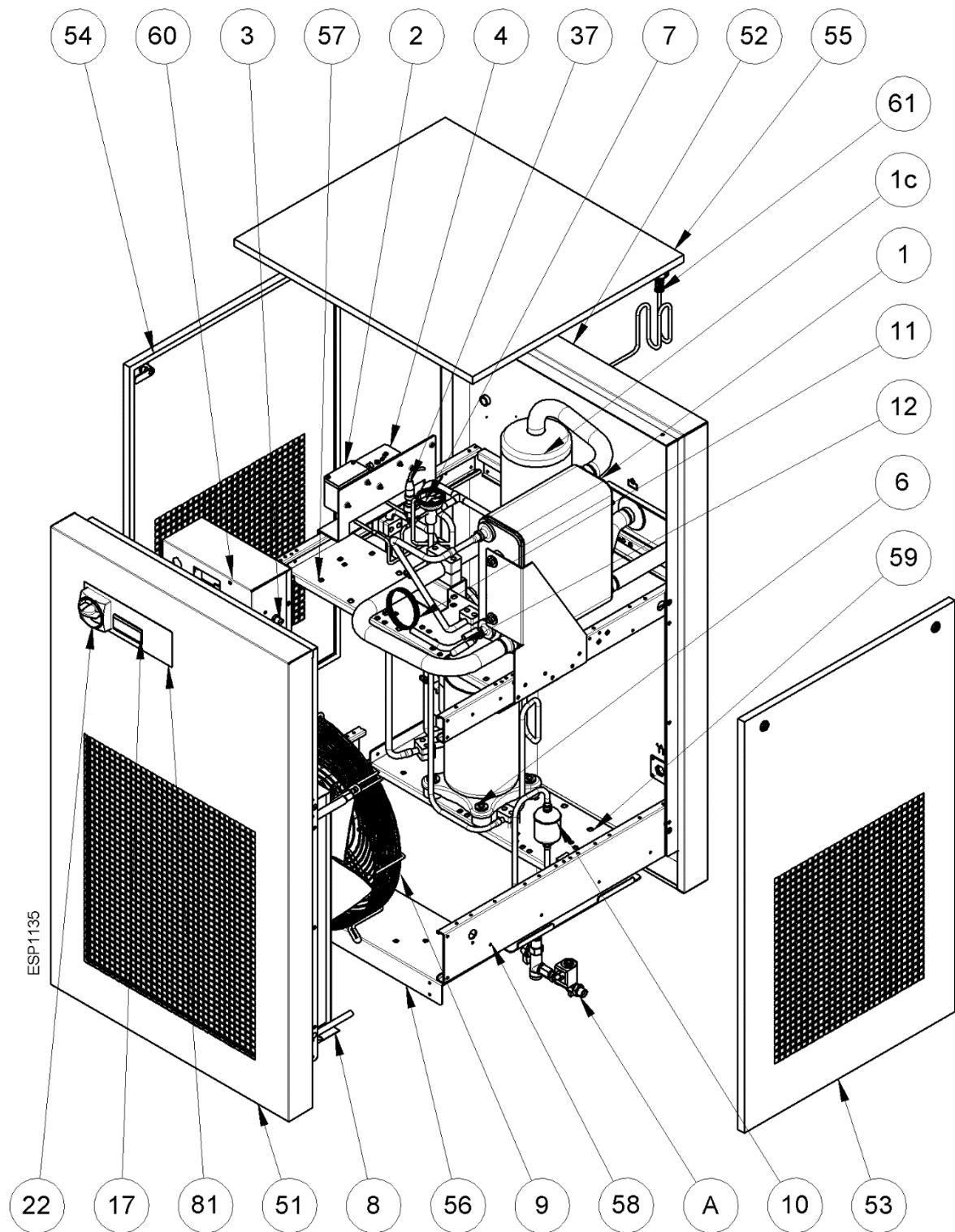

Pos. A standard

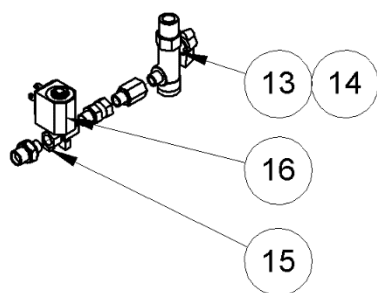

Pos. A optional

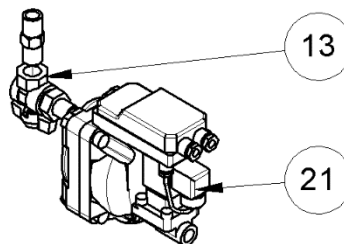

13.2.8 Exploded diagram DRYPOINT RS 450-550 HP50 NA Water-Cooled

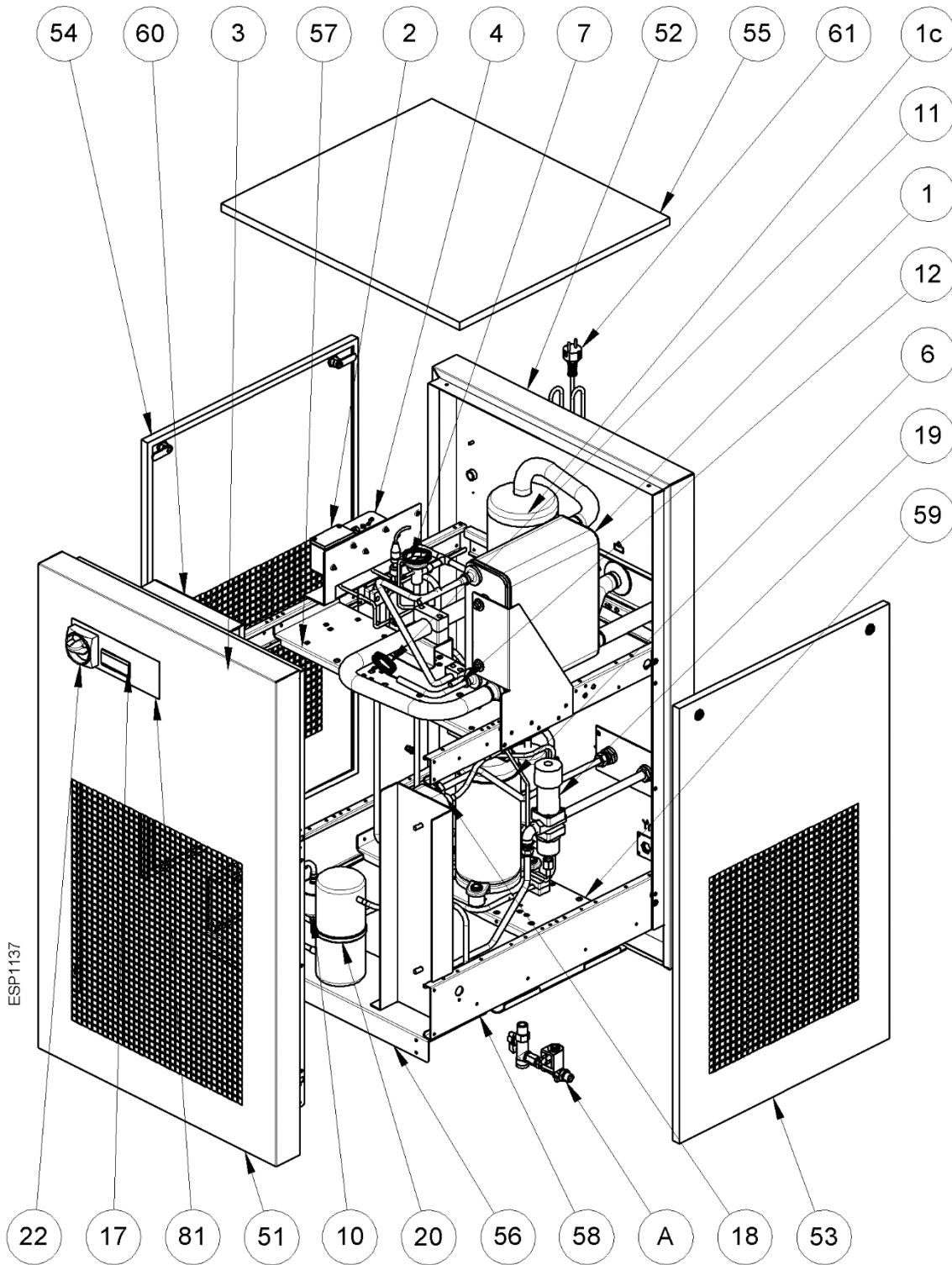

Pos. A standard

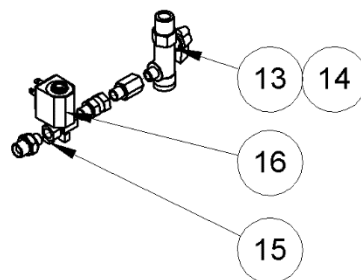

Pos. A optional

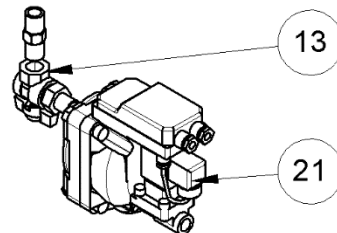

13.2.9 Exploded diagram DRYPOINT RS 180-350 HP50 NA 3phase Air-Cooled

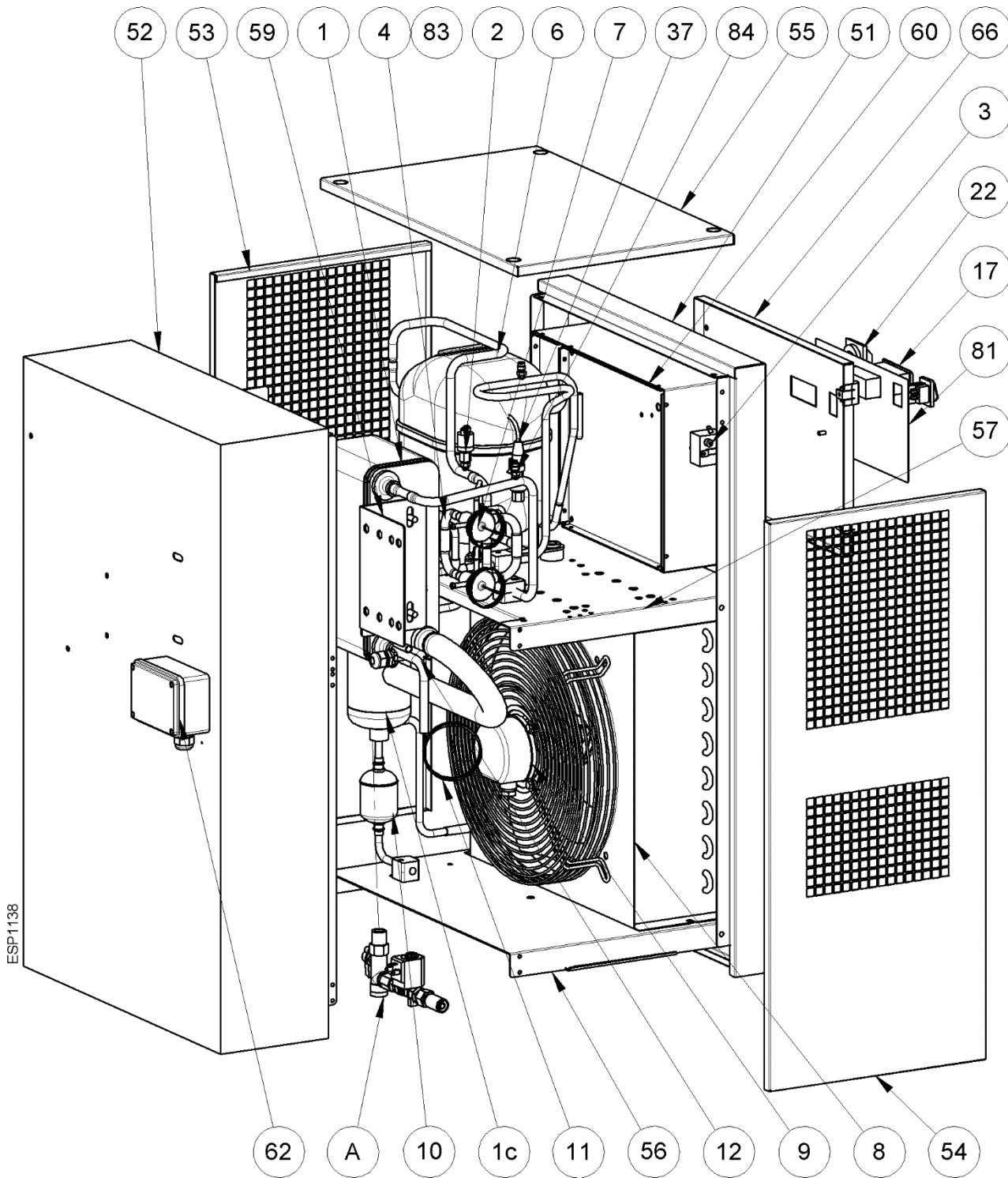

Pos. A standard

Pos. A optional

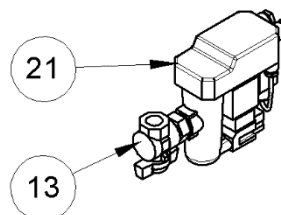
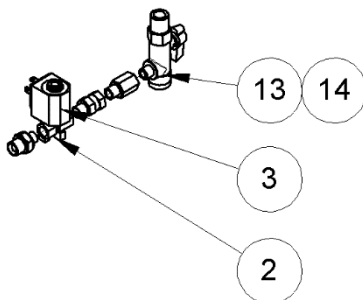

13.2.10 Exploded diagram DRYPOINT RS 180-350 HP50 NA 3phase Water-Cooled

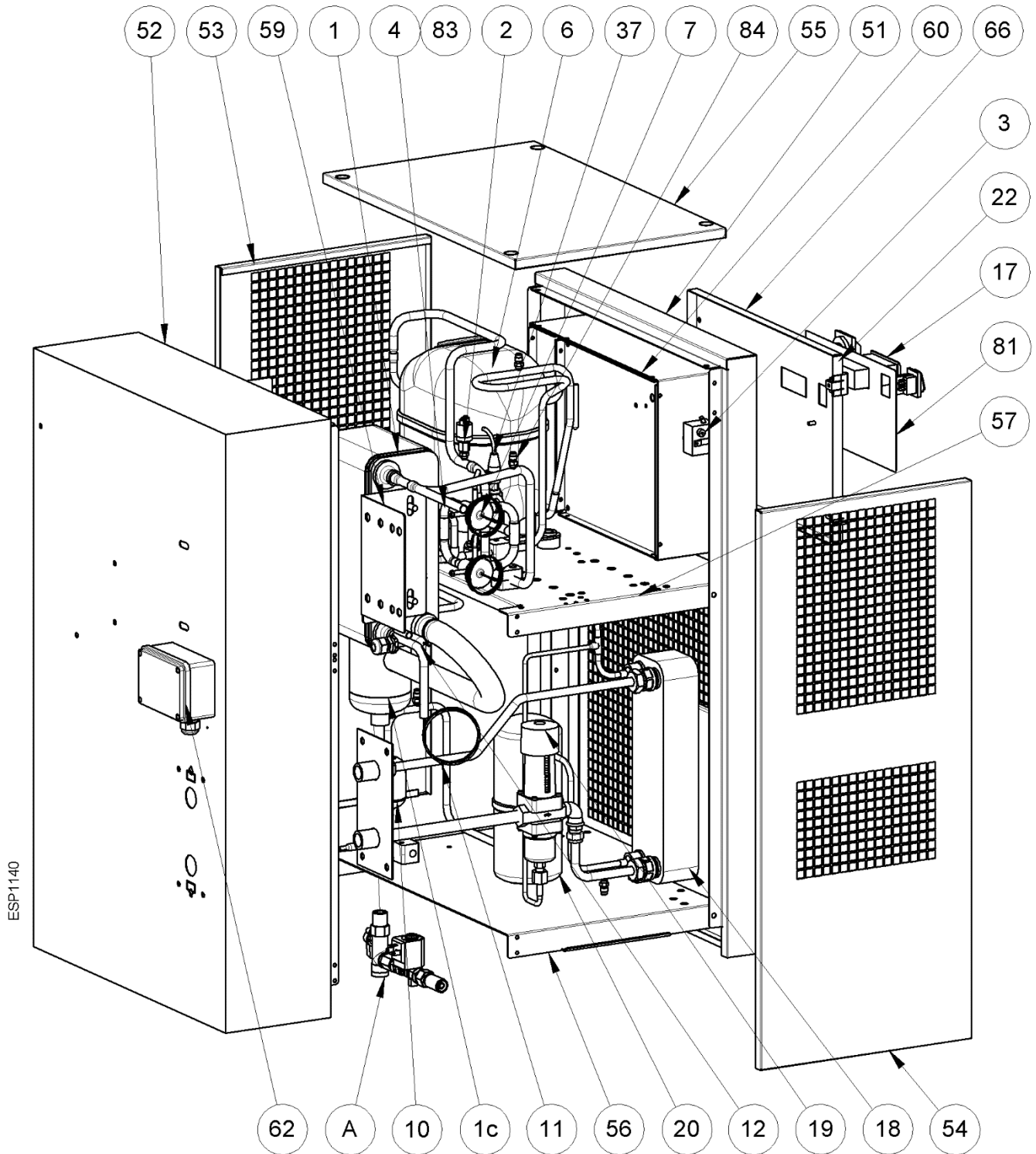

Pos. A standard

Pos. A optional

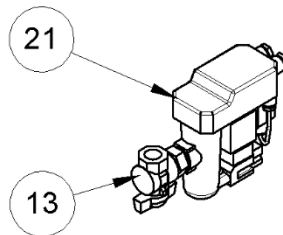
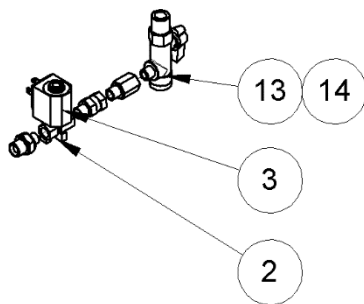

13.2.11 Exploded diagram DRYPOINT RS 450-550 HP50 NA 3phase Air-Cooled

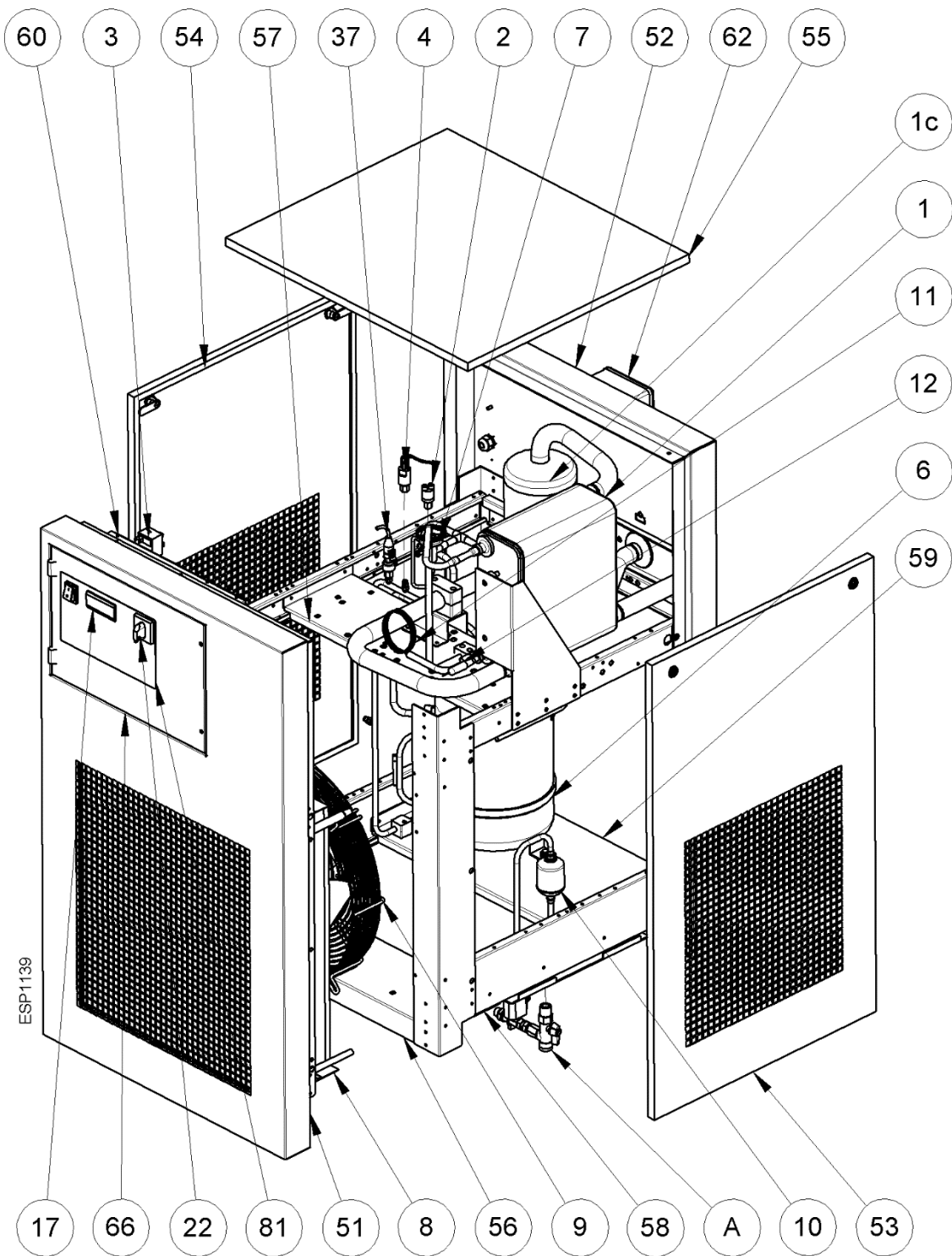

Pos. A standard

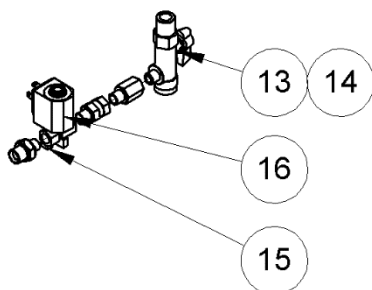

Pos. A optional

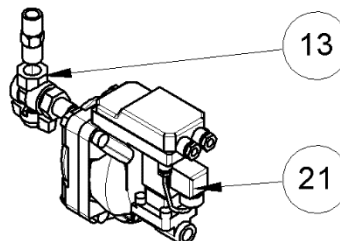

13.2.12 Exploded diagram DRYPOINT RS 450-550 HP50 NA 3phase Water-Cooled

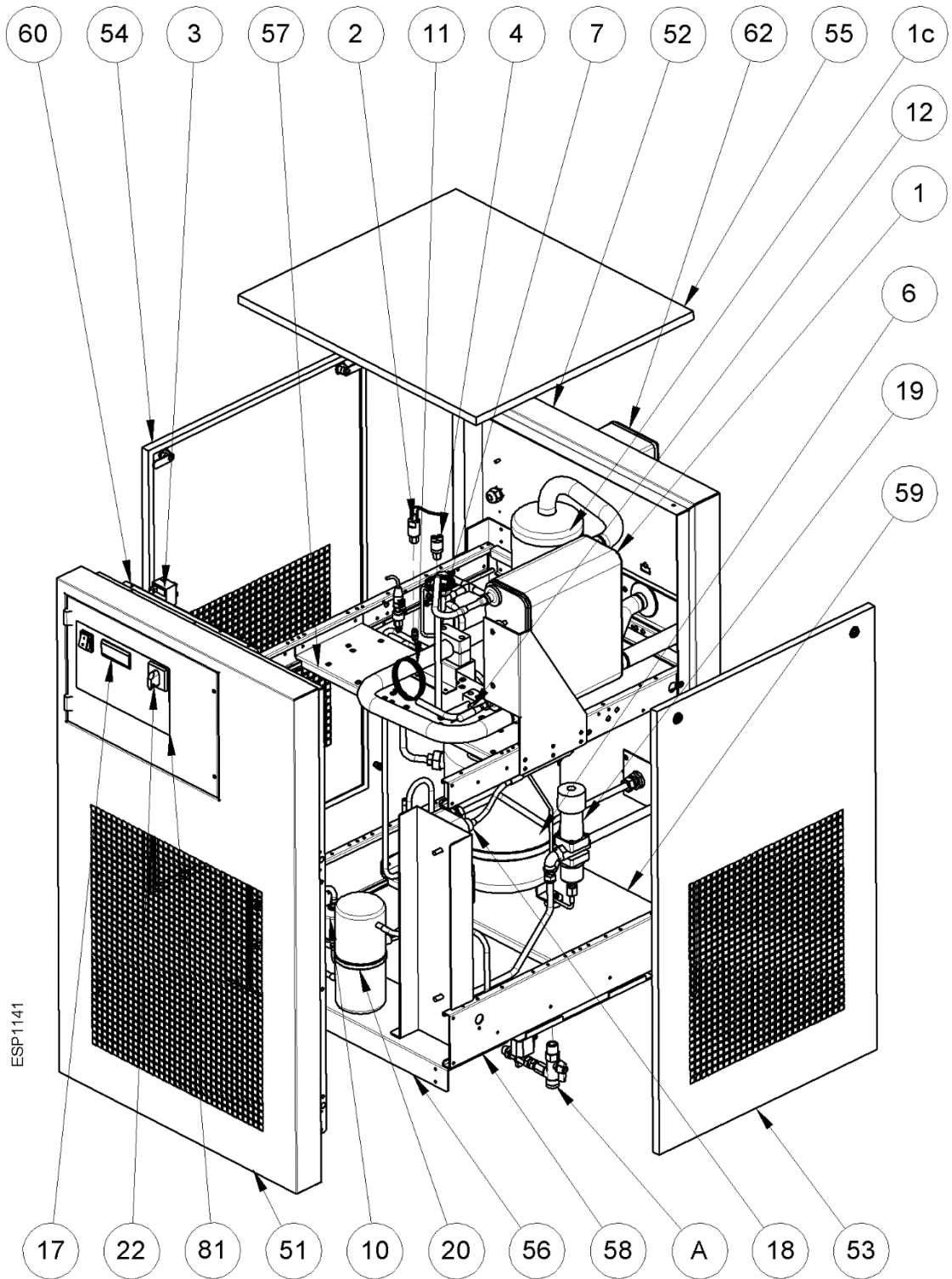

Pos. A standard

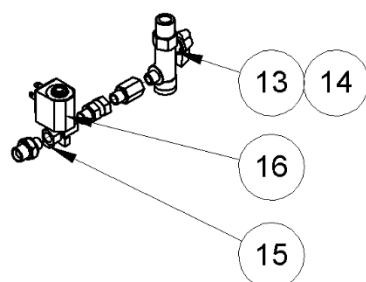

Pos. A optional

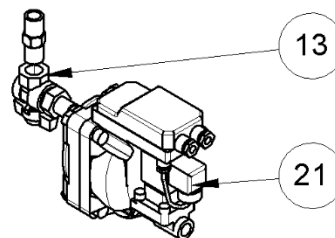

13.3 Electric diagrams

13.3.1 Electric diagrams – list of components

- MC** : Compressor
 - KT** : Compressor thermal protection
 - KR** : Compressor starting relay (if installed)
 - CS** : Compressor starting capacitor (if installed)
 - CR** : Compressor operating capacitor (if installed)
- MV** : Condenser fan
 - CV** : Fan starting capacitor (if installed)
- DMC15** : DMC15 electronic instrument – air dryer control
 - BT1** : T1 Temperature probe – dew point
 - BT1** : T2 Temperature probe – fan control
- DMC14** : DMC14 Electronic Instrument - Air Dryer Controller
 - BT1** : T1 Temperature probe – dew point
- HPS** : Pressure switch – compressor discharge side (HIGH PRESSURE)
- LPS** : Pressure switch – compressor suction side (LOW PRESSURE)
- PV** : Pressure switch – fan control
- TS** : Safety temperature switch
- ELD** : BEKOMAT drain
- S1** : ON/OFF switch
- QS** : Main switch with locking device
- RC** : Compressor crankcase heater
- TR** : Autotransformer
- BOX** : Electrical connection

- NT1** : Only air-cooled
- NT2** : Check the transformer connections with regard to the supply voltage
- NT3** : Jump, if not installed
- NT4** : Provided and cabled by the customer
- NT5** : Internal control
- NT6** : Time-controlled drain outlet (not used)
- NT7** : Only water-cooled

- BN** = BROWN **OR** = ORANGE
- BU** = BLUE **RD** = RED
- BK** = BLACK **WH** = WHITE
- YG** = YELLOW/GREEN **WH/BK** = WHITE/BLACK

13.3.2 Electric diagram DRYPOINT RS 15-40 HP50 NA

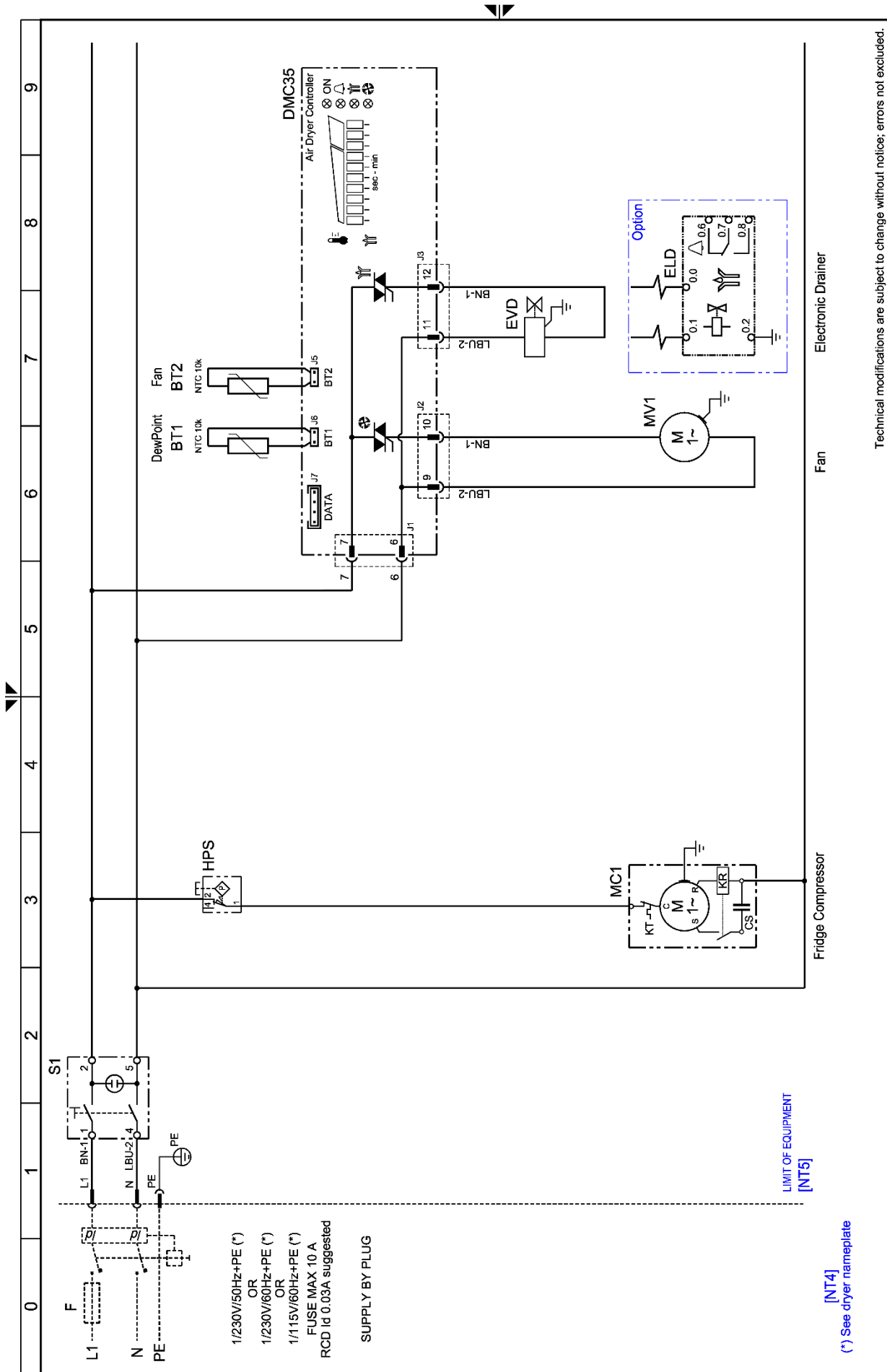

Technical modifications are subject to change without notice; errors not excluded.

Rev.

Drawing no. :

WD001_V11

Note :

00

Sheet 01 of 01

13.3.4 Electric diagram DRYPOINT RS 100-140 HP50 NA

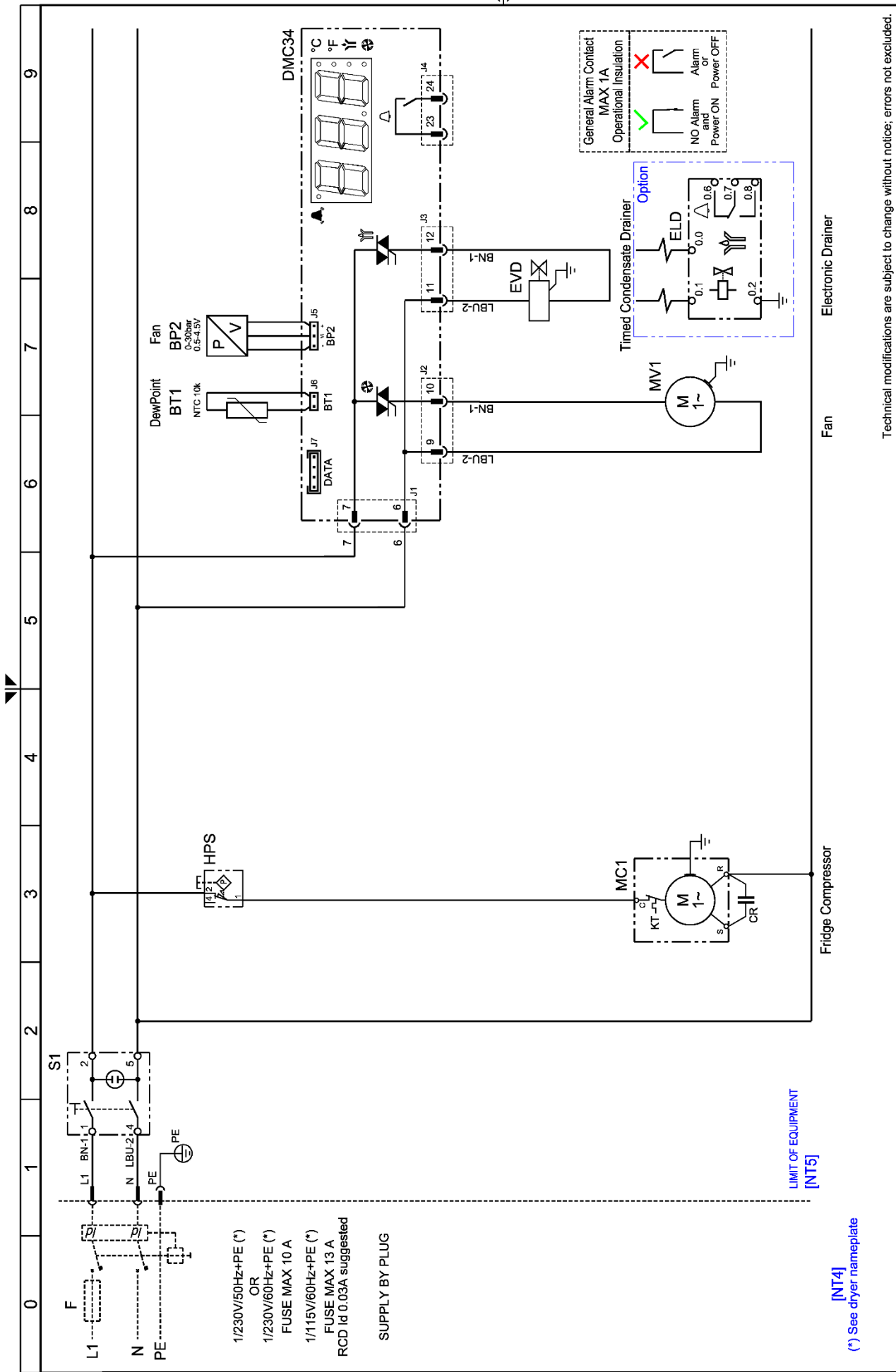

13.3.5 Electric diagram DRYPOINT RS 180-260 HP50 NA

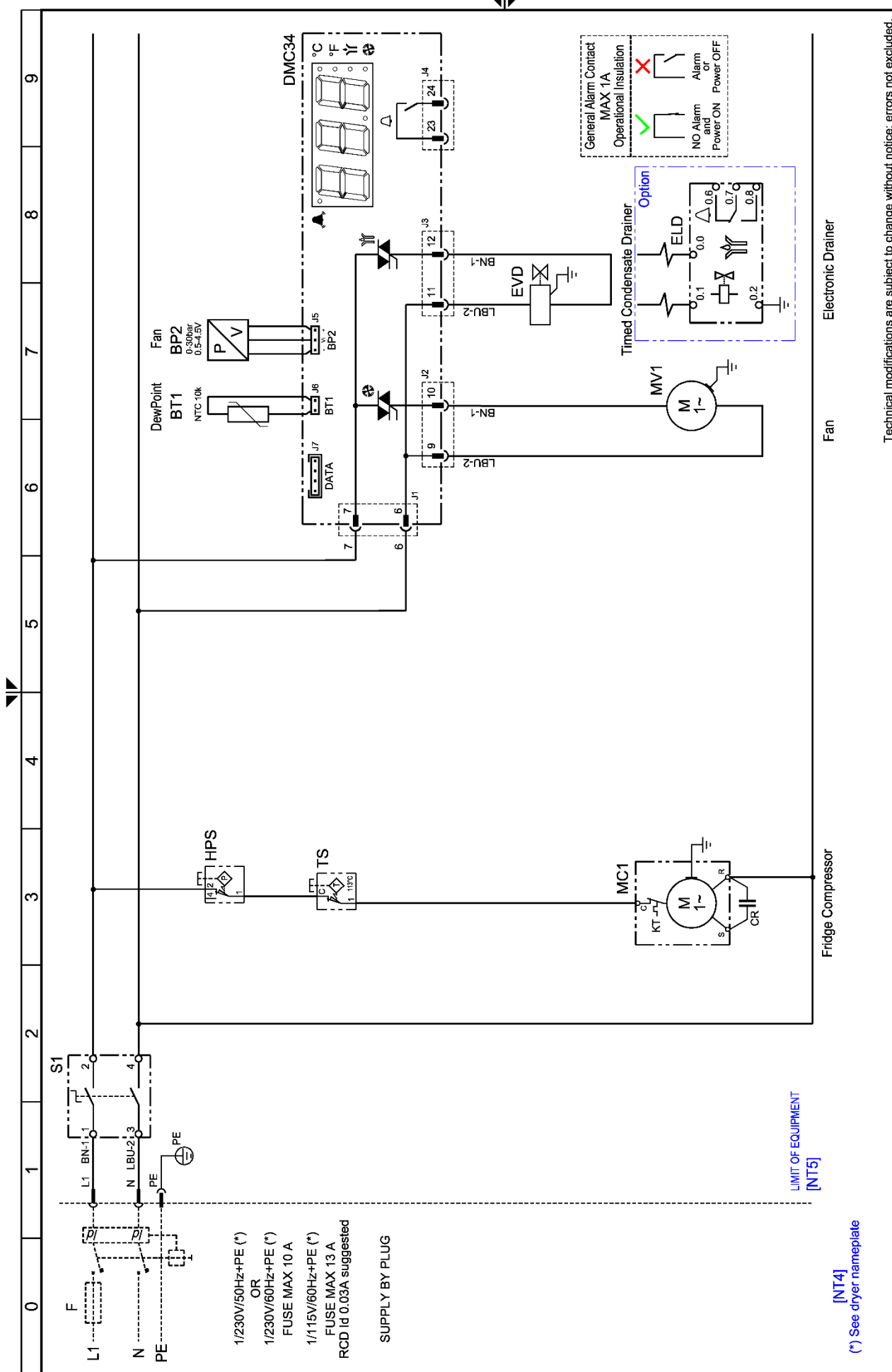

Technical modifications are subject to change without notices, errors not excluded.

Drawing no. : WD018_V00

Rev. 00

Note :

Sheet 01 of 01

13.3.6 Electric diagram DRYPOINT RS 350 HP50 NA

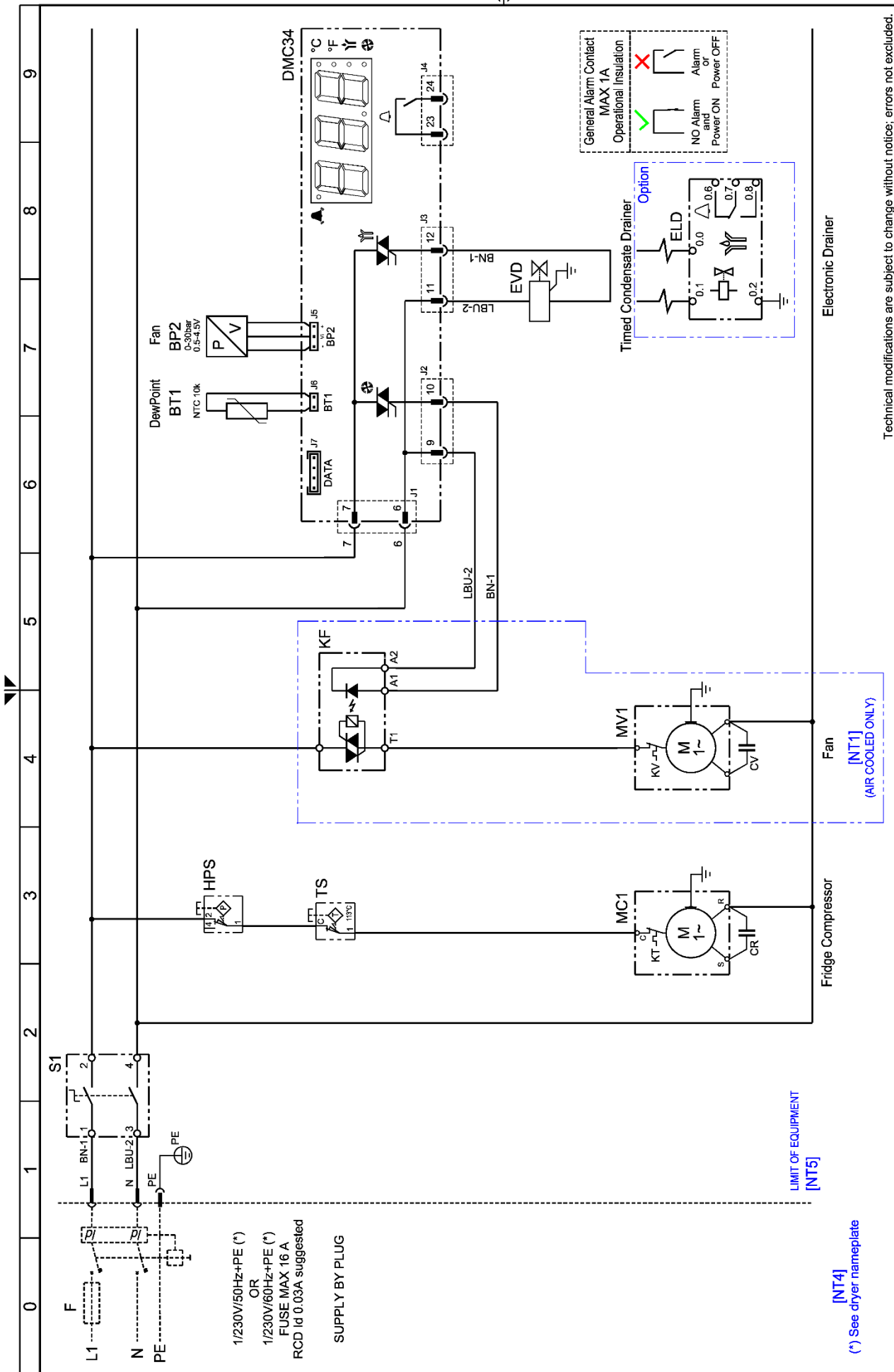

Technical modifications are subject to change without notice; errors not excluded.

Rev.

WD019_V00

00

Note :

Sheet 01 of 01

13.3.7 Electric diagram DRYPOINT RS 450-550 HP50 NA

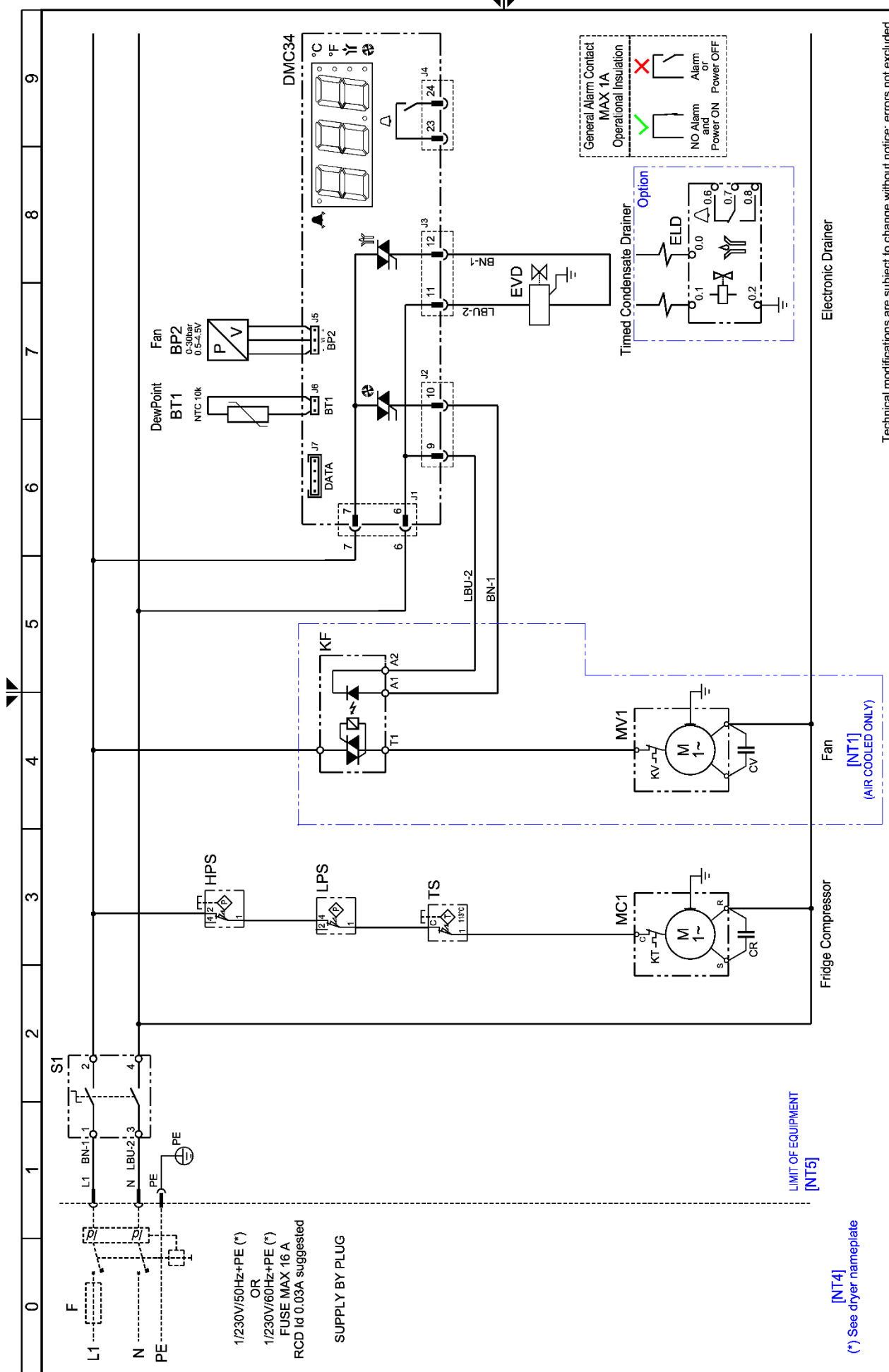

Technical modifications are subject to change without notice; errors not excluded.

Rev.

WD020_V00

00

Sheet 01 of 01

13.3.8 Electric diagram DRYPOINT RS 180-350 HP50 NA 3phase Sheet 1/3

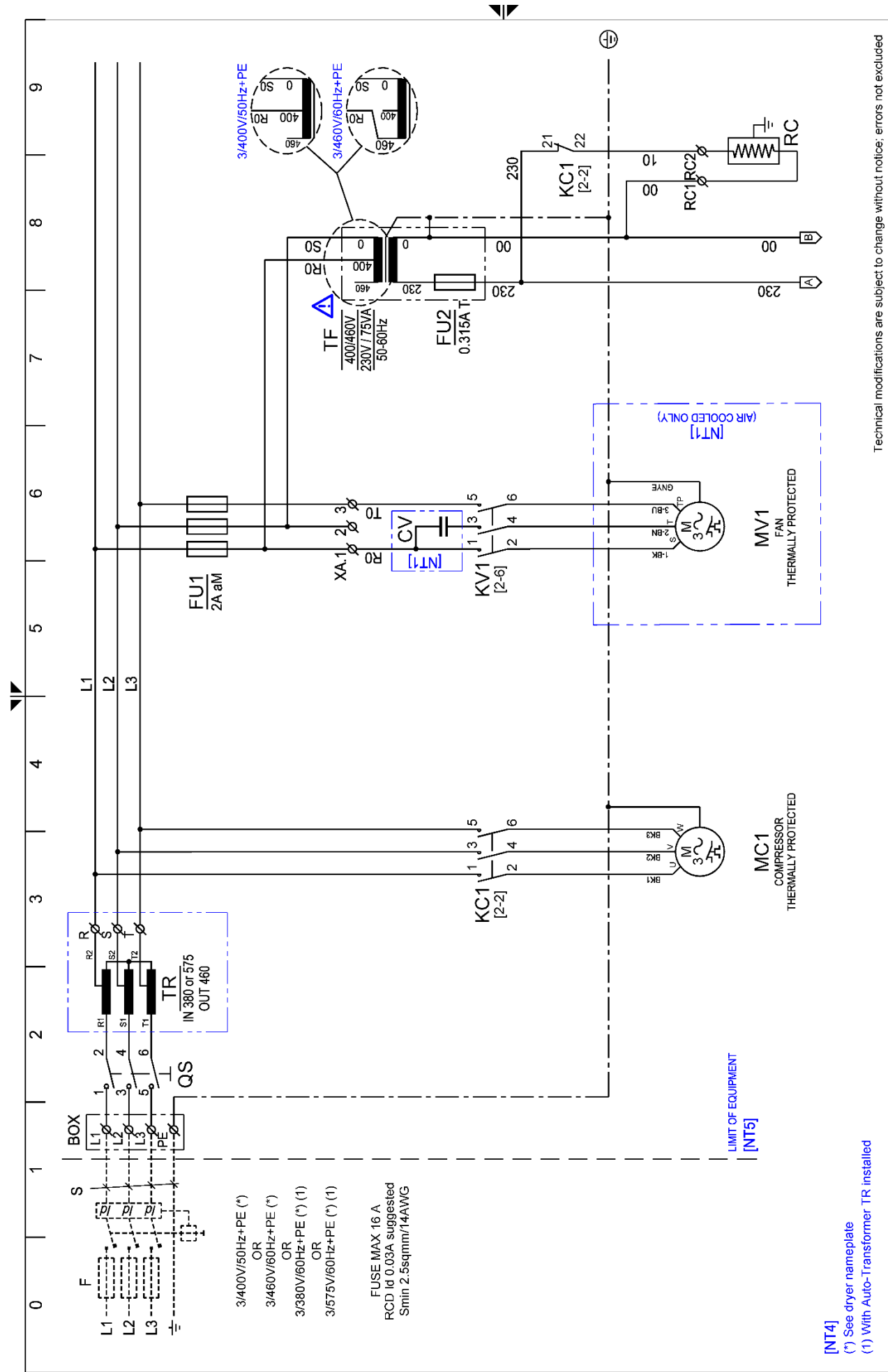

Technical modifications are subject to change without notice, errors not excluded

Rev. 01
Drawing no. : WD5478QCD061_V05
Note :

13.3.9 Electric diagram DRYPOINT RS 180-350 HP50 NA 3phase Sheet 2/3

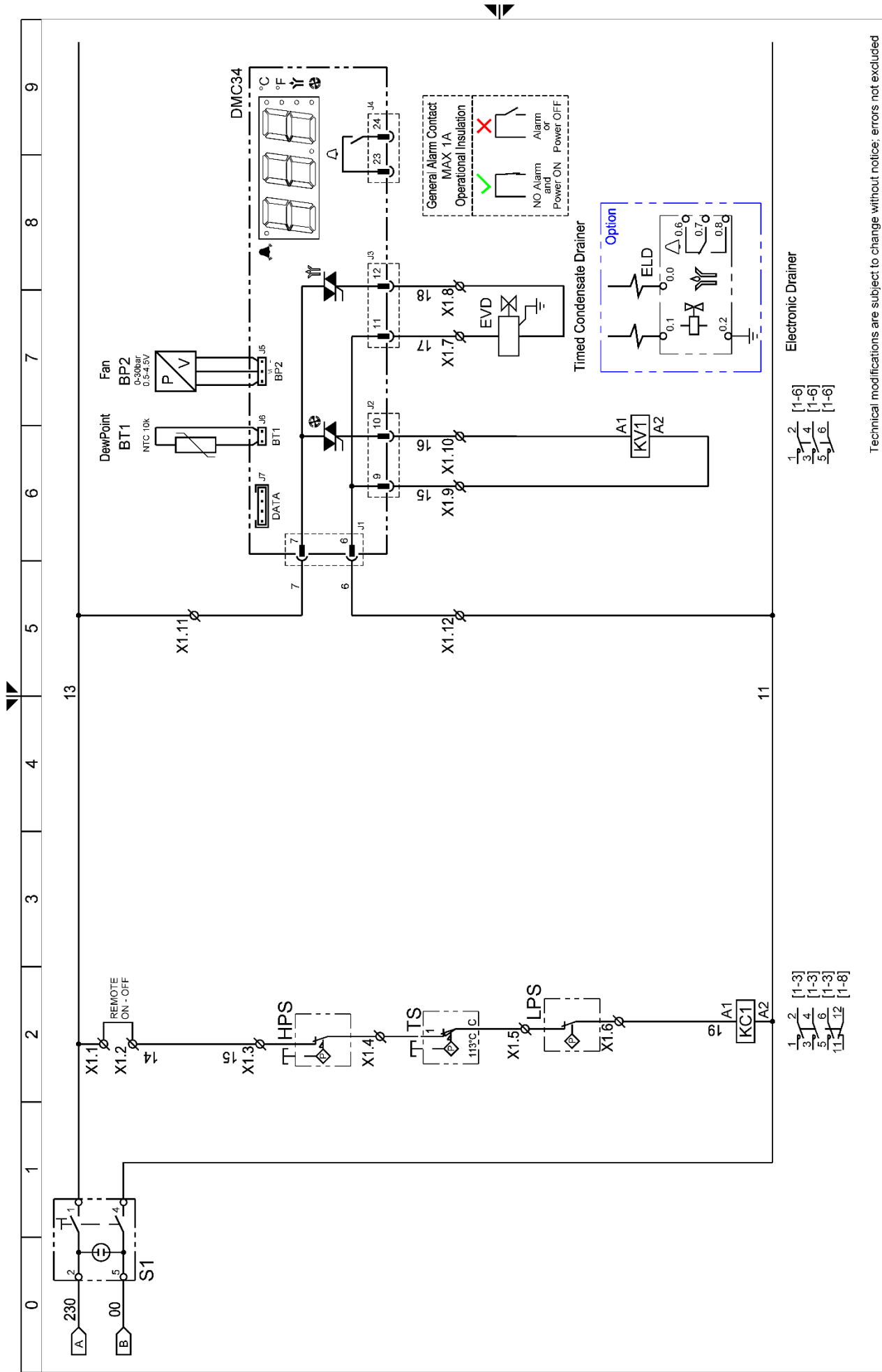

- Electronic Drainer
- 1 2 [1-6]
 - 3 4 [1-6]
 - 5 6 [1-6]

- 1 2 [1-3]
- 3 4 [1-3]
- 5 6 [1-3]
- 11 12 [1-8]

Technical modifications are subject to change without notice; errors not excluded

Drawing no. : WD5478QCD061_V05
 Rev. 01
 Note : -
 Sheet 02 of 03

13.3.11 Electric diagram DRYPOINT RS 450-550 HP50 NA 3phase Sheet 1/3

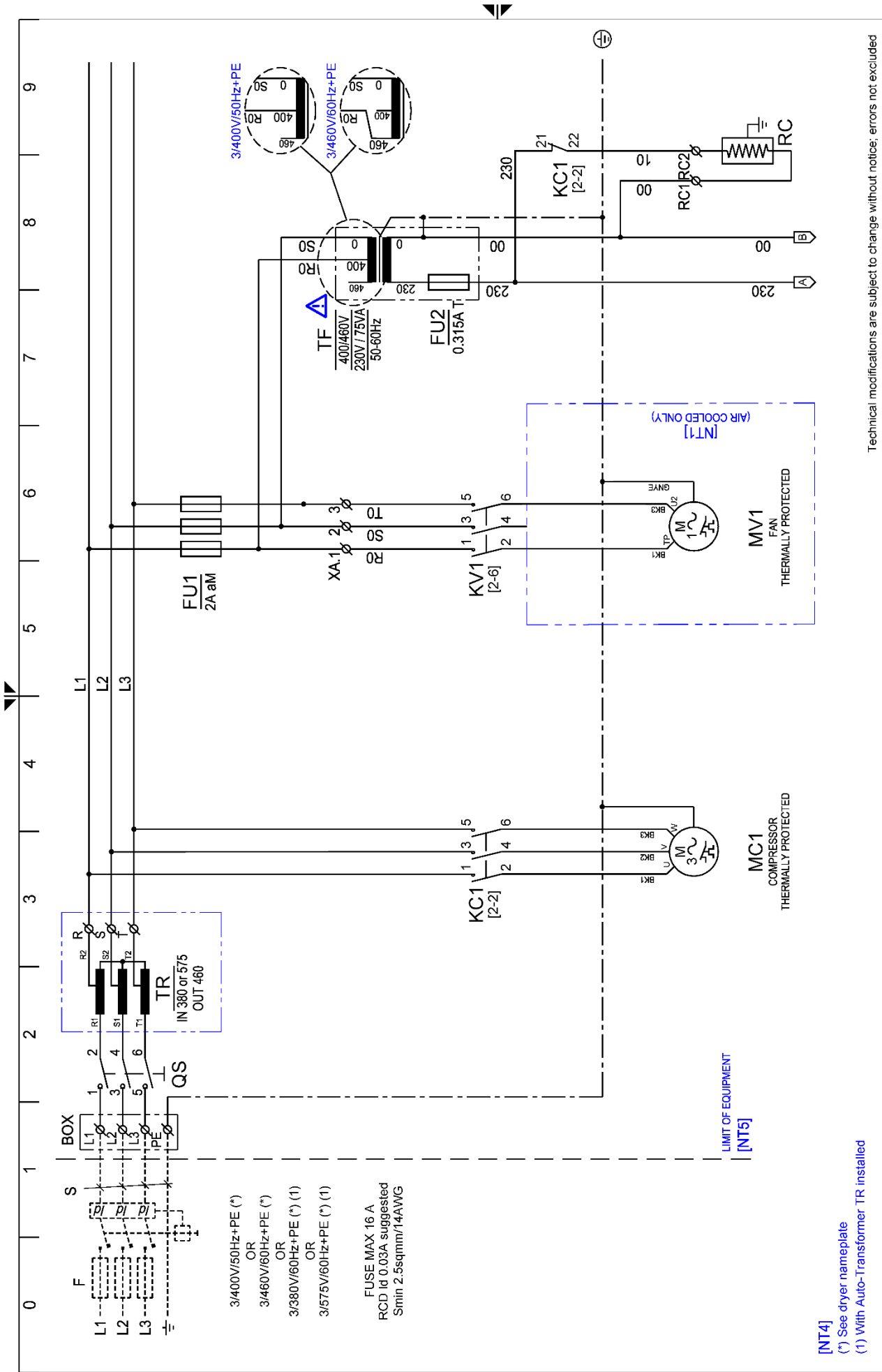

[NT4]

(*) See dryer nameplate

(1) With Auto-Transformer TR installed

Rev. 01
WD5478QCD061_V06
Note: -
Sheet 01 of 03

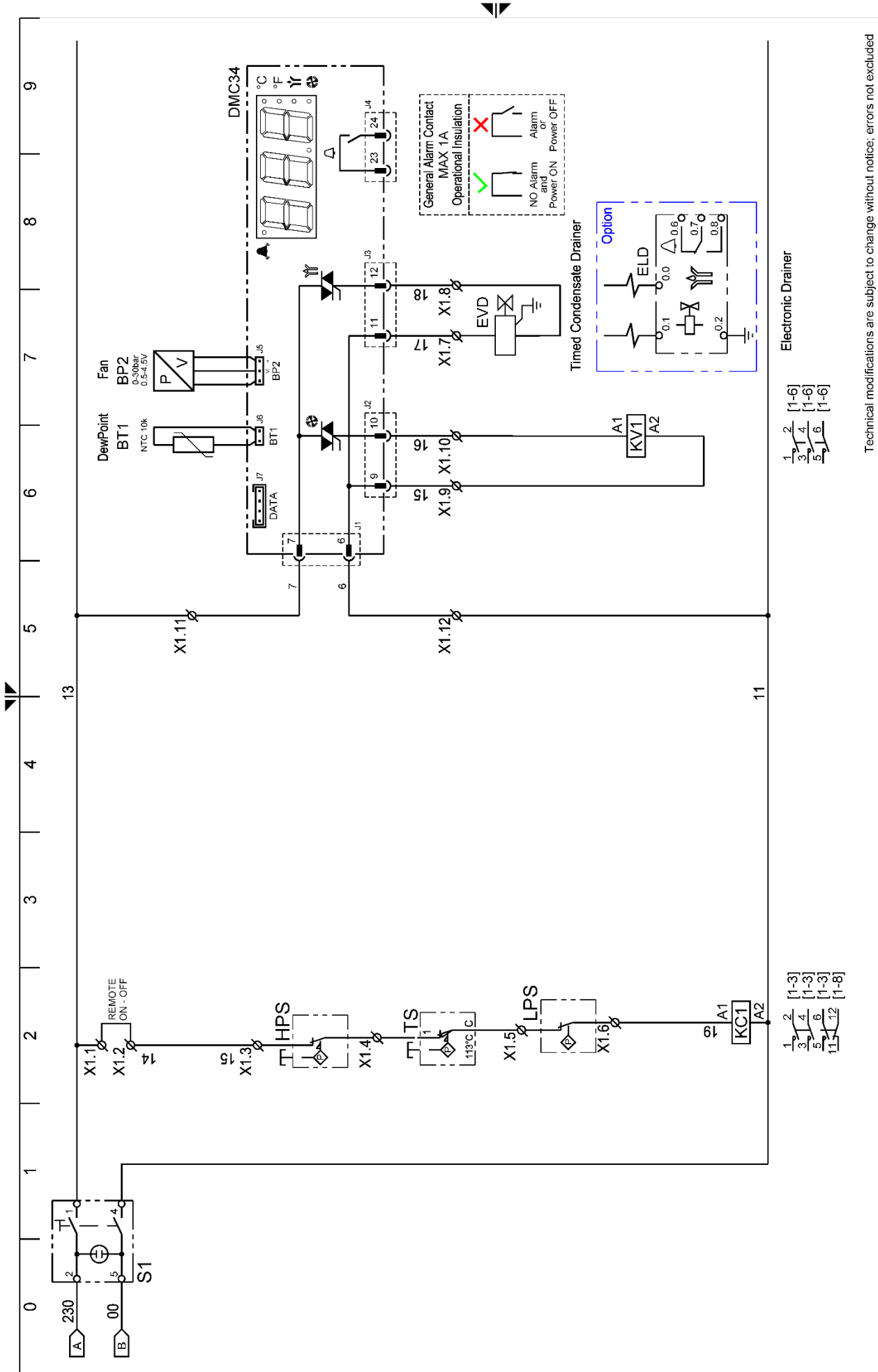

Technical modifications are subject to change without notice; errors not excluded

Drawing no.: **WD5478QCD061_V06**
 Rev. **01**
 Note: **Sheet 02 of 03**

<p>Headquarter :</p> <p>Deutschland / Germany BEKO TECHNOLOGIES GMBH Im Taubental 7 D-41468 Neuss Tel. +49 2131 988 0 info@beko-technologies.de</p>	<p>中华人民共和国 / China BEKO TECHNOLOGIES (Shanghai) Co. Ltd. Rm. 606 Tomson Commercial Building 710 Dongfang Rd. Pudong Shanghai China P.C. 200122 Tel. +86 21 508 158 85 info@beko-technologies.cn</p>	<p>France BEKO TECHNOLOGIES S.a.r.l. Zone Industrielle 1 rue des Frères Rémy F- 57200 Sarreguemines Tel. +33 387 283 800 Info@beko-technologies.fr</p>
<p>India BEKO COMPRESSED AIR TECHNOLOGIES Pvt. Ltd. Plot No.43/1, CIEEP, Gandhi Nagar, Balanagar, Hyderabad 500 037, INDIA Tel. +91 40 23080275 eric.purushotham@bekoindia.com</p>	<p>Italia / Italy BEKO TECHNOLOGIES S.r.l Via Peano 86/88 I - 10040 Leini (TO) Tel. +39 011 4500 576 info.it@beko-technologies.com</p>	<p>日本 / Japan BEKO TECHNOLOGIES K.K KEIHIN THINK 8 Floor 1-1 Minamiwatarida-machi Kawasaki-ku, Kawasaki-shi JP-210-0855 Tel. +81 44 328 76 01 info@beko-technologies.jp</p>
<p>Benelux BEKO TECHNOLOGIES B.V. Veenen 12 NL - 4703 RB Roosendaal Tel. +31 165 320 300 benelux@beko-technologies.com</p>	<p>Polska / Poland BEKO TECHNOLOGIES Sp. z o.o. ul. Chłapowskiego 47 PL-02-787 Warszawa Tel. +48 22 855 30 95 info.pl@beko-technologies.pl</p>	<p>Scandinavia www.beko-technologies.de</p>
<p>España / Spain BEKO Tecnológica España S.L. Torruella i Urpina 37-42, nave 6 E-08758 Cervelló Tel. +34 93 632 76 68 info.es@beko-technologies.es</p>	<p>South East Asia BEKO TECHNOLOGIES S.E.Asia (Thailand) Ltd. 75/323 Romklao Road Sansab, Minburi Bangkok 10510 - Thailand Tel. +66 2-918-2477 info.th@beko-technologies.com</p>	<p>臺灣 / Taiwan BEKO TECHNOLOGIES Co.,Ltd 16F.-5, No.79, Sec. 1, Xintai 5th Rd., Xizhi Dist., New Taipei City 221, Taiwan (R.O.C.) Tel. +886 2 8698 3998 info@beko.com.tw</p>
<p>Česká Republika / Czech Republic BEKO TECHNOLOGIES s.r.o. Mlýnská 1392 CZ - 562 01 Usti nad Orlici Tel. +420 465 52 12 51 info.cz@beko-technologies.cz</p>	<p>United Kingdom BEKO TECHNOLOGIES LTD. 2 West Court Buntsford Park Road Bromsgrove GB-Worcestershire B60 3DX Tel. +44 1527 575 778 info@beko-technologies.co.uk</p>	<p>USA BEKO TECHNOLOGIES CORP. 900 Great SW Parkway US - Atlanta, GA 30336 Tel. +1 404 924-6900 beko@bekousa.com</p>

Original operating instructions in English.

Subject to technical changes / errors excepted.

DRYPOINT_RS_15-550_NA_manual_en_2020_04

74MD0019A2-EN_01