

EN

Installation and Operating Manual

Heatless Regenerated Dryer

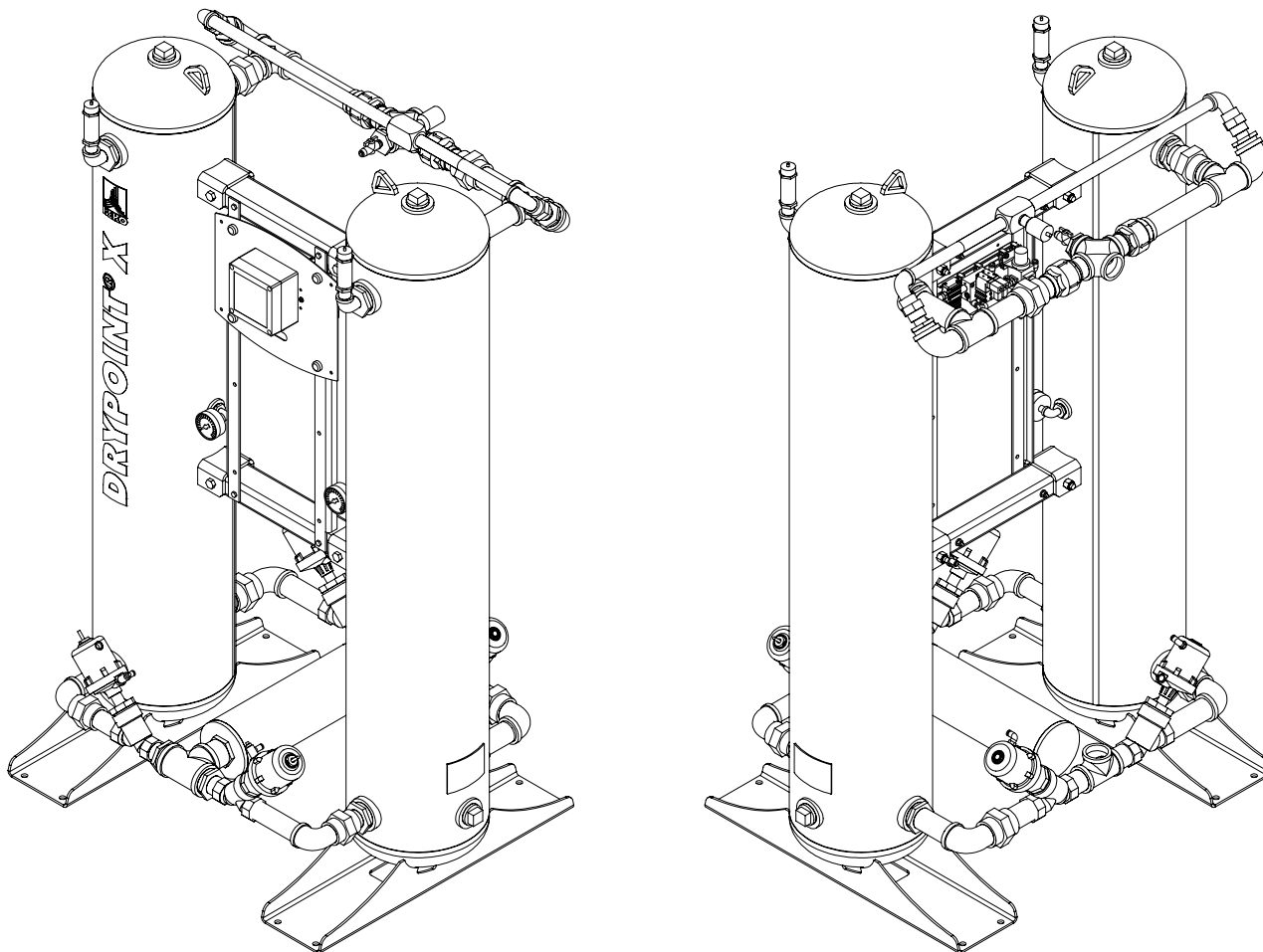

DRYPOINT® XC Economy Series

XCe models 80 to 800 with BEKOMINI Controller

READ MANUAL FIRST BEFORE INSTALLATION AND OPERATION



Contents















1. SAFETY AND SYSTEM PRECAUTIONS	3
1.1 Definition of the Safety Symbols	3
1.2 Operational Warnings	3
2. INSPECTION AND INSTALLATION	4
2.1 Incoming Inspection and Transportation	4
2.2 Design and Use of the Dryer	4
2.3 Location and Installation	4
2.4 Mounted Filters with Bypass	6
3. TECHNICAL SPECIFICATIONS AND GENERAL FUNCTION	7
3.1 Technical Data by Model Size	7
3.2 Correction Factors	8
3.3 General Function	8
3.4 Flow Diagram	9
3.5 Cycle Operation	10
4. PURGE VALVE ADJUSTMENT	11
5. START-UP	12
5.1 Verification Prior to Start-up	12
5.2 Start-up Procedures	13
5.3 General Operation	14
6. ISOLATION AND SHUT DOWN PROCEDURES	14
7. CONTROLLER INFORMATION AND OPERATION	15
7.1 Display Overview	15
7.2 Startup	15
7.3 Controller Inputs	15
7.4 Controller Outputs	16
7.5 Controller Settings	16
7.6 Service Rest Button	18
7.8 Power Requirements	18

- 8. MAINTENANCE AND SERVICE19**
 - 8.1 Routine Maintenance 19
 - 8.2 Maintenance and Service Intervals 20
 - 8.3 Fuses 20
 - 8.4 Desiccant Replacement 21
 - 8.5 Inlet and Exhaust Valve Repair 21
- 9. TROUBLESHOOTING GUIDE22**
- 10. MAINTENANCE AND SPARE PARTS25**
 - 10.1 Required Maintenance Parts 25
 - 10.2 Spare Parts 27
- 11. DISMANTLING OF THE DRYER28**
- 12. ELECTRICAL WIRING DIAGRAM29**
- 13. GENERAL DESCRIPTION OF PARTS29**

For technical product support please call +1 (800) 235-6797 and select Option 2

1. SAFETY AND SYSTEM PRECAUTIONS

1.1 Definition of the Safety Symbols

					
Before attempting any service, please read the manual	General Warning: Risk of damage or injury	Electrical Hazard: Possibility of electro-cution	Warning: Under pressure	Warning: High temperature	Warning: Non-breathable air
					
Warning: Water cannot be used to extinguish fire	Warning: Do not operate if parts are missing or have been tampered with	Warning: Machine level noise may exceed 85 dBA	Warning: Personal protection required	Warning: All work to be performed by qualified personnel only	Operations that can be performed by qualified operators ¹
					
Compressed air inlet connection		Compressed air outlet connection		Connection point for condensate drain	

¹ Only experienced and trained personnel familiar with all of the relevant laws, rules and regulations, capable to perform the needed activities and to identify and avoid possible dangerous situations while handling, installing, using and servicing the machine.

1.1 Operational Warnings

WARNING: VESSELS UNDER PRESSURE

- + In most countries, states, cities and/or local municipalities the installation, operation and maintenance of devices where pressure vessels are in use are subject to local boiler and pressure vessel regulations.
- + The end user is responsible for following all of the relevant laws, rules and regulations and ensuring that only experienced and trained personnel install and/or operate the dryer.
- + In most countries, states, cities and/or local municipalities the installation may only be carried out by a licensed installation company. Inspections must be carried out by a qualified and licensed third-party firm in accordance with all applicable laws, rules and regulations for the region where the dryer is installed.
- + The pressure vessels used in this device are built according to the American Society of Mechanical Engineers (ASME) standard Section 8, Division 1.



Compressed Air Warning:

Compressed air is a highly dangerous energy source.

- + Never work on the dryer while components are under pressure.
- + Never point the compressed air stream or the condensate drain outlet towards anybody.

The end user is responsible for the installation of the dryer as laid out in this manual. If proper commissioning steps are not followed, the warranty will be void and dangerous situations involving injury or death and/or damages to the machine could occur.



- Only qualified personnel can use and service electrically powered devices. Before attempting any maintenance:
- + Ensure that no part of the machine is powered and is locked out of the electrical mains by following proper "Lock-out, Tag-out" procedures and requirements.
 - + Ensure that no part of the dryer is under pressure by isolating the dryer from the compressed air system.



Any change to the machine or to the standard operating parameters (see page 5), if not previously verified and authorized by the manufacturer, in addition to creating a potentially dangerous situation, will void the warranty.



Don't use water to extinguish fire on the dryer or in the surrounding area.

2. INSPECTION AND INSTALLATION

2.1 Incoming Inspection and Transportation

All dryers are tested and inspected at the factory prior to shipping. Thoroughly inspect and verify the integrity of the packaging upon receipt and note any damage on the freight bill. Place the unit as close as possible to the installation point before unpacking the contents and inspect for concealed damage. Freight claims are to be filed with the carrier immediately and the manufacturer's technical service department notified thereafter.

- + To move the packaged unit, we suggest the use of a suitable crane or forklift. We do not recommend moving the unit by any hand operated or manual mechanism.
- + Handle with care. Heavy blows could cause irreparable damage.
- + Even when packaged, keep the machine protected from severe weather.



The packaging materials are recyclable. Each material must be properly disposed in a manner complying with the rules and regulations of the local municipality government.

2.2 Design and Use of the Dryer

This dryer has been designed, manufactured and tested to be used only to separate the humidity normally contained in compressed air; any other use is considered to be improper. The manufacturer is not responsible for any problems arising from the improper use of this machine.

The end user, in any and all cases, is responsible for any resulting damages.

Moreover, the correct use of this machine requires the verification of certain installation conditions, in particular:

- + Voltage and frequency of the electrical power supplied
- + Pressure, temperature, flow rate and chemical composition of the incoming compressed air
- + Ambient temperatures

The dryer is supplied as tested and fully assembled. The only operation left for the end user is the connection to the plant air and adjustment of the purge rate in compliance with the instructions given in this manual. Factory settings are at nominal conditions at 100 psig and the stated model flow rate (see sect. 3).



The purpose of the machine is the separation of water vapor that is present in compressed air. It is not intended to separate oil or other contaminants that are present in compressed air. The dried compressed air output from this dryer cannot be used for respiration purposes of any kind.

2.3 Location and Installation



Serious consideration should be given when selecting the installation site for the dryer, as an improper location could directly affect the proper operation of the dryer.

This unit is not suitable to be used in explosive atmospheres, where risk of fire could exist, in the presence of gaseous or solid pollutants or in outdoor applications or areas exposed to the elements.



Do not use water to extinguish fire on the dryer or in the surrounding area.



Machine level noise could be higher than 85 dBA. Install the unit in a dedicated area where people are not normally present. The installer and/or end user is responsible for the correct installation of the dryer in order to prevent excessive noise exposure in the work environment. The installer and/or end user is responsible to install proper safety signs at the installation site.



Technicians that service the machine must wear hearing and eye protection while servicing the dryer. Each employee must select a proper personal protection device (PPD) hearing protector such as earmuffs, ear canal caps or earplugs in order to prevent permanent hearing damage or loss.

Minimum Installation Requirements:

- + Select a clean, dry room that is free of dust and protected from atmospheric disturbances.
- + The equipment foundation must be smooth, horizontally level, able to bear the weight of the dryer and vibration free
- + Minimum ambient temperature of +40 °F
- + Maximum ambient temperature of +120 °F
- + Allow a clearance of at least 3' on all sides of the dryer in order to easily facilitate all maintenance needs
- + The dryer is required to be anchored to the supporting surface
- + Coalescing pre-filter with drain must be installed
- + The location of an air receiver tank will vary depending on compressor type and application conditions



Incorrect installation may void warranty.

NOTE: All piping and electrical connections should be inspected prior to installation to ensure they have maintained their integrity during shipping and locating the dryer.

First, make the initial connections as follows:



1. Inlet piping including an isolation valve
2. Outlet piping including an isolation valve
3. Coalescing pre-filter and particulate post-filter



We recommend the dryer be installed with a 0.01 micron CLEARPOINT® coalescing pre-filter at the inlet and a 1.0 micron CLEARPOINT® particulate post-filter at the outlet. It is recommended to install both 5.0 micron and 1.0 micron filters upstream of the dryer in order to maintain the operational lifespan of the inlet filter to the dryer. In addition, we recommend the use of a BEKOMAT® zero air loss drain on the pre-filter and at all other condensate collection points, especially those upstream of the dryer.

Locate the coalescing pre-filter as close to the dryer as possible while still maintaining sufficient space for routine maintenance and service. Inlet air entering the dryer must pass through a coalescing pre-filter in order to remove entrained condensate and oil to prevent fouling of the desiccant and maintain standard operation. Any liquid condensate entering the desiccant bed will lead to overloading of the dryer, poor dew point performance and rapid deterioration of the desiccant material. Any oil entering the desiccant bed may permanently reduce the capacity of the desiccant material.

Desiccant dust traveling downstream of the dryer may cause contamination and/or accelerated wear to other components and equipment. Therefore, a particulate post-filter should be provided to prevent desiccant dust from traveling downstream. Activated alumina is considered a nuisance dust and proper precautions should be taken when handling desiccant (refer to applicable MSDS sheet).



4. **IMPORTANT!** Bypass piping is necessary. Only bubble tight valves should be used.
5. Make the required electrical connections; please refer the type plate of your dryer. The end user is responsible for providing short circuit protection for the dryer.
6. Points of access should be provided upstream and downstream of the dryer for periodic monitoring of dew point, pressure and temperature prior to finalizing the installation. Taking periodic dew point measurements just downstream of the dryer gives the best indication of whether the dryer is performing optimally. We recommend using METPOINT® instrumentation to ensure accurate measurements.
7. All piping must be adequately supported and at least of equal size to the dryer connections.

Optimal Installation Diagram

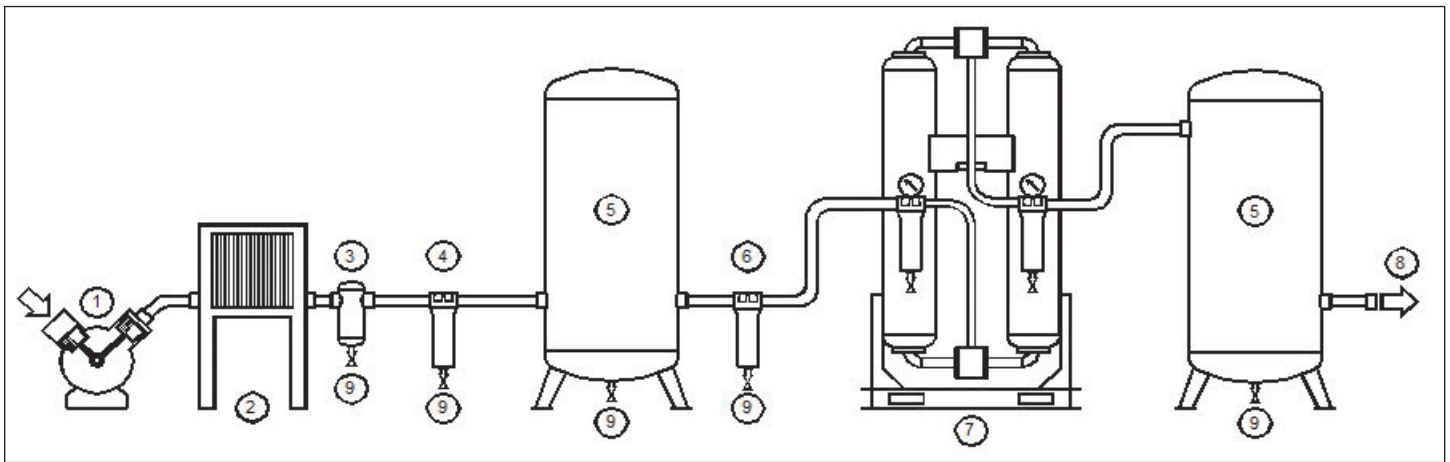

1	Air Compressor
2	After Cooler
3	CLEARPOINT® In-line Water Separator
4	CLEARPOINT® 5.0 Micron (Grade G) Filtration
5	Receiver Tank
6	CLEARPOINT® 1.0 Micron (Grade F) Filtration
7	DRYPOINT® XCe Desiccant Dryer with CLEARPOINT® Pre and Post-filtration
8	Dry Air Outlet
9	Condensate Drainage Points for BEKOMAT®

Optimal installation is with moderately-sized receivers at the inlet and outlet side of the dryer. This allows for the additional free cooling and moisture collection and more consistent dryer inlet flow provided by an upstream receiver, while providing the most reliable shop air supply due to the downstream receiver.

Under no circumstances should the peak demand air flow exceed the maximum rated air flow of the dryer.



We recommend the dryer be installed with a 0.01 micron CLEARPOINT® coalescing pre-filter at the inlet and a 1 micron CLEARPOINT® particulate post-filter at the outlet. It is recommended to install both 5 micron and 1 micron filters upstream of the dryer in order to maintain the operational lifespan of the inlet filter.

2.4 Mounted Filters with Bypass

Mounted Filters with Bypass is an optional setup for DRYPOINT XC. The three valve system bypass allows for the flow of air to be uninterrupted while servicing or completing preventative maintenance such as:

- + Exchange pre- and post- filters
- + Services exhaust silencers
- + Change desiccant

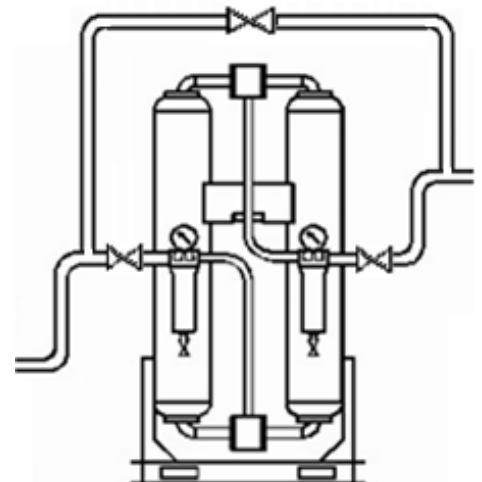

3. TECHNICAL SPECIFICATIONS AND GENERAL FUNCTION

3.1 Technical Data by Model Size

DRYPOINT® XCe	Model Size	80	100	120	160	200	250	300	400	500	650	800
Flow Rate	scfm	80	100	120	160	200	250	300	400	500	650	800
Inlet / Outlet Connection	in. (NPT-F)	¾	1	1	1 ¼	1 ¼	1 ½	1 ½	2	2	2 ½	2 ½
Height (A)	in.	54	64	64	68	68	69	69	71	73	74	71
Width (B)	in.	37	38	38	40	40	45	45	49	53	57	61
Depth (C)	in.	22	23	23	26	26	30	30	35	36	40	43
Adsorbent Material	Activated Alumina	⅝"										
Total per Dryer	Lbs.	132	167	167	262	262	384	384	539	715	917	1114
Outlet Pressure Dew Point	°F	-40										
Minimum Ambient Temperature	°F	40										
Maximum Ambient Temperature	°F	120										
Standard Inlet Air Temperature	°F	100										
Maximum Inlet Air Temperature	°F	120										
Minimum Air Pressure	psig	60										
Standard Air Pressure	psig	100										
Maximum Air Pressure	psig	150										

Optimal installation is with moderately sized receivers at the inlet and outlet side of the dryer. This allows for the additional free cooling and moisture collection and more consistent dryer inlet flow provided by an upstream receiver, while providing the most reliable shop air supply due to the downstream receiver.

Under no circumstances should the peak demand air flow exceed the maximum rated air flow of the dryer.

Dryer ratings adhere to the following inlet conditions per ISO 7183, Table 2, Option A2:



- + Inlet Compressed Air Temperature 100 °F (38 °C)
- + Inlet Compressed Air Pressure 100 psig (7 bar)
- + Maximum Ambient Air Temperature 100 °F (38 °C)
- + Inlet Compressed Air Relative Humidity 100% (Saturated)

SCFM is defined as the volume of free air in cubic feet per minute measured at 14.5 psia (1.013 bar) at 68 °F (20 °C) temperature with 0% relative humidity (0 WVP).

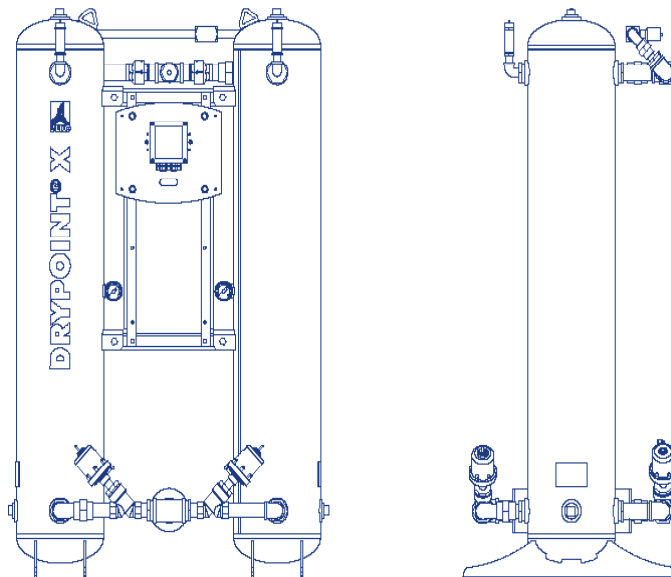

3.2 Correction Factors

Correction Factors							
	≤ 90°F	95°F	100°F	105°F	110°F	115°F	120°F
60 PSIG	0.70	0.68	0.65	0.60	0.55	0.50	0.46
70 PSIG	0.79	0.77	0.74	0.68	0.62	0.57	0.52
80 PSIG	0.88	0.85	0.82	0.75	0.69	0.63	0.57
90 PSIG	0.97	0.95	0.91	0.84	0.76	0.70	0.64
100 PSIG	1.07	1.04	1.00	0.92	0.84	0.77	0.70
110 PSIG	1.17	1.13	1.09	1.00	0.92	0.84	0.76
120 PSIG	1.25	1.22	1.17	1.08	0.98	0.90	0.82
130 PSIG	1.31	1.27	1.22	1.12	1.02	0.94	0.84
140 PSIG	1.34	1.30	1.25	1.15	1.05	0.96	0.88
150 PSIG	1.39	1.35	1.30	1.20	1.09	1.00	0.91

How to Determine Dryer Capacity at Operating Conditions:

ADJUSTED CAPACITY =
Standard Flow Rate x Correction Factor

Example:

Dryer Model: DRYPOINT® XCe 250
Standard Flow Rate: 250 scfm
Operating Conditions: 110 psig / 110 °F
ADJUSTED CAPACITY = 250 scfm x 0.92 = **230 scfm**

How to select the dryer for actual conditions:

ADJUSTED CAPACITY =
System Flow Rate ÷ Correction Factor

Example:

System Flow Rate: 300 scfm
Operating Conditions: 130 psig / 100 °F
ADJUSTED CAPACITY = 300 scfm ÷ 1.22 = **246 scfm**
Select Dryer Model: DRYPOINT® XCe 250

3.3 General Function

The DRYPOINT® X heatless desiccant dryer series are fitted with two pressure vessels, positioned parallel to one another and filled with adsorption material (1/8" activated alumina as standard). While the compressed air is dried in one tower, the saturated desiccant is regenerated in the second. A minimal portion of the treated air is used for the regeneration process and expelled along with the condensate, through the silencers.

The saturated inlet air is cycled through each of the two desiccant beds in an alternating sequence where one bed is on-line at full line pressure and flow, adsorbing the water vapor. This is the drying bed.

The other bed is then considered to be in an off-line state at atmospheric pressure and is being regenerated by a depressurized portion of the dried, treated outlet air (purge air). This is the regenerating bed.

The purge air is routed from the dry outlet air through the purge flow control valve, desiccant bed, purge exhaust valve and finally exhausted to atmosphere through silencers to finish the regeneration process. Purge air consumption is generally the highest cost involved with operating a heatless adsorption dryer and is non-recoverable. Therefore, the air system where the dryer is installed must account for this usage (approximately 15% of the inlet air flow).

Just before the freshly regenerated bed is brought to an on-line state to become the drying bed, it is slowly pressurized from atmospheric pressure up to line pressure. This is the re-pressurization step that prevents desiccant bed fluidization (bed lifting) and dusting. The desiccant beds will now switch functions where the fresh desiccant bed is now drying and the saturated bed is now regenerating.

This cycle will continue automatically unless the dryer is shut down.

All desiccant dryers work using the principle of adsorption, which is the process by which water vapor is removed from the compressed air being dried. All desiccant material types are adversely affected by contaminants including oil,

aerosols, dirt, rust, scale and liquid water. If contaminated, the desiccant material will lose its adsorption properties. During normal operation, the desiccant will release a small amount of dust (as fine powder) that is particularly abrasive and can be extremely damaging to downstream components and users.

For this reason, it is highly recommended that the dryer is equipped with two high-efficiency CLEARPOINT® filters:

- + **0.01 micron** filtration grade coalescing **pre-filter** with differential pressure gauge and either a float drain or BEKOMAT®
- + **1.0 micron** filtration grade particulate **post-filter** (differential gauge optional) and with a manual drain.

3.4 Flow Diagram

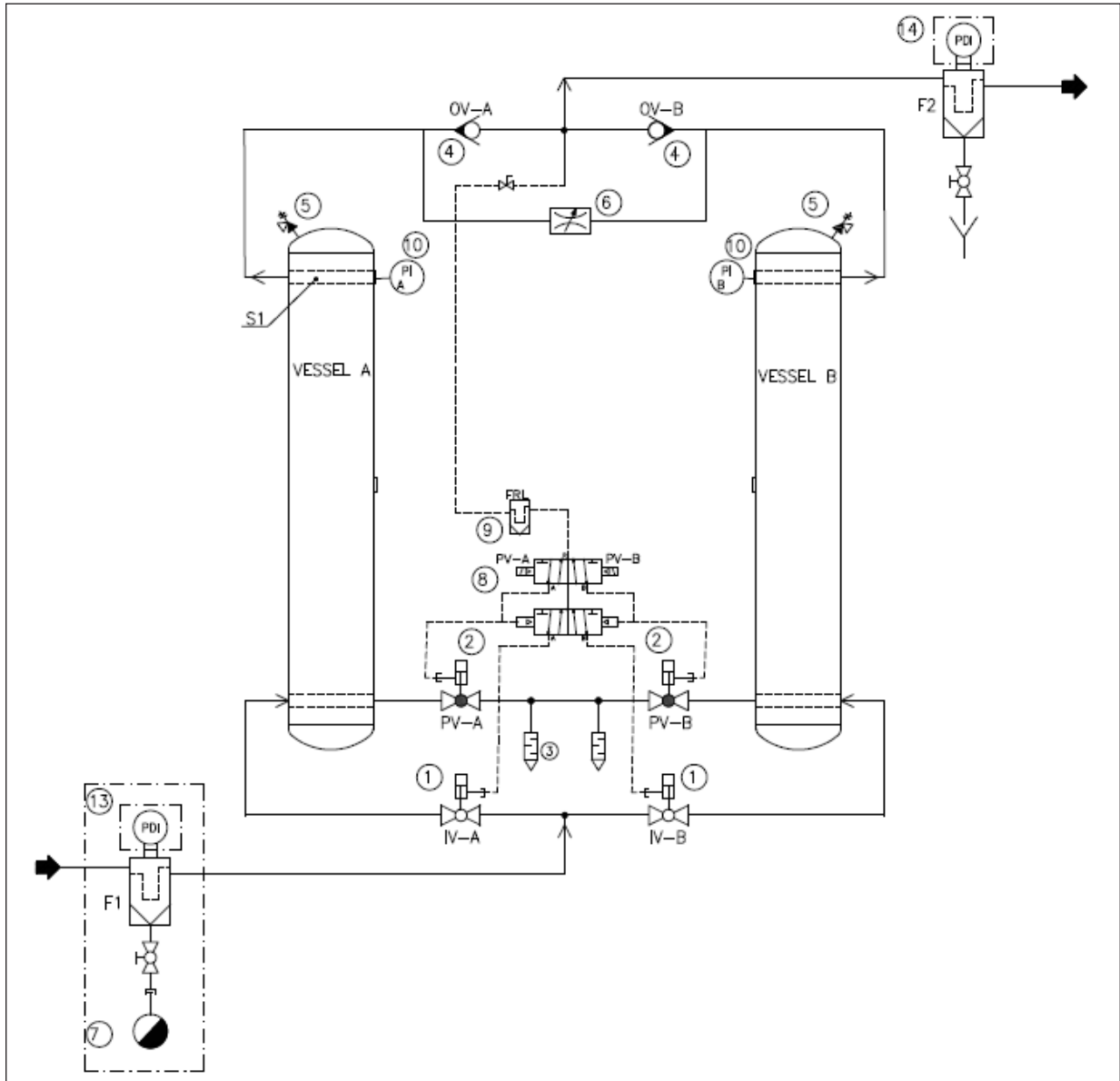

Number	Name
1	Inlet Valve (Normally Open)
2	Purge Exhaust Valve (Normally Closed)
3	Exhaust Silencer
4	Outlet Check Valves
5	Pressure Relief Valve
6	Purge Control Valve
7	Optional BEKOMAT Zero Loss Drain

Number	Name
8	Solenoid Block
9	Pilot Air Filter and Regulator
10	Vessel Pressure Gauge
11	Dew Point Sensor (Optional)
12	Energy Management System %RH
13	Pre-filter with Float Drain
14	Post-filter with Manual Drain

3.5 Cycle Operation

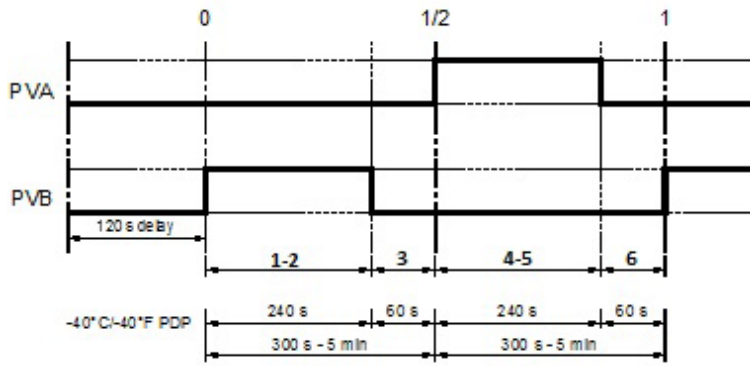

The cycle time is factory set for operation at 100 psig inlet air pressure and 100 °F inlet air temperature.

+ 10 minutes for -40 °F (-40 °C)

IV-A = Inlet Valve, Vessel A

IV-B = Inlet Valve, Vessel B

PV-A = Purge Valve, Vessel A

PV-B = Purge Valve, Vessel B

Pressurization Sequence

After proper pressurization of the dryer the operator may begin the start-up. During the start-up phase, both purge exhaust valves PVA and PVB (5 and 6) are closed for a period of 70-seconds to help guarantee the complete pressurization of the dryer.

- Step 1-2** The purge exhaust valve PV-B (2) is powered open to depressurize vessel for regeneration. Simultaneously the solenoid valve IV-B (1) is powered closed by the pneumatic tower selection. The compressed air flow is directed to vessel A, where the desiccant material adsorbs the humidity down to the target dew point. Through the purge control valve (6), a set amount of dry air discharged from tower A is expanded into vessel B. This dry air, while crossing Vessel B, dries the adsorbent material and the now moisture-laden purge air is discharged through the PV-B valve (2) and exits the silencers (3). At the end of this stage the adsorption material of vessel B is completely regenerated.
- Step 3** The purge exhaust valve PV-B (2) is closed and then through the Purge Control Valve (6) vessel B is re-pressurized to the working pressure. The sum of steps 1-2 + 3 equals a half cycle time.
- Step 4-5** The purge exhaust valve PV-A (2) is powered open to depressurize vessel for regeneration. Simultaneously the solenoid valve IV-B (1) is powered closed. The compressed air flow is directed to vessel B, where the desiccant material adsorbs the humidity down to the target dew point. Through the purge control valve (6) a defined amount of dry air coming out from tower A is expanded into vessel B. This dry air while crossing vessel A, dries the adsorbent material dragging away the humidity through the PV-A valve (2) and the silencers (3). At the end of this stage the adsorption material of vessel A is completely regenerated.
- Step 6** The purge exhaust valve PV-A (8) is closed and then through the Purge Control Valve (6) vessel A is re-pressurized up to the working pressure. The sum of step 4-5 + 6 equals a half cycle time. At the end, the cycle starts up again from step 1-2.

NOTE: The cycles are symmetrical, therefore 1-2=4-5 and 3=6

4. PURGE VALVE ADJUSTMENT

The purge flow control valve must be set to match the inlet pressure of the dryer. The valve must be opened to the corresponding number of turns referenced in the table below.

- + Always base the pressure adjustment on the lowest operating pressure of the system
- + The initial setting from factory is for 100 psig operation

The procedure for adjusting the purge flow control valve is as follows:

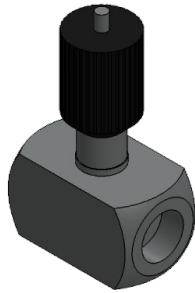

Rendered drawing of purge flow control valve



Turn knob clockwise (to the right) to close



Turn knob counter clockwise (to the left) to open

The knob stem of the valve is numbered and a complete turn is considered turning the control knob 360° from number to number. The number of turns expressed in the table below is based on the number of turns from the closed position.

1. Loosen the screw using a flathead screwdriver or allen-head
2. Turn the purge flow control valve clockwise until the stopping point – the valve is now closed
3. Turn the purge flow control valve counter clockwise until the setting for the desired operating pressure value is reached – the valve is now open
4. Tighten the screw using a flathead screwdriver or allen-head

Purge Adjustment Table

Approximate Purge Valve Setting (number of turns to open)

Dryer	Purge Flow Rate [scfm]	Dryer Inlet Pressure				
		80 psig	90 psig	100 psig	110 psig	115 psig
XC 80	16	3.5	3.2	3.1	2.9	2.9
XC 100	20	4.0	3.8	3.7	3.6	3.5
XC 120	24	5.5	5.3	5.0	4.8	4.5
XC 160	32	5.9	5.7	5.5	5.4	5.4
XC 200	40	6.5	5.6	5.2	4.8	4.7
XC 250	50	7.0	6.5	6.0	6.0	5.5
XC 300	60	8.0	7.5	7.1	6.9	6.8
XC 400	80	3.6	3.5	3.3	3.2	3.1
XC 500	100	4.5	4.4	4.2	4.1	4.0
XC 800	160	6.2	4.9	4.7	4.6	4.5

Consult a factory representative for more information.

5. START-UP

5.1 Verification Prior to Start-up



Verify that the operating parameters match with the acceptable ranges indicated on the data plate of the dryer (voltage, frequency, air pressure, air temperature, ambient temperature, etc.). This is not the same as the ASME UW plate on the vessels and may be lower than what is stamped on the ASME UW plate.

Before delivery, each dryer is submitted to accurate tests simulating real operating conditions. Nevertheless, the unit could be damaged during transportation. Therefore, we suggest checking the integrity of the dryer upon arrival (see page 4) and observing the dryer during the first hours of operation.



The start-up must be performed by qualified personnel only. It is mandatory that the qualified person in charge will verify safe operational conditions complying with the local safety and accident prevention requirements.



The same qualified person will be responsible for the proper and safe operation of the dryer. Never operate the dryer if all panels are not properly in place or if any componentry is missing or appears damaged.



Service to be performed by qualified personnel only. The end user is responsible to ensure that the dryer will never be operated with pressure that exceeds the maximum pressure rating of the unit. Operating the dryer at a pressure higher than the maximum rating could be dangerous for both the operator and the machine.

The inlet air temperature and air flow rate entering the dryer must be within the limits indicated on the data plate.

Installation precautions must be taken in order to limit the vibration that can occur during the operation of the dryer. Therefore, we recommend using flexible connecting pipes that are able to insulate the dryer from possible vibrations originating from the pipe line.



The connection to the main power is to be carried out by qualified personnel, and the safety protocol must comply with local rules and laws.

Before connecting the unit to the electric power, verify that the voltage and the frequency available on the mains correspond to the data on the data plate of the dryer. In terms of voltage, a $\pm 5\%$ tolerance is acceptable. The wire size feeding the dryer must comply with the consumption of the dryer, while keeping into account also the ambient temperature, the conditions of the main power junction box, the length of the wire, and the requirements enforced by the National Electric Code.



It is mandatory to ensure the connection to the ground terminal.



The condensate is discharged at the same pressure as the air entering the dryer. Never point the condensate drain discharge towards anybody.

Connect and properly fasten the condensate drain to a collection system or container. The outlet condensate hose cannot be connected to pressurized systems.

DO NOT DISPOSE OF CONDENSATE INTO THE ENVIRONMENT



The condensate collected in the dryer contains oil particles released into the air stream by the compressor. Dispose of the condensate in a manner compliant with all local, state and Federal rules and regulations. We highly recommend the installation of either a QWIK-PURE® or ÖWAMAT® oil-water separator at the final collection point for all condensate discharge lines within the facility (i.e. from the main header).

5.2 Start-up Procedures



During the first start-up or start-up after a long period of inactivity or following maintenance, the technician must comply with the instructions below. The start-up must be performed by qualified personnel only.



The employee that operates the machine must wear hearing and eye protection before operating the dryer. Each employee must select a proper personal protection device (PPD) hearing protector such as earmuffs, ear canal caps or earplugs in order to prevent permanent hearing damage or loss.

Start-up Sequence

- + Please read and understand the entire manual before operating the dryer
 - + Verify the factory settings
 - + Verify the wiring diagrams that pertain to your unit and ensure the correct power supply is connected
- Do not energize the circuit at this time**
- + Verify that proper short circuit protection has been provided following all applicable codes and regulations
 - + Verify that all the steps of in the previous chapters relating to installation have been observed
 - + Verify that the connection to the compressed air system is correct
 - + Verify that the condensate drain pipe is properly fastened and connected to a collection system or container
 - + Remove any packaging and other material that might obstruct the area around the dryer

Before starting the dryer your compressor should be running, your compressed air system pressurized and the dryer bypassed and not yet pressurized.



1. With the dryer bypassed and in isolation (see page 14)
2. **SLOWLY** open the inlet isolation valve allowing compressed air into the dryer. It is critical that the dryer be pressurized slowly to prevent fluidization of the desiccant bed. Keep the outlet isolation valve closed at this time.
3. **SLOWLY** open the outlet isolation valve. All valves are now in their open positions and compressed air is flowing through both towers and downstream.
4. Close the dryer bypass valve. The bypass valve must be bubble tight to prevent any moisture from contaminating the dry air outlet from the dryer.
5. Plug in the dryer and energize the electrical circuit – the dryer is now ON.
6. Verify that the controller is on.
7. Check all piping for compressed air leaks.
8. Test the condensate drain on the pre-filter.
9. After 1-minute from start-up the adsorption tower B will be depressurized.
10. Wait for the dryer to make 10 full cycles (i.e. the depressurization from tower A to tower B).
11. The dryer will make the first 5 cycles short cycles, running at 50% run time without regard for dew point.
12. The pressure swing cycles occurs, every 5 minutes (outlet dew point of -40°F).

NOTE: During the first days in operation, the dew point cannot be guaranteed because the adsorption material can contain humidity from storage. At the first start-up or start-up after a long inactivity period or following maintenance shutdowns, we recommend operating the dryer at a reduced nominal flow of 50% during the first two days.

5.3 General Operation

- + The dryer may require up to 48-hours of operation to reach normal operating outlet dew point. Therefore, indicators and alarms do not need to be recognized during this time. Applications where a dew point lower than -40 °F is needed, may require additional time to reach equilibrium.
- + The dryer will not perform without properly sized and installed pre-filtration, condensate drainage and correct purge flow adjustment.
- + After the initial start-up some dusting may occur. This is normal and will diminish with time, although may accelerate the first maintenance interval of the exhaust valves, exhaust silencers and post-filter element.
- + Exhaust valves and silencers may have to be cleaned due to dusting from shipping and the initial start-up, and should be cleaned regularly to ensure proper operation. Post-filter elements should also be part of a regular preventative maintenance schedule.
- + Never service the dryer or filters without first relieving pressure from the dryer.
- + A desiccant dryer should never be pressurized or depressurized suddenly. This will cause degradation and dusting of the desiccant bed.
- + The dryer is designed for a maximum operating pressure of 150 psig as standard.

6. ISOLATION AND SHUT DOWN PROCEDURES



Users operating the machine must wear hearing and eye protection. Each employee must select a proper personal protection device (PPD) hearing protector such as earmuffs, ear canal caps or earplugs in order to prevent permanent hearing damage or loss.



Isolation

1. Allow the dryer to reach its re-pressurization step and fully re-pressurize.
2. Once fully re-pressurized, remove power from the dryer.
3. Open the bypass valve.
4. Close the outlet isolation valve.
5. Close the inlet isolation valve.



Depressurization and Shut Down

1. Open the bypass valve.
2. Close the outlet isolation valve.
3. Close the inlet isolation valve.
4. Allow the dryer to continue to run. During the normal operating cycle both towers will blow down and depressurize.
5. Disconnect the power to the dryer.
6. Open the manual ball valves on any filters with manual ball valves to allow full depressurization. Also, leave manual ball valves on filter open during maintenance and service.



IMPORTANT! Always remove all pressure and disconnect all power before servicing the dryer.



To restart the dryer, follow the start-up procedure in Section 5. START-UP

7. CONTROLLER INFORMATION AND OPERATION

7.1 Display Overview

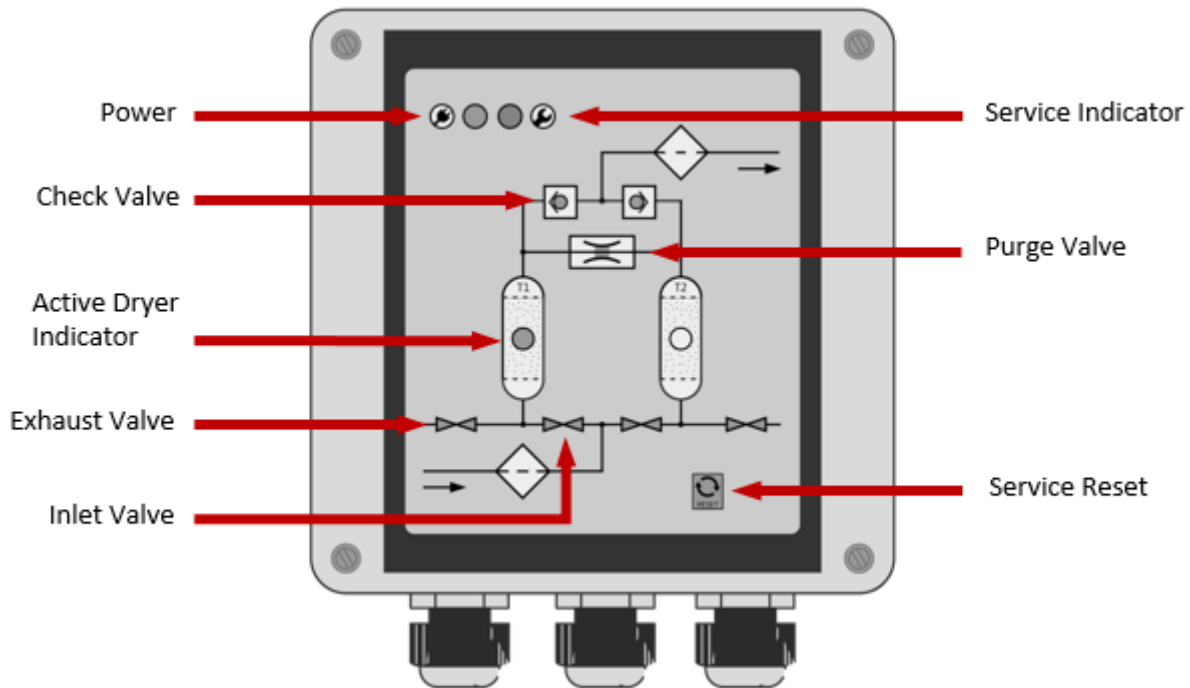

The LED illuminated PID controller interfaces between the dryer and the operator (shown above). The following pages the detailed information about the controller's settings and operation.

The controller has a total of nine LEDs to inform the operator its step in operation:

- + Two check valves indicating the direction of air flow out of the dryer
- + One purge valve indicator used during regeneration
- + Two LEDs are used to indicate the active dryer tower during operation
- + Four LEDs indicate purge exhaust valve and inlet valve PV- and IV-

The controller has two additional LEDs used to indicate power and service in the upper left corner of the display as shown by the corresponding icons. During normal operation, the power LED is green and the service indicator LED is off.

7.2 Controller Startup

It is important to note that the controller is programmed to run five times in succession for a short cycle. That is a 50% shorter run times without consideration of the dew point input to bring the dryer to a defined state. After this startup procedure the device is in normal operation mode.

During startup the compressor synchronization input is also active.

7.3 Controller Inputs

The controller and housing provide three M12 and two M16 glands on for its input / output connection lines. For input, the connections are:

- + Power cable
- + Compressor-synchronization signal

The input “compressor synchronization”, is meant to synchronize the dryer with switching ON and OFF of the compressor. Hence, it prevents a situation where the dryer continues to operate and use rinsing air from the compressed air network though there is no supply of compressed air. In case the voltage (120V AC-Input) drops at the input, the purge exhaust valve is immediately closed.

After the compressor signal comes back online, the drying cycle is continued from the same point, meaning that the last open valve also opens again. Note two exceptions:

- + This is not valid if the remaining regeneration time is less than 30 seconds, in which case it immediately switches over to the other drying column, which means the other valve is opened.
- + If the compressor is switched off for more than 24 hours, then the device is started with five short full Nema cycles as though the operating voltage has been interrupted (i.e. as after RESET).

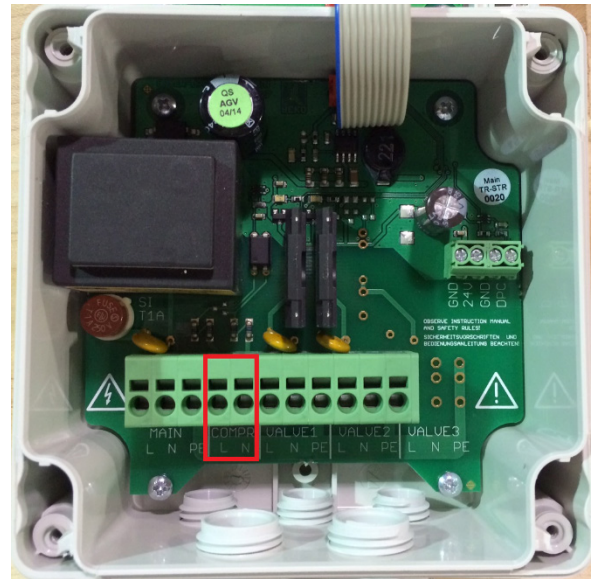

7.4 Controller Outputs

The controller outputs information two ways, one, to the controller display, the other, to the dryer system through the housing glands:

- + Purge Exhaust Valve A
- + Purge Exhaust Valve B

The controller outputs the dryer’s operational step to the controller display LED indicators. This indicates the activated valves and drying tower. In addition, the power light and service indicator are displayed.

The controller outputs an electrical signal to the tower selector solenoid valve and energizes the appropriate valves based on dryer’s step of operation.

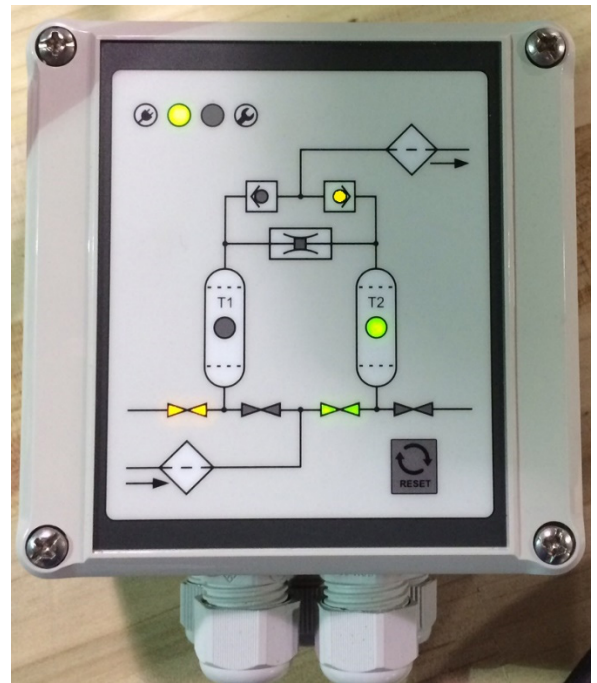

7.5 Controller Settings

The controller unit has a total of eight DIP switches with the following parameters:

- + Three DIP switches are used to set the tower regeneration time
- + Two DIP switches are used to set the pressure build-up time
- + One DIP switch used for future expansion
- + One DIP switch aligns the controller with the compressor sync
- + One DIP switch used for future expansion

Below is a picture of the DIP switch control interface:



The controller's eight DIP switches are detailed in the following section. These switches are adjustable but should only be done so by a qualified person.

7.5.1 Regeneration Time (1, 2, 3)

The regeneration time is the time selected for steps 1-2 detailed in Section 3.5. The three DIP switches can be adjusted to eight (8) selection times between 2.5 and 6 minutes in increments of 30-seconds as follows:

- + 000 2.5 minutes
- + 100 3.0 minutes
- + 010 3.5 minutes
- + 110 4.0 minutes (factory setting)
- + 001 4.5 minutes
- + 101 5.0 minutes
- + 011 5.5 minutes
- + 111 6.0 minutes

7.5.2 Re-Pressure Build-Up Time (4, 5)

The re-pressure build-up time is the time selected for step 3 in Section 3.5. The two DIP switches can be adjusted to four (4) regeneration times between 60 and 120 seconds in 20-second increments as follows:

- + 00 60 seconds (factory setting)
- + 10 80 seconds
- + 01 100 seconds
- + 11 120 seconds

7.5.3 Expansion (6)

This DIP switch is not currently in use and should be set to OFF, '0'.

7.5.4 Compressor Sync (7)

The compressor sync to the controller is detailed in section 7.3. It can be set to either to an 'ON' or 'OFF' position.

- + 0 OFF - compressor is synced
- + 1 ON - compressor not synced (factory setting)

7.5.6 Expansion (8)

This DIP switch is not currently in use and should be set to OFF, '0'.

7.5.7 Factory Default Settings

The factory default settings of the DIP switches are as follows:

- Purge Air Time** 4.0 minutes (1, 1, 0)
- Re-Pressure Build-Up** 60 seconds (0, 0)
- Expansion** OFF (0)
- Compressor Sync** ON (1)
- Expansion** OFF (0)

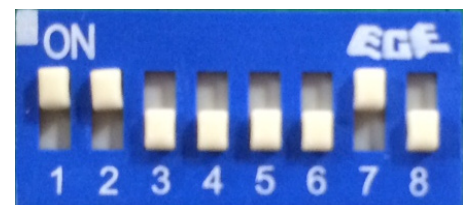

7.6 Service Reset Button



Disconnect dryer from power. With the dryer disconnected from the power source press the reset button and hold it and plug the dryer back in to its power source. After that the timer is reset to 8000 hrs.



After 360-days of the service indicator LED will flash amber indicating that service is due, and after 400-days the LED will flash red indicating that service is overdue.

7.7 Power Requirements

The controller operates on 100-120VAC / 50-60Hz. The units are shipped with an installed standard US 120 volt cord for convenience. Before starting up the machine it is necessary to have a qualified electrician review the electrical requirements schematic and install to the National Electric Code. Please refer to Section 12.



The optional BEKOMAT® on the pre-filter at the dryer inlet is supplied according to the power voltage indicated in the order; verify its compatibility with the information given on the type plate.

8. MAINTENANCE AND SERVICE

8.1 Routine Maintenance



The service must be carried out only by a qualified technician.



Before any service is carried out, always verify that:

- + **The power has been disconnected following proper Lock-out, Tag-out procedures**
- + **Depressurize the unit and ensure the unit is isolated from the compressed air system (see sect. 6)**

DAILY



- + Check that pre-filter condensate drain is working properly
- + Check the differential pressure of any installed pre and post filtration
- + Check that the tower switching operation takes place correctly at the set cycle times.
- + Check that the tower pressure gauge of the regenerating tower reads 0 psig while the drying tower reads full line pressure

ANNUALLY



- + Replace the pre and post filter elements
- + Replace the exhaust silencers
- + Replace the pre-filter float drain or BEKOMAT® service unit
- + Check if the solenoid valves are working properly
- + Check if all screws of the electrical wiring are securely tightened
- + Verify operation of the dryer

EVERY 2 YEARS



In addition to the scheduled annual maintenance:

- + Install inlet and purge exhaust valve service kit
- + Verify operation of the dryer

EVERY 2 YEARS



In addition to the scheduled annual maintenance:

- + Replace the desiccant adsorption material in both towers
- + The estimated average lifespan of the adsorption material is 3-5 years when using 10-minute cycle times or 3,000 operating hours per year. In all cases, the lifetime of desiccant material is heavily dependent on the quality and temperature of the inlet air and ensuring that scheduled maintenance is consistently carried out.
- + Verify operation of the dryer

8.2 Maintenance and Service Intervals

Preventative maintenance of the pre- and post-filter element, and desiccant material is required.

The controller monitors the dryers operating hours and will activate the maintenance alarms after the following intervals:

- + 360 Days: Amber Service Light
- + 400 Days: Red Service Light

The dryer system should be checked for items that require standard replacement and maintenance such as: the filter elements, exhaust silencers, and desiccant material.

NOTE: The maintenance alarms (reminders) do not change the operation of the controller in any way.

8.3 Fuses

One safety fuse is fitted on the electronic board, in position F1. The fuse protects all circuits on the electronic board of the BEKOMINI controller. The replacement fuse type is:

- + T1A type Radial lead fuse, PCB style



The fuse can break if there are any problems with the dryer. In which case, only a certified technician can replace the fuse, but only after solving the problem that caused the malfunction first. Refer to Section 9, 'TROUBLESHOOTING GUIDE'.

8.4 Desiccant Replacement



CAUTION: Activated alumina desiccant dust is considered a nuisance dust. Proper precautions should be taken prior to replacing the desiccant material in the dryer. Please refer to the Safety Data Sheet (SDS).



1. Isolate and shut down the dryer.
2. Place a suitable container at the edge of each drain port on the bottom of the towers that are located on the sides, facing outward.
3. Open the drain ports on the bottom of the towers and catch the desiccant in the containers.
4. Refill each tower with the recommended type, size and quantity of desiccant. Only use manufacturer supplied desiccant, which is high quality, high capacity desiccant designed and sized for the dryers.
5. Carefully knock on the sides of the tower chambers while filling so that the desiccant will pack tightly. Some settling may be required in order to fit the specified fill amount into the tower. Tank sizes may be the same for multiple models, so do not be concerned if the tower is not entirely full.
6. Desiccant that has been contaminated with oil or other substances may require different disposal methods and procedures than desiccant that is being replaced due to aging. Consult the appropriate MSDS and follow all applicable laws and regulations regarding disposal.

8.5 Inlet and Exhaust Valve Repair



1. Isolate and shut down the dryer.
2. Make certain that there are no “pockets” of pressure contained by the various valves.
3. Open the bleed valve on the bottom of the control air filter housing.
4. Loosen the “one touch” pneumatic fitting (no tools required) that attaches the control air tubing to the valve body. Carefully move the tubing aside and out of the way. We suggest
5. Disassemble the valve for cleaning or repair. Service kits are available for all valves.
6. Reassemble the valve and ensure that all O-rings, gaskets and components have been reassembled or replaced accordingly.

9. TROUBLESHOOTING GUIDE



The troubleshooting and the eventual checks must be performed by qualified personnel only.



The technician that services the machine must wear hearing and eye protection while servicing the dryer. Each employee must select a proper personal protection device (PPD) hearing protector such as earmuffs, ear canal caps or earplugs in order to prevent permanent hearing damage or loss.

SYSTEM TROUBLE	POSSIBLE CAUSE	SUGGESTED ACTION
❖ The service LED  on the controller is flashing amber or red.	<ul style="list-style-type: none"> ⇒ Service Reminder ⇒ Service Due 	<ul style="list-style-type: none"> ⇒ If the service LED indicator light is flashing amber this is an indication that the dryer is approaching the annual maintenance interval, and schedule maintenance should be performed within the next 5-days. – 360 hours ⇒ If the service LED indicator light is flashing red then the dryer is overdue for scheduled maintenance by approximately one month, and should be serviced immediately to ensure trouble free operation. – 400 hours
❖ Dryer stopped	<ul style="list-style-type: none"> ⇒ No power ⇒ Valve problem ⇒ No pilot control air ⇒ Solenoid valves ⇒ Controller ⇒ Compressor off 	<ul style="list-style-type: none"> ⇒ Check power and electric ⇒ Check the operation of inlet and purge exhaust valves ⇒ Ensure Control pilot air is delivering at 80 psi ⇒ Ensure DIN connectors are properly attached to solenoid valves ⇒ See controller troubleshooting ⇒ Check if compressor Sync is commanding dryer off
❖ All the inlet air is discharged through the silencers	<ul style="list-style-type: none"> ⇒ Faulty inlet valve ⇒ Faulty signal ⇒ Faulty Outlet valve ⇒ Pneumatic 	<ul style="list-style-type: none"> ⇒ The inlet valves are blocked – open and clean ⇒ The controller continuously supplies solenoid valve PVA and/or PVB – check the electric wiring and if necessary replace ⇒ Outlet Check valve(s) stuck open – serviceable only by qualified technician ⇒ Ensure tube routing matches diagram
❖ Liquid comes out of the silencers	<ul style="list-style-type: none"> ⇒ High dew point ⇒ Overloaded ⇒ No power ⇒ Flow control valve ⇒ No pilot control air ⇒ Exhaust Silencers 	<ul style="list-style-type: none"> ⇒ Ensure operation sequence and purge setting ⇒ Check capacity versus operating conditions ⇒ Check purge exhaust valve for normal operation ⇒ Ensure that the purge exhaust valve actuators is not closed ⇒ Ensure pilot air reading is 80 psi ⇒ Replace silencer filter elements if clogged
❖ Repressurization	<ul style="list-style-type: none"> ⇒ Purge Exhaust Valve ⇒ Purge line ⇒ Purge Valve ⇒ Inlet Valve 	<ul style="list-style-type: none"> ⇒ See purge Exhaust Valve troubleshooting ⇒ Purge setting or clog, full open purge valve to clean out and then set according to table xx ⇒ See Purge valve troubleshooting ⇒ See Inlet Valve Failure troubleshooting

SYSTEM TROUBLE	POSSIBLE CAUSE	SUGGESTED ACTION
❖ High Dewpoint (as checked by external sensor)	<ul style="list-style-type: none"> ⇒ Purge Valve ⇒ Exhaust Silencers ⇒ Desiccant ⇒ Purge Exhaust Valve ⇒ Low Pressure ⇒ High Flow ⇒ High Temperature ⇒ Inlet Valve ⇒ Power ⇒ Controller 	<ul style="list-style-type: none"> ⇒ Adjust and ensure correct setting ⇒ Backpressure due to clog, install new mufflers ⇒ Media is fouled, replace new ⇒ See Purge Exhaust Valve troubleshooting ⇒ Increase to rated pressure ⇒ ensure air inlet flow does not exceed dryer capacity ⇒ ensure air inlet temperature does not exceed dryer capacity ⇒ See Inlet Valve troubleshooting ⇒ Ensure that the controller has correct voltage ⇒ See controller troubleshooting
❖ High Pressure Drop	<ul style="list-style-type: none"> ⇒ Desiccant ⇒ Pre-filter ⇒ Post-filter ⇒ Capacity ⇒ Desiccant screens ⇒ Purge Exhaust valve 	<ul style="list-style-type: none"> ⇒ Replace fouled desiccant ⇒ Contaminated inlet pre-filter, replace ⇒ Contaminated outlet post- filter, replace ⇒ Overflow, ensure air inlet flow does not exceed dryer capacity ⇒ Remove desiccant/screens and clean screens ⇒ See purge exhaust troubleshooting
❖ Back pressure	<ul style="list-style-type: none"> ⇒ Purge muffler fouled ⇒ Vessel screen ⇒ Restricted purge piping ⇒ Bad Purge Exhaust Valve 	<ul style="list-style-type: none"> ⇒ Replace with new ⇒ Empty towers, remove screens and clean ⇒ Clean ⇒ See purge Exhaust Valve troubleshooting
COMPONENT TROUBLE	POSSIBLE CAUSE	SUGGESTED ACTION
❖ Purge control Valve	<ul style="list-style-type: none"> ⇒ Setting ⇒ Damaged ⇒ Dirty 	<ul style="list-style-type: none"> ⇒ ensure proper setting from table xx ⇒ replace valve ⇒ open full for clean out or dismantle and clean
❖ Purge Exhaust Valve	<ul style="list-style-type: none"> ⇒ Worn seals ⇒ Pneumatic ⇒ Electrical ⇒ Restriction 	<ul style="list-style-type: none"> ⇒ Install service kit ⇒ check pilot valve, pilot air supply, pilot air filter, flow control valve on actuator ⇒ Check power to solenoid valves ⇒ Backpressure – silencers or mufflers are clogged, install new muffler elements
❖ Inlet Valve	<ul style="list-style-type: none"> ⇒ Worn seals ⇒ Pneumatic ⇒ Electrical ⇒ Restriction 	<ul style="list-style-type: none"> ⇒ Install service kit ⇒ check pilot valve, pilot air supply, pilot air filter, flow control valve on actuator ⇒ Check power to solenoid valves ⇒ Backpressure – silencers or mufflers are clogged, install new muffler elements
❖ Outlet Check Valve	<ul style="list-style-type: none"> ⇒ Restriction ⇒ Damaged Seal 	<ul style="list-style-type: none"> ⇒ SERVICEABLE ONLY BY QUALIFIED TECHNICIAN
❖ Drain	<ul style="list-style-type: none"> ⇒ Application ⇒ Electrical 	<ul style="list-style-type: none"> ⇒ Overloaded with water, check pre-filter and upstream bulk water separator ⇒ Check electrical connections

COMPONENT TROUBLE	POSSIBLE CAUSE	SUGGESTED ACTION
❖ Drain	⇒ Contaminated ⇒ Drain	⇒ Clean drain and plumbing ⇒ Install service drain kit or replace entire unit
❖ Pre-Filter	⇒ Application ⇒ Dirty element ⇒ Electrical ⇒ Differential pressure gauge	⇒ Failure with upstream bulk water separator ⇒ Contaminated filter, replace element ⇒ Faulty electrical signal ⇒ Clean, check and or replace
❖ Post-Filter	⇒ Dryer dusting ⇒ Dirty element ⇒ Electrical ⇒ Differential pressure gauge	⇒ Ensure proper dryer sequence ⇒ Contaminated filter, replace element ⇒ Faulty electrical signal ⇒ Clean, check and or replace
❖ Controller	⇒ Defective ⇒ No power supply ⇒ Loose connection	⇒ Replace controller ⇒ Ensure voltage supply ⇒ Check connections
❖ Relief Valve	⇒ Over pressure ⇒ Leak ⇒ Over temperature	⇒ Check system pressure and correct ⇒ Replace valve ⇒ Ensure system temperature or fire has not occurred
❖ Solenoid	⇒ Electrical ⇒ Pneumatic ⇒ Defective	⇒ Ensure connections and signal are adequate ⇒ Ensure pilot supply is good and valve is clean ⇒ Replace with new

10. MAINTENANCE AND SPARE PARTS

We strongly recommend stocking the suggested spare parts to help enable you to promptly carry out any required maintenance and/or replace any parts that may fail without having to wait for the parts to be delivered. If you need to replace any other parts, please contact your local distributor or BEKO Technologies, Corp. Technical Service Department at +1 (800) 235-6797 for assistance.

10.1 Required Maintenance Parts

Interval	DESCRIPTION	Order No.	080	100	120	160	200	250	300	400	500	650	800	
Annual	<i>Pre-filter Element 0.01 µm</i>													
	07SX	4038113	◆	◆	◆									
	10SX	4038149				◆								
	12SX	4038114					◆							
	15SX	4038115						◆						
	18SX	4038150							◆					
	20SX	4038151								◆	◆			
	25SX	4038116										◆	◆	
	<i>Post-filter Element 1.0 µm</i>													
	07FX	4038106	◆	◆	◆									
	10FX	4038140				◆								
	12FX	4038107					◆							
	15FX	4038108						◆						
	18FX	4038141							◆					
	20FX	4038142								◆	◆			
	25FX	4038109										◆	◆	
	<i>Exhaust Silencer</i>													
	¾" Exhaust Silencer	4020833	◆		2									
	1" Exhaust Silencer	4020834		◆			2							
	1¼" Exhaust Silencer	4026420							2	2				
	1½" Exhaust Silencer	4020835				◆						2		
	2" Exhaust Silencer	4020836						◆					2	2
	<i>Float Drain for CLEARPOINT® (Standard)</i>													
	FAD050 Float Drain	4025536	◆	◆	◆	◆	◆	◆	◆	◆	◆	◆	◆	◆
	<i>Service Unit for CLEARPOINT® with BEKOMAT® (Optional)</i>													
BEKOMAT® 31 Service Unit	4023608	◆	◆	◆	◆	◆	◆	◆	◆	◆	◆	◆	◆	
BEKOMAT® 32 Service Unit	4025061	-	-	-	-	-	-	-	-	-	-	-	-	
2 Years	<i>Inlet Angle Body Valve / Actuator Only</i>													
	¾" Inlet Valve / Actuator	4020801 / 4027892	◆											
	1" Inlet Valve / Actuator	4020803 / 4027893		◆	◆									
	1¼" Inlet Valve / Actuator	4026417 / 4027894				◆	◆							
	1½" Inlet Valve / Actuator	4020805 / 4027895						◆	◆					
	2" Inlet Valve / Actuator	4020807 / 4027896								◆	◆			
2½" Inlet Valve / Actuator	4032458 / 4027897										◆	◆		

Interval	DESCRIPTION	Order No.	080	100	120	160	200	250	300	400	500	650	800		
2 Years	<i>Exhaust Angle Body Valve / Actuator Only</i>														
	¾" Exhaust Valve / Actuator	4020800 / 4027887	◆	◆	◆										
	1" Exhaust Valve / Actuator	4020802 / 4027888				◆	◆								
	1¼" Exhaust Valve / Actuator	4026416 / 4027889						◆	◆	◆					
	1½" Exhaust Valve / Actuator	4020804 / 4027890									◆	◆			
	2" Exhaust Valve / Actuator	4020806 / 4027891												◆	
	<i>Service Seal Kit</i>														
	¾" Service Seal Kit	4027898	-	-	-	-	-	-	-	-	-	-	-	-	-
	1" Service Seal Kit	4027899	-	-	-	-	-	-	-	-	-	-	-	-	-
	1¼" Service Seal Kit	4027900	-	-	-	-	-	-	-	-	-	-	-	-	-
	1½" Service Seal Kit	4027901	-	-	-	-	-	-	-	-	-	-	-	-	-
	2" Service Seal Kit	4027902	-	-	-	-	-	-	-	-	-	-	-	-	-
	2½" Service Seal Kit	4027903	-	-	-	-	-	-	-	-	-	-	-	-	-
3 Years	<i>Desiccant Adsorption Material</i>														
	¾" Activated Alumina (total weight in lbs. per dryer)	4027023	132	167	167	262	262	384	384	539	715	917	1114		

10.1 Spare Parts

DESCRIPTION	Order No.	080	100	120	160	200	250	300	400	500	650	800
<i>Inline Check Valve (Outlet)</i>												
¾" Outlet Poppet Check Valve	4020820	◆										
1" Outlet Poppet Check Valve	4020822		◆	◆								
1¼" Outlet Poppet Check Valve	4026421				◆	◆						
1½" Outlet Poppet Check Valve	4020821						◆	◆				
2" Outlet Poppet Check Valve	4020823								◆	◆		
2½" Outlet Poppet Check Valve	4020816										◆	◆
<i>Pressure Relief Safety Valve</i>												
¼" Pressure Relief Safety Valve	4026666	◆	◆	◆								
½" Pressure Relief Safety Valve	4026667				◆	◆						
¾" Pressure Relief Safety Valve	4026668						◆	◆	◆	◆		
1" Pressure Relief Safety Valve	4026669										◆	◆
<i>Purge Flow Control Valve</i>												
½" Purge Flow Control Valve	4020764	◆	◆	◆	◆							
¾" Purge Flow Control Valve	4020765					◆	◆	◆				
1" Purge Flow Control Valve	4020766								◆	◆	◆	◆
<i>Electronic Controller</i>												
BEKOMINI Electronic Controller / PLC	4026540	◆	◆	◆	◆	◆	◆	◆	◆	◆	◆	◆
<i>Solenoid Valve Assembly</i>												
*Complete Solenoid Valve Assembly	4054522	◆	◆	◆	◆	◆	◆	◆	◆	◆	◆	◆
<i>Tower Pressure Gauge</i>												
2½" 0-160 psig Pressure Gauge Economy	4026663	◆	◆	◆	◆	◆	◆	◆	◆	◆	◆	◆
Gauge Clamp	4026665	◆	◆	◆	◆	◆	◆	◆	◆	◆	◆	◆
<i>FRL Combo Package</i>												
¼" 20-130 psig Filter Regulator Combo	4026419	◆	◆	◆	◆	◆	◆	◆	◆	◆	◆	◆
<i>Pilot Air Filter Element</i>												
Replacement Filter Element for FRL Combo	4038241	◆	◆	◆	◆	◆	◆	◆	◆	◆	◆	◆
<i>Brass Cone Silencer</i>												
Replacement Brass Cone Silencer	4026418	◆	◆	◆	◆	◆	◆	◆	◆	◆	◆	◆
<i>On / Off Switch</i>												
Replacement On / Off Switch	4026722	◆	◆	◆	◆	◆	◆	◆	◆	◆	◆	◆
<i>Pressure Switch</i>												
Replacement Pressure Switch	on request	◆	◆	◆	◆	◆	◆	◆	◆	◆	◆	◆
<i>Tube Fitting Package</i>												
Replacement Tube Fitting Package	on request	◆	◆	◆	◆	◆	◆	◆	◆	◆	◆	◆
<i>Speed Control</i>												
Replacement Speed Control	4027427	◆	◆	◆	◆	◆	◆	◆	◆	◆	◆	◆
<i>Tower Screen</i>												
Replacement Tower Screen	on request	◆	◆	◆	◆	◆	◆	◆	◆	◆	◆	◆

NOTE: *For Serial Numbers up to and including 15328807, use Order No. 4024046.

When inquiring about any other part always indicate the data listed on the identification plate.

11. DISMANTLING OF THE DRYER

If the dryer is to be dismantled and disposed of then it must be split into groups of materials of construction.

Part	Material
Desiccant material	Activated alumina, Oil contaminated
Frame and supports	Carbon steel, Powder coated
Piping	Galvanized steel, Galvanized malleable iron, Brass, Aluminum
Towers and screens	Carbon steel, Stainless steel
Valves	Brass, Stainless steel, Bronze, Plastic
Filter housing	Aluminum, Epoxy paint
Filter cartridge	Filtering material, PVC, Oil
Solenoid valve	Bronze, Steel, Techno-polymer, PVC
Condensate Drain	PVC, Aluminum, Steel, Bronze
Silencers	Aluminum, Stainless steel
Safety Valves	Brass, Bronze
Gaskets and O-Ring	Graphite, Synthetic elastomer
Electric cables	Copper, PVC
Electric Parts	PVC, Copper, Bronze, Silicon



We recommend complying with the safety rules and regulations for the disposal of each type of material. The adsorption material and the filter cartridge will contain droplets of lubrication oil. Do not dispose of these materials in the environment. All local Governmental laws and regulations must be followed in disposing of the above listed materials.

12. ELECTRICAL WIRING DIAGRAM

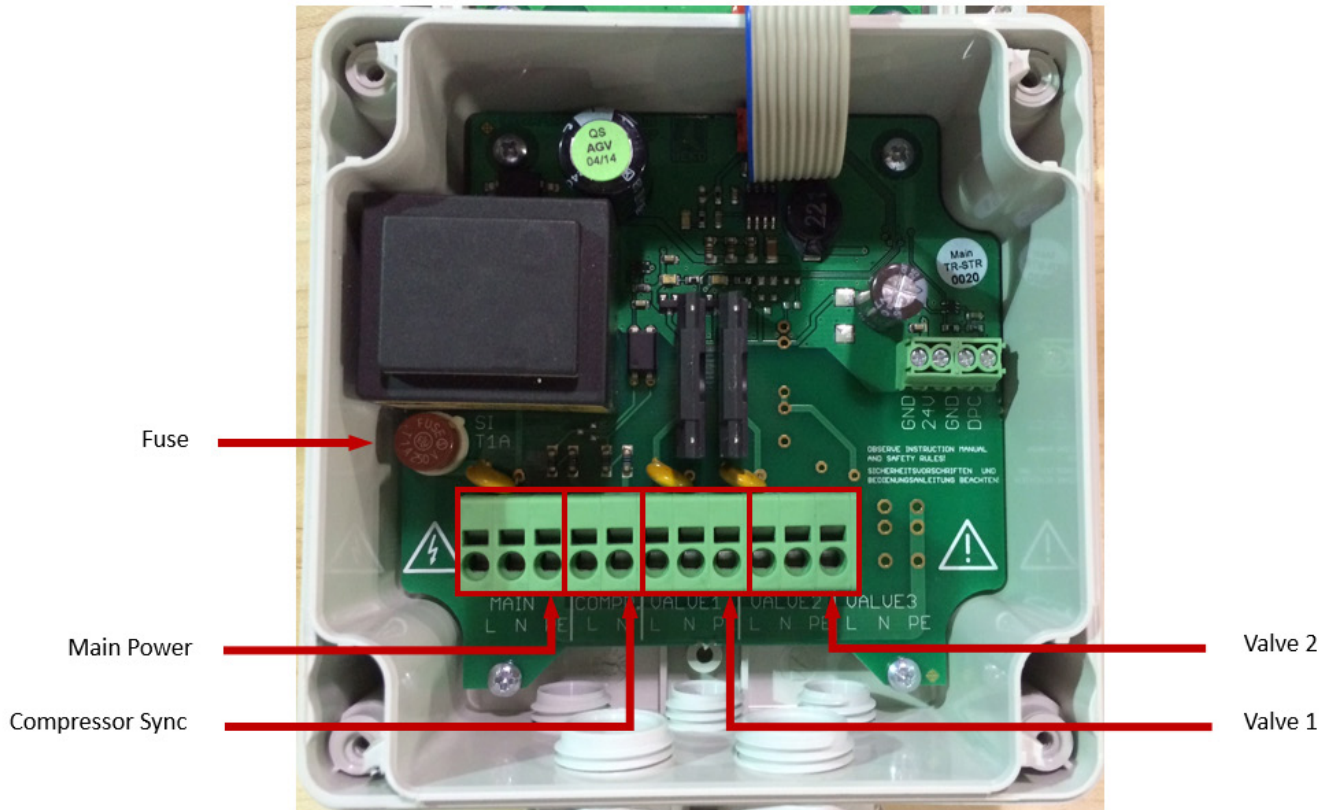

13. GENERAL DESCRIPTION OF PARTS

- + **Desiccant** – An adsorbent used for drying air or gases. The proper quantity, size and type are necessary.
- + **Inlet Valve** – Normally open air operated switching valves used to direct air flow through the towers.
- + **Exhaust Valve** – Normally closed air operated switching valves used to exhaust purge air, hold air in the on-line tower and exhaust air from the tower ready to be regenerated.
- + **Outlet and Check Valves** – Valves that allow full flow in one direction and no flow in the opposite direction. These valves are used in conjunction with the inlet and exhaust valves to control the desired flow of process air through the dryer.
- + **Safety Relief Valves** – Valves on each tower to protect the vessels from overpressure situations. The setting is indicated on each valve.
- + **Purge Exhaust Silencer** – Installed to reduce exhaust noise during purge and blow down for the protection all personnel and to comply with OSHA standards. Silencers are non-mechanical, but must be maintained.
- + **Purge Flow Control Valve** – Valve that allows the adjustment and regulation of purge air flow used for the regeneration process.
- + **BEKOMIN Controller** – Electronic controller that provides an interface between the operator and dryer, provides dryer cycle status, operates the electric solenoid valves, provides indicator lights and alarm controls. All hard wired connections, including the power connections during installation are made to this device.
- + **Electric Solenoid** – An electromechanical device used for controlling the flow of liquid or gas.

For technical product support please call +1 (800) 235-6797 and select Option 2

The product categories

 **Condensate drainage**
BEKOMAT®

 **Filtration**
CLEARPOINT®

 **Measurement technology**
METPOINT®

 **Condensate processing**
ÖWAMAT® | QWIK-PURE® | BEKOSPLIT®

 **Drying**
DRYPOINT®

 **Process technology**
BEKOKAT®



BEKO TECHNOLOGIES CORP.
900 Great Southwest Pkwy SW
Atlanta, GA 30336
USA

Phone +1 (404) 924-6900
Fax +1 (404) 629-6666

beko@bekousa.com
www.bekousa.com

