



EN-US - english

Instructions for installation and operation

Mobile hand-held measuring device

METPOINT® BDL portable



Dear customer,

Thank you for deciding in favor of the **METPOINT® BDL portable**. Please read these installation and operating instructions carefully before mounting and starting up the device and follow our directions. Perfect functioning and safe operation of the **METPOINT® BDL portable** can only be guaranteed when the provisions and notes stipulated here are strictly adhered to.

Contents

| | | |
|--------------|---|----|
| 1 | Pictograms and symbols | 5 |
| 2 | Signal words in accordance with ISO 3864 and ANSI Z 535..... | 5 |
| 3 | Safety instructions | 6 |
| 4 | Field of application | 7 |
| 5 | Proper use | 7 |
| 6 | Type plate/product identification | 8 |
| 7 | Storage and transport | 9 |
| 8 | Technical data METPOINT® BDL portable | 10 |
| 9 | Input signals ext. sensor METPOINT® BDL portable..... | 11 |
| 10 | Installation | 12 |
| 10.1 | Line cross-sections..... | 12 |
| 11 | Connection diagrams of the different sensor types..... | 13 |
| 11.1 | PIN assignment for the sensor connection | 13 |
| 11.2 | Connection dew point sensors DP series | 14 |
| 11.3 | Connection dew point sensors DP/FS series..... | 14 |
| 11.4 | Connection dew point sensors SD series | 14 |
| 11.5 | Connection pulse sensors..... | 15 |
| 11.6 | Analogue 2-wire, 3-wire, and 4-wire current signal..... | 16 |
| 11.7 | 3 and 4-wire voltage supply 0 - 1/10/30 VDC | 17 |
| 11.8 | 2, 3, and 4-wire terminal assignment of PT100/PT1000/KTY81..... | 18 |
| 11.9 | Assignment with RS485 | 18 |
| 12 | Operation METPOINT® BDL portable | 19 |
| 12.1 | Membrane keyboard | 19 |
| 12.1.1 | On and off key | 19 |
| 12.1.2 | Brightness keys | 19 |
| 12.1.3 | Screenshot button | 19 |
| 12.1.3.1 | Storing a screenshot..... | 19 |
| 12.1.3.2 | Exporting screenshots | 20 |
| 12.2 | Touch panel..... | 22 |
| 12.3 | Main menu (home) | 23 |
| 12.3.1 | Initialization..... | 23 |
| 12.3.2 | Main menu..... | 24 |
| 12.3.2.1 | Settings | 25 |
| 12.3.2.1.1 | Password setting..... | 25 |
| 12.3.2.1.2 | Sensor settings | 26 |
| 12.3.2.1.2.1 | Selection of the ext. sensor type (example: BEKO digital sensor type)..... | 27 |
| 12.3.2.2 | Denoting the measuring data and determining the resolution of the decimal places..... | 30 |
| 12.3.2.2.1 | Recording measuring data | 30 |
| 12.3.2.2.1.2 | Alarm settings (alarm pop-up) | 31 |
| 12.3.2.2.1.3 | Advanced settings (scaling analogue output) | 32 |
| 12.3.2.3 | Dew point sensor with the BEKO digital type | 33 |
| 12.3.2.3.1 | Marking and setting text fields..... | 34 |
| 12.3.2.3.1.2 | Configuration of analogue sensors | 37 |
| 12.3.2.3.1.3 | Types 0 - 1/10/30 Volt and 0/4 – 20 mA..... | 37 |
| 12.3.2.3.1.4 | Types PT100x and KTY81 | 39 |
| 12.3.2.3.1.5 | Type pulse (pulse value) | 40 |

| | | |
|----------------|--|----|
| 12.3.2.3.1.6 | Type no sensor | 42 |
| 12.3.2.3.1.7 | Type Modbus | 43 |
| 12.3.2.3.2 | Selection and activation of the sensor type | 43 |
| 12.3.2.3.2.1.1 | General Modbus settings | 43 |
| 12.3.2.3.3 | Modbus settings for the METPOINT® SD23 | 47 |
| 12.3.2.3.4 | Data logger settings | 49 |
| 12.3.2.3.5 | Device settings | 53 |
| 12.3.2.3.5.1 | Language | 53 |
| 12.3.2.3.5.2 | Date & time | 54 |
| 12.3.2.3.5.3 | SD card | 55 |
| 12.3.2.3.5.4 | System update | 56 |
| 12.3.2.3.5.4.1 | Securing the device settings | 56 |
| 12.3.2.3.5.4.2 | Check for available updates (USB) | 57 |
| 12.3.2.3.5.4.3 | Loading device settings | 58 |
| 12.3.2.3.5.5 | Reset factory defaults | 59 |
| 12.3.2.4 | Calibrating the touch screen | 60 |
| 12.3.2.4.1 | Brightness | 60 |
| 12.3.2.4.2 | Cleaning | 61 |
| 12.3.2.4.3 | System overview | 61 |
| 12.3.2.4.4 | About METPOINT® BDL portable | 61 |
| 12.3.2.5 | Graphics | 62 |
| 12.4 | Graphics/current values | 66 |
| 12.4.1.1 | Channels | 68 |
| 12.4.1.1.1 | Min./max. function | 68 |
| 12.4.1.2 | Current values | 70 |
| 12.4.1.3 | Alarm overview | 71 |
| 12.4.1.4 | Export data | 72 |
| 13 | Virtual channels (optional) | 74 |
| 13.1 | Activate the option "virtual channels" | 74 |
| 13.2 | Virtual channels setting | 75 |
| 13.2.1 | Selection of the sensor type | 75 |
| 13.2.2 | Configuration of the individual virtual values | 76 |
| 13.2.3 | Activation of the individual virtual values | 76 |
| 13.2.4 | Definition of the operands | 76 |
| 13.2.5 | Definitions of the operations | 78 |
| 13.2.6 | Definition of the unit | 78 |
| 13.2.7 | Resolution of the decimal places – designating and recording data values | 80 |
| 14 | Analogue total (optional) | 81 |
| 14.1 | Activating the "analogue total" option | 81 |
| 14.2 | Selection of the sensor type | 82 |
| 15 | Cleaning/decontamination | 83 |
| 16 | Dismantling and disposal | 83 |
| 17 | SD card and battery | 84 |
| 18 | Declaration of conformity | 85 |
| 19 | Index | 86 |

1 Pictograms and symbols



General danger symbol (danger, warning, caution)



General note



Observe the installation and operating instructions (on the type plate)



Observe the installation and operating instructions

2 Signal words in accordance with ISO 3864 and ANSI Z 535

| | |
|------------|---|
| Danger! | Imminent hazard Consequences of non-observance: serious injury or death |
| Warning! | Potential hazard Consequences of non-observance: possible serious injury or death |
| Caution! | Imminent hazard Consequences of non-observance: possible injury or property damage |
| Notice! | Potential hazard Consequences of non-observance: possible injury or property damage |
| Important! | Additional advice, info, hints Consequences of non-observance: disadvantages during operation and maintenance, no danger |

3 Safety instructions



Please check whether or not these instructions correspond to the device type.

Please adhere to all advice given in these operating instructions. They include basic information which needs to be observed during installation, operation and maintenance. Therefore, it is vital for the technician and the responsible operator/qualified personnel to read these operating instructions prior to installation, start-up and maintenance.

The operating instructions must be accessible at all times at the place of application of the **METPOINT® BDL portable**. In addition to these operating instructions, local and national regulations need to be observed, where required.

If you have any queries regarding these instructions or the device, please contact the manufacturer.



Danger!

Supply voltage!

The contact with non-insulated parts carrying supply voltage involves the risk of an electric shock resulting in severe injuries and death.

Measures:

- Observe all regulations in effect during the electrical installation (e.g. VDE 0100)!
- **Maintenance works must only be carried out when the system is de-energized!**
- Any electrical works must only be carried out by authorised and skilled personnel.



Danger!

Inadmissible operating parameters!

Under-running or exceeding the limit values involves risks for persons and the material, and malfunction and service failures may occur.

Measures:

- Make sure that the **METPOINT® BDL portable** is operated only within the permissible limit values that are indicated on the type plate.
- Exact compliance with the performance data of the **METPOINT® BDL portable** in connection with the case of application.
- Do not exceed the permissible storage and transport temperature.

Further safety advice:

- During installation and operation, the national regulations and safety instructions in force also need to be observed.
- The **METPOINT® BDL portable** must not be employed in hazardous areas.

Additional instructions:

- Do not overheat the device!
- The **METPOINT® BDL portable** must not be disassembled!



Caution!

Malfunctions of the METPOINT® BDL portable

Through incorrect installation and insufficient maintenance, malfunctions of the **METPOINT® BDL portable** may occur. These can affect the indications and lead to misinterpretations.

4 Field of application

The new **METPOINT® BDL portable** is a universally employable hand-held measuring device for many applications in the industry like, for example:

- ▶ Consumption/flow measurement
- ▶ Pressure/vacuum measurement
- ▶ Temperature measurement
- ▶ Residual moisture/dew point measurement

With the 3.5" graphics display with a touch screen, operation is very easy.

The graphical presentation of the colored measuring curve is unique.

Up to 100 million measured values can be stored with a date and measuring point.

The measured values can be transmitted to the PC via USB stick.

At the freely configurable sensor input, the following sensors can optionally be connected:

- Pressure transducers (overpressure and negative pressure)
- Consumption sensors, FS 109/211
- Temperature sensors PT 100, 4 ... 20 mA
- Dew point sensors DP 109/110 and SD 21/23
- Electr. power meters
- Any external sensors with the following signals: 0 ... 1/10/30V,
 0/4 ... 20mA,
 Pt100, PT1000,

5 Proper use

The **METPOINT® BDL portable** hand-held measuring device serves for the mobile measured data acquisition and storage of analogue and digital input signals in non-hazardous areas.

The **METPOINT® BDL portable** hand-held measuring device is exclusively designed and constructed for the proper application purpose that is described herein and must only be used correspondingly.

A check in order to ascertain whether or not the device is suitable for the chosen employment must be carried out by the user. It must be ensured that the medium is compatible with the components which come into contact with it. **The technical data listed in the data sheet are binding.**

Improper handling or operation outside the technical specifications is impermissible. **Claims of any kind on the basis of improper use are excluded.**

Type plate/product identification

6 Type plate/product identification

The type plate is on the housing. It includes all the important data regarding the **METPOINT® BDL portable** hand-held measuring device which must be communicated to the manufacturer or supplier upon request.

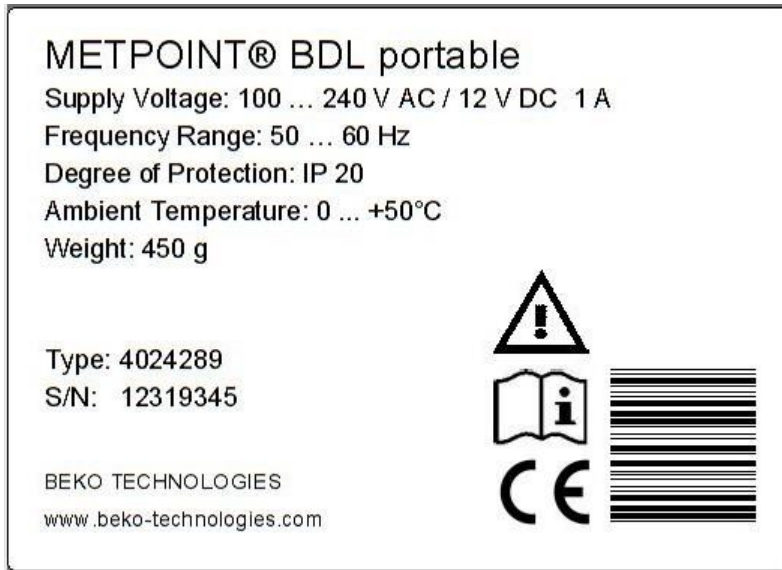

| METPOINT® BDL portable | Produktbezeichnung |
|------------------------|----------------------------------|
| Supply Voltage: | Versorgungsspannung |
| Frequency Range: | Frequenzbereich |
| Degree of Protection: | IP-Schutzart |
| Ambient Temperature: | Umgebungstemperatur |
| Weight: | Gewicht |
| Type: | Interne Artikelnummer (Beispiel) |
| S/N: | Seriennummer (Beispiel) |



Note:

Never remove, damage, or obliterate the type plate!

7 Storage and transport

Despite all due care and attention, transport damage cannot be excluded. Therefore, check the METPOINT® BDL portable for possible transport damage subsequent to transport and removal of the packaging material. The forwarding agent and BEKO TECHNOLOGIES or the BEKO TECHNOLOGIES agency shall be informed immediately about any kind of damage.



Warning!

Overheating!

Overheating will destroy the evaluation unit. Observe the permissible storage and transport temperature, as well as the permissible operating temperature (e.g. protect the measuring device against direct sunlight).



Warning!

Damage possible!

Damage may occur to the METPOINT® BDL portable through improper transport or storage.

Measures

- The METPOINT® BDL portable must only be transported or stored by authorised and trained skilled personnel.
- In addition, observe the respectively valid regional provisions and directives.



Caution!

Danger through damaged components!

Do not start-up a damaged METPOINT® BDL portable. Defective components can impair the operational reliability, falsify the measuring results, and cause further damage.

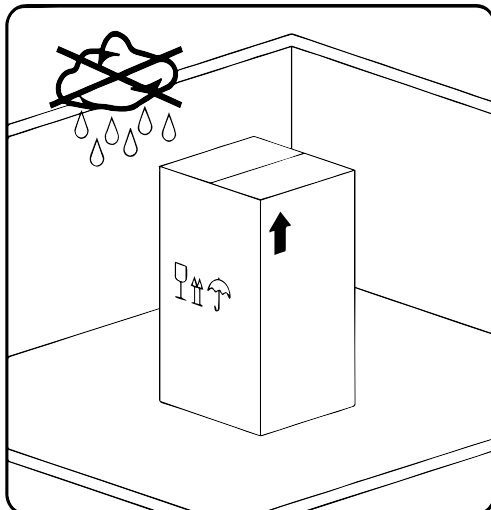

Store the METPOINT® BDL portable in its original packaging in a closed, dry, and frost-protected room. The ambient temperatures must not exceed/underrun the values indicated on the type plate.

Protect the device against atmospheric influences even when packaged.

Technical data METPOINT® BDL portable

8 Technical data METPOINT® BDL portable

| CE | |
|--------------------------|--|
| Color display | 3.5" touch panel, TFT transmissive, graphics, curves, statistics |
| Interfaces | USB interface |
| Power supply for sensors | Output voltage: 24 VDC \pm 10% Output current: 120 mA in continuous operation |
| Current supply | Internally chargeable Li-ion batteries, charging time approximately 4 h METPOINT® BDL portable continuous operation > 4 h depending on the power consumption for ext. sensor |
| Power supply unit | 100 – 240 VAC/50 – 60 Hz, 12VDC – 1A Safety class 2 only for the application in dry rooms |
| Dimensions | 82 x 96 x 245 mm |
| Housing material | PC/ABS |
| Weight | 450 g |
| Employment temperature | -20 ... +70 °C measuring-gas temperature 0 ... +50 °C ambient temperature |
| Storage temperature | -20 ... +70°C |
| Optional | Data logger, memory capacity 2 GB memory card standard, optional up to 4 GB |
| EMC | DIN EN 61326 |

9 Input signals ext. sensor METPOINT® BDL portable

| Input signals | | |
|---|------------------|--|
| Signal current (0 – 20 mA/4 – 20 mA) internal or external power supply | Measuring range | 0 – 20 mA/4 – 20 mA |
| | Resolution | 0.0001 mA |
| | Accuracy | $\pm 0.003 \text{ mA} \pm 0.05\%$ |
| | Input resistance | 50 Ω |
| Signal voltage (0 – 1 V) | Measuring range | 0 – 1 V |
| | Resolution | 0.05 mV |
| | Accuracy | $\pm 0.2 \text{ mV} \pm 0.05\%$ |
| | Input resistance | 100 k Ω |
| Signal voltage (0 – 10 V/30 V) | Measuring range | 0 – 10 V/30 V |
| | Resolution | 0.5 mV |
| | Accuracy | $\pm 2 \text{ mV} \pm 0.05\%$ |
| | Input resistance | 1 M Ω |
| RTD Pt100 | Measuring range | -200 – 850°C |
| | Resolution | 0.1 °C |
| | Accuracy | $\pm 0.2^\circ\text{C}$ at -100 ... 400 °C $\pm 0.3^\circ\text{C}$ (remaining range) |
| RTD Pt1000 | Measuring range | -200 – 850°C |
| | Resolution | 0.1°C |
| | Accuracy | $\pm 0.2 \text{ }^\circ\text{C}$ at -100 – 400°C $\pm 0.3 \text{ }^\circ\text{C}$ (remaining range) |
| Pulse | Measuring range | Min. pulse duration 100 μS Frequency 0 – 1 kHz Max. 30 VDC |

10 Installation



NOTE!

The plug of the power supply unit (charger) is used as a separator.

This separator must be clearly recognizable and easily accessible by the user. A plug connector with a CEE7/7 system is necessary.



NOTE!

Only use the included type GE12I12-P1J power supply unit.

10.1 Line cross-sections

For the sensor connections/output signals, the following line cross-section needs to be used:

AWG16 – AWG28, line cross-sections 0.14 – 1.5 mm²

11 Connection diagrams of the different sensor types

11.1 PIN assignment for the sensor connection

An ODU Medi Snap 8 pin is used as a sensor interface connector – reference: K11M07-P08LFD0-6550

These are the available connecting leads from BEKO TECHNOLOGIES GMBH:

ODU connector with open ends: order no. 4028338, cable length 5 m.

ODU connector with an SDI connecting plug: order no. 4028337, cable length 5 m.

Plug and cable configuration:

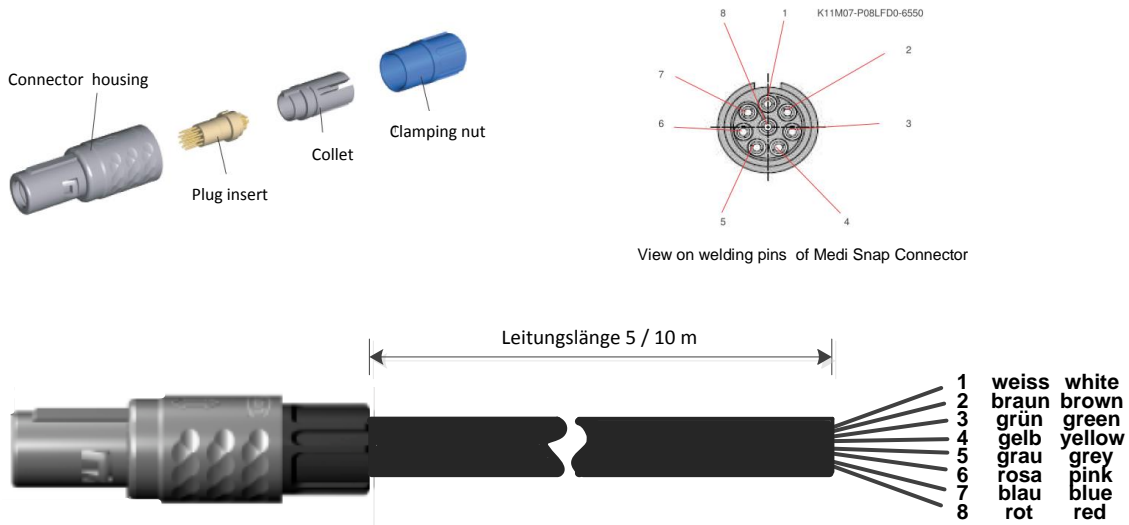

| | | | | | | | | | | | | | | | | | |
|--|----------------------------|-------|----------------------------|-------|-----------------|-------|-------------------------|--------|-----------------------|------|-----------------------------|------|-----------------------|------|---------------------|-----|---|
| <p>Abschlusswiderstand RS485 $\frac{1}{2}$ <input checked="" type="checkbox"/></p> <table border="1" style="width: 100%; border-collapse: collapse;"> <tr> <td style="text-align: center;">(+) A / RS485 \ominus 1</td> <td style="text-align: center;">White</td> </tr> <tr> <td style="text-align: center;">(-) B / RS485 \ominus 2</td> <td style="text-align: center;">Brown</td> </tr> <tr> <td style="text-align: center;">SDI \ominus 3</td> <td style="text-align: center;">Green</td> </tr> <tr> <td style="text-align: center;">Analog IN + \ominus 4</td> <td style="text-align: center;">Yellow</td> </tr> <tr> <td style="text-align: center;">Analog IN \ominus 5</td> <td style="text-align: center;">Grey</td> </tr> <tr> <td style="text-align: center;">I (500μA) \ominus 6</td> <td style="text-align: center;">Pink</td> </tr> <tr> <td style="text-align: center;">+Uv 24VDC \ominus 7</td> <td style="text-align: center;">Blue</td> </tr> <tr> <td style="text-align: center;">-Uv GND \ominus 8</td> <td style="text-align: center;">Red</td> </tr> </table> | (+) A / RS485 \ominus 1 | White | (-) B / RS485 \ominus 2 | Brown | SDI \ominus 3 | Green | Analog IN + \ominus 4 | Yellow | Analog IN \ominus 5 | Grey | I (500 μ A) \ominus 6 | Pink | +Uv 24VDC \ominus 7 | Blue | -Uv GND \ominus 8 | Red | <p>+ RS485</p> <p>- RS485</p> <p>SDI (BEKO-internal data transmission for all the dew point/consumption sensors)</p> <p>ANALOGUE IN + (current signal and voltage signal)</p> <p>ANALOGUE IN - (current signal and voltage signal)</p> <p>POWER SUPPLY 500 μA</p> <p>+Uv, 24V DC power supply for sensors</p> <p>-Uv, GND sensor</p> |
| (+) A / RS485 \ominus 1 | White | | | | | | | | | | | | | | | | |
| (-) B / RS485 \ominus 2 | Brown | | | | | | | | | | | | | | | | |
| SDI \ominus 3 | Green | | | | | | | | | | | | | | | | |
| Analog IN + \ominus 4 | Yellow | | | | | | | | | | | | | | | | |
| Analog IN \ominus 5 | Grey | | | | | | | | | | | | | | | | |
| I (500 μ A) \ominus 6 | Pink | | | | | | | | | | | | | | | | |
| +Uv 24VDC \ominus 7 | Blue | | | | | | | | | | | | | | | | |
| -Uv GND \ominus 8 | Red | | | | | | | | | | | | | | | | |

Connection diagrams of the different sensor types

DP series: dew point sensors

FS series: consumption sensors

SD series: pressure dew point transmitters

11.2 Connection dew point sensors DP series

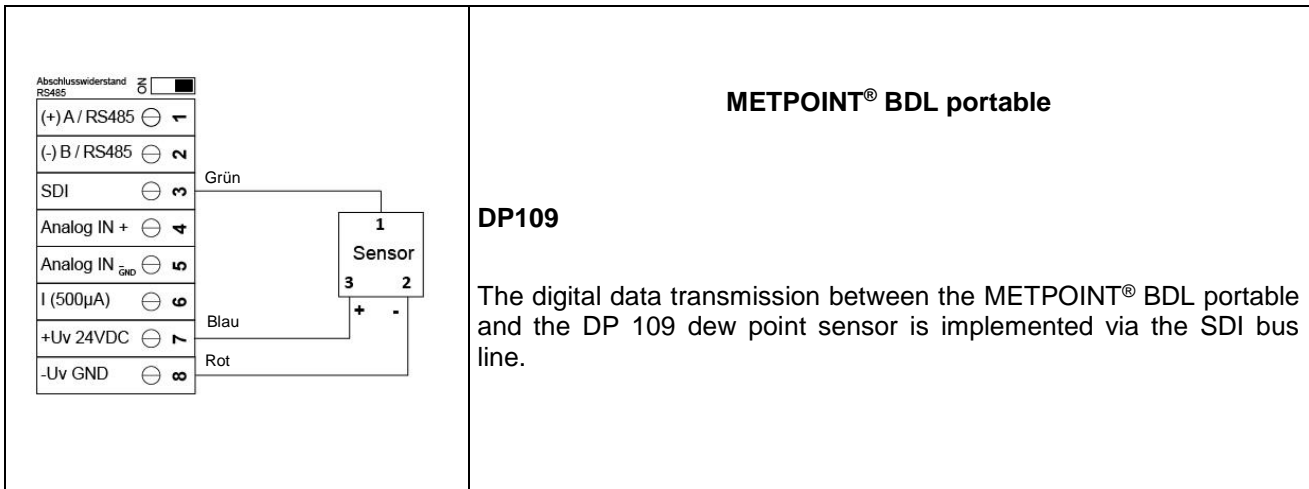

11.3 Connection dew point sensors DP/FS series

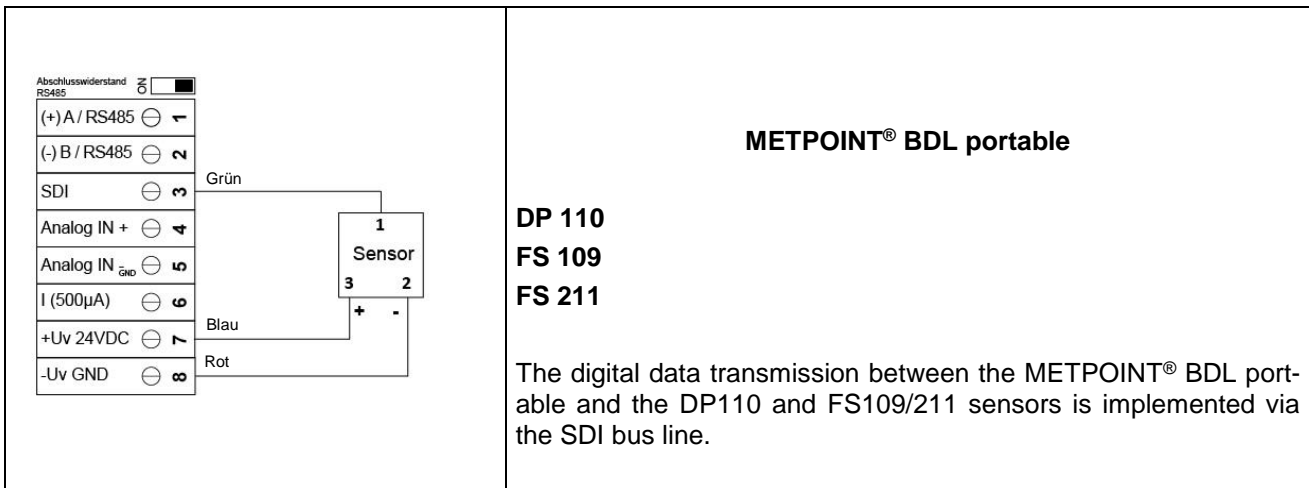

11.4 Connection dew point sensors SD series

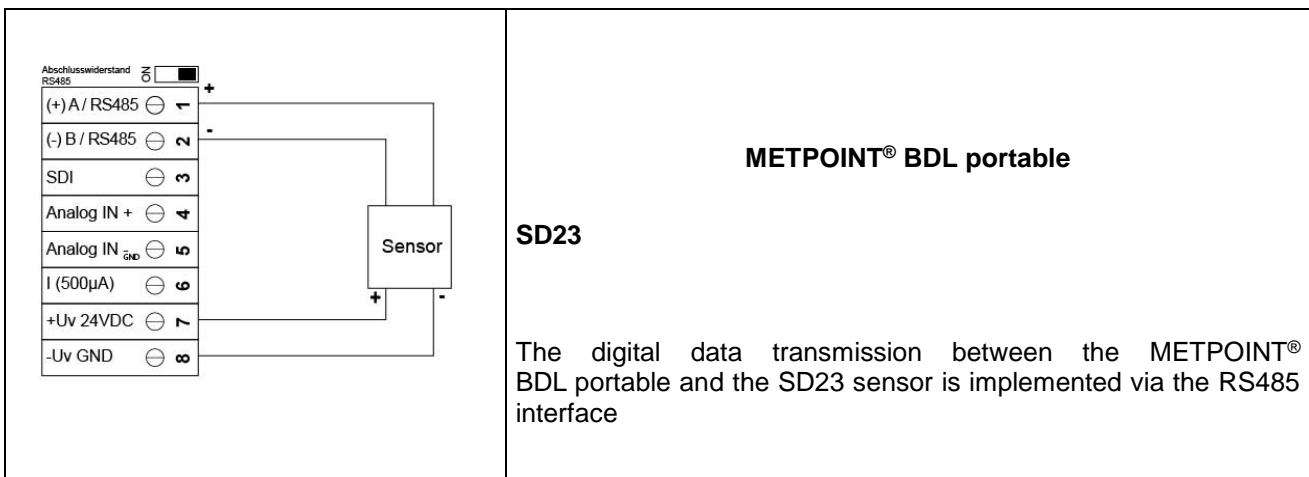

11.5 Connection pulse sensors

| | |
|--|--|
| | <p>Signal level 0: low = 0 – 0.7 VDC</p> <p>Signal level 1: high = 2.5 – 30 VDC</p> <p>$t = 400 \mu s$</p> <p>max. frequency (pulse duty factor 1:1) = 1000 Hz</p> <p>Input resistance: min. 100 kOhm</p> |
| | <p>Externally required $R = 4K7$</p> <p>Caution: Counts one unit of consumption when switching on the DP510</p> |
| | <p>Externally required $R = 4K7$</p> |
| | <p>This is impossible!</p> |

Connection diagrams of the different sensor types

11.6 Analogue 2-wire, 3-wire, and 4-wire current signal

| Sensors with 4 - 20 mA output in 2-wire technology | |
|--|--------------------------------------|
| | <p>METPOINT® BDL portable</p> |
| Sensors with a 0/4 – 20 mA output in 3-wire technology | |
| | <p>METPOINT® BDL portable</p> |
| Sensors with a 0/4 – 20 mA output in 4-wire technology | |
| | <p>METPOINT® BDL portable</p> |

11.7 3 and 4-wire voltage supply 0 - 1/10/30 VDC

| | |
|--|--|
| | <p>Sensors with a voltage output in 3-wire technology</p> |
| | <p>Sensors with a voltage output in 4-wire technology</p> |

Connection diagrams of the different sensor types

11.8 2, 3, and 4-wire terminal assignment of PT100/PT1000/KTY81

| | |
|--|---|
| <p>Abschlusswiderstand RS485 $\frac{Z}{\Omega}$ <input type="checkbox"/></p> <p>(+) A / RS485 1</p> <p>(-) B / RS485 2</p> <p>SDI 3</p> <p>Analog IN + 4</p> <p>Analog IN _{gnd} 5</p> <p>I (500μA) 6</p> <p>+Uv 24VDC 7</p> <p>-Uv GND 8</p> <p>Gelb</p> <p>Pink</p> <p>Rot</p> <p>Sensor</p> | <p>2-wire PT100/PT1000/KTY81</p> |
| <p>Abschlusswiderstand RS485 $\frac{Z}{\Omega}$ <input type="checkbox"/></p> <p>(+) A / RS485 1</p> <p>(-) B / RS485 2</p> <p>SDI 3</p> <p>Analog IN + 4</p> <p>Analog IN _{gnd} 5</p> <p>I (500μA) 6</p> <p>+Uv 24VDC 7</p> <p>-Uv GND 8</p> <p>Gelb</p> <p>Grau</p> <p>Pink</p> <p>Rot</p> <p>Sensor</p> | <p>3-wire PT100/PT1000/KTY81</p> |
| <p>Abschlusswiderstand RS485 $\frac{Z}{\Omega}$ <input type="checkbox"/></p> <p>(+) A / RS485 1</p> <p>(-) B / RS485 2</p> <p>SDI 3</p> <p>Analog IN + 4</p> <p>Analog IN _{gnd} 5</p> <p>I (500μA) 6</p> <p>+Uv 24VDC 7</p> <p>-Uv GND 8</p> <p>Gelb</p> <p>Grau</p> <p>Pink</p> <p>Rot</p> <p>Sensor</p> | <p>4-wire PT100/ 1000/KTY81</p> |

11.9 Assignment with RS485

| | |
|--|--|
| <p>Abschlusswiderstand RS485 $\frac{Z}{\Omega}$ <input type="checkbox"/></p> <p>(+) A / RS485 1</p> <p>(-) B / RS485 2</p> <p>SDI 3</p> <p>Analog IN + 4</p> <p>Analog IN _{gnd} 5</p> <p>I (500μA) 6</p> <p>+Uv 24VDC 7</p> <p>-Uv GND 8</p> <p>+ Weiss</p> <p>- Braun</p> <p>Blau</p> <p>Rot</p> <p>Sensor</p> | <p>Sensor with an RS485 interface</p> |
|--|--|

12 Operation METPOINT® BDL portable

The operation of the METPOINT® BDL portable is implemented by means of a membrane keyboard and touch panel.

12.1 Membrane keyboard

12.1.1 On and off key

Switching on or off by pressing the  button and holding it.

12.1.2 Brightness keys

With the  and  buttons, the brightness of the display can be modified.

12.1.3 Screenshot button

 By pressing the screenshot button, the current screen display is stored. An SD card or USB stick serve as a storage medium.

12.1.3.1 Storing a screenshot

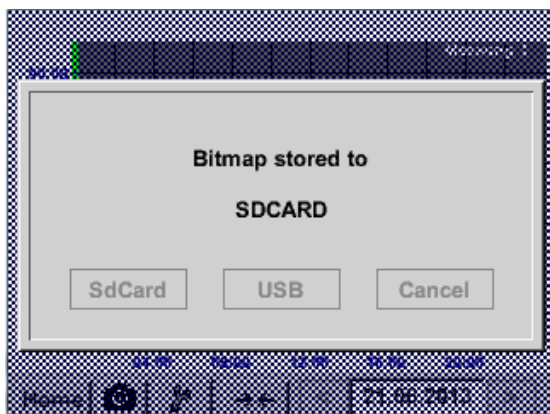
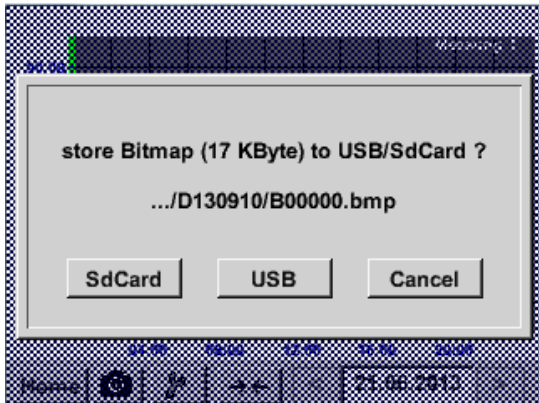

Here, the storage location USB stick or SD card can be selected.

The pictures are stored in a directory per day and are consecutively numbered.

Directory designation; DJJMMTT

D=fix(for the date)

JJ = Year

MM= Month

TT= Day

Path: DEV0003/PI500/Bitmap

Example: first picture 10 September 2013

\\DEV0003/BDL/Bitmap/D130910/B00000.bmp

12.1.3.2 Exporting screenshots

The screenshots that are stored on the SD card can be exported to a USB stick.

Main menu → Export data



With *Export screenshots*, the stored screenshots can be transmitted to a USB stick.

Main menu → Export data → Export screenshots



By means of the *Selection* buttons, a period of time between *start* and *end* can be set. The stored bitmaps, which are within this period, are exported.

Main menu → Export data → Export screenshots → Selection



The selected date is always highlighted in green, and the date figures of the Sundays are red, as is the case in a calendar.

On days on which bitmaps were recorded, the date figures are optically raised.

Main menu → Export data → Export screenshots → Exporting

*** Export Screenshots ***

Start 10.09.2013 Auswahl

Ende 10.09.2013 Auswahl

Ausgewählte Dateien: 5
Tot. Size(Kbyte): 83

Zurück Exportieren

The screenshots of the selected period of time are exported to a USB stick.

12.2 Touch panel

The operation is menu-driven to the largest possible extent via the touch panel.

The selection of the respective menu items is realized via short "tapping" with the finger or using a soft-pointed pen.

**Caution: Please do not use pens or other objects with sharp edges!
The foil may be damaged!**

In the event that a sensor was connected, the latter also needs to be configured.

Entries or changes can be made in all the fields with a white background.

The measured values can be displayed as a curve or as values.

Words in *green letters* mainly point to the illustration(s) in the chapter section. But also related important menu paths or menu items are marked in *green letters*.

The menu navigation is generally shown in *green letters*!

The table of contents and the chapter references in *blue letters* contain links to the respective chapter headers.

12.3 Main menu (home)

You can go to every available sub item via the main menu.

12.3.1 Initialization



Subsequent to the switching-on of the METPOINT® BDL portable, the channel is initialized and the "*Current values*" menu appears.

Caution:

At the first start-up of a METPOINT® BDL portable, an ext. channel may not be preset.

Please select the suitable configurations in Chapter [7.3.2.1.2 Sensor Einstellung](#) and set them!

12.3.2 Main menu

Home

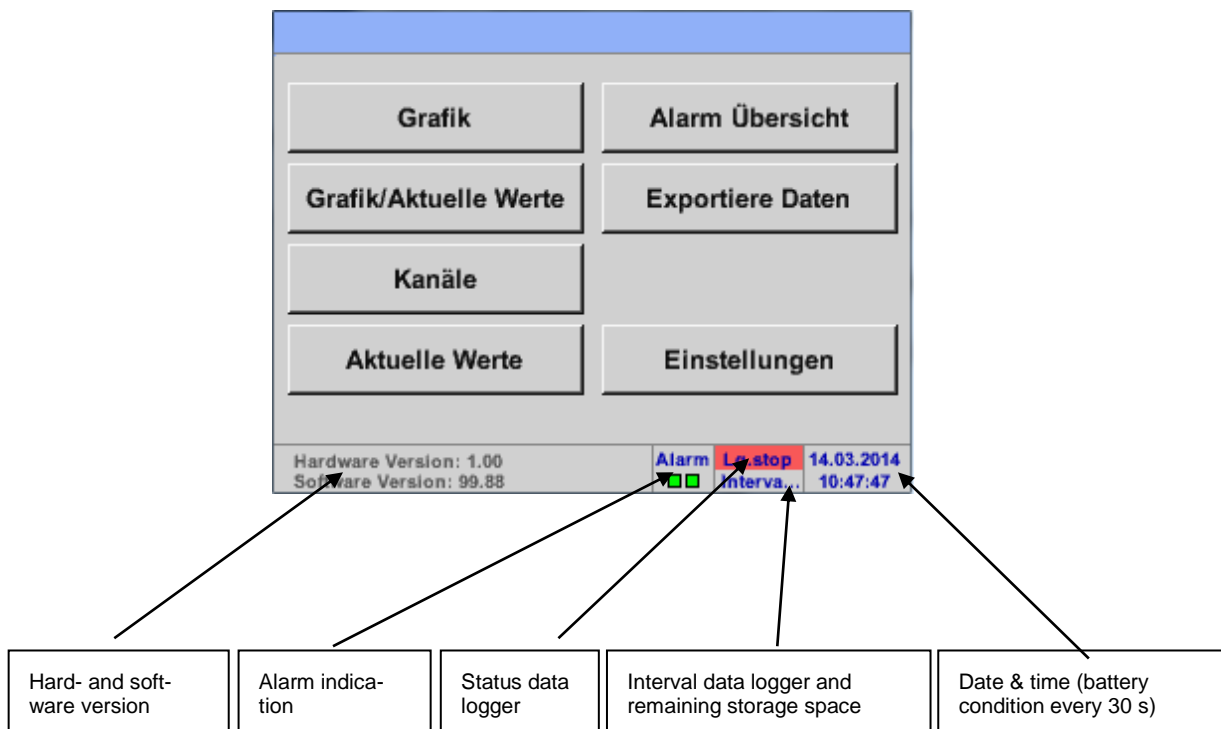

Important:

Prior to carrying out the first sensor settings, the language and time should be set.

Note:

Chapter [7.3.2.1.4.1 Sprache](#)

(English menu navigation: *Main* → *Settings* → *Device Settings* → *Set Language*)

Chapter [7.3.2.1.4.2 Datum & Uhrzeit](#)

(English menu navigation: *Main* → *Settings* → *Device Settings* → *Date & Time*)

12.3.2.1 Settings

All the settings are password-protected!

Settings or changes must generally be confirmed by **OK**!

Note:

When returning to the main menu and calling again one of the setting menus afterwards, the password must be re-entered!

Main menu → Settings

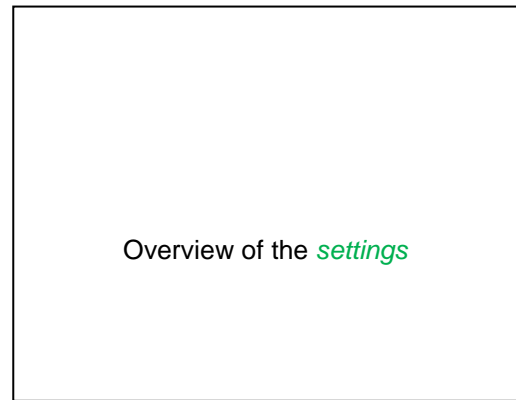

12.3.2.1.1 Password setting

Main menu → Settings → Password setting



Password when delivered: 0000 (4 x zero).

If required, it can be changed under:
Password settings.

The new password must be entered twice and confirmed by **OK**.



In the event that a wrong password is entered, *Enter password* or *Repeat new password* will appear in red letters.

In the event of a forgotten password, a new password can be created by entering the master password.

The master password is supplied along with the device documentation.

12.3.2.1.2 Sensor settings

Important:

Sensors from BEKO TECHNOLOGIES GMBH are generally pre-configured and can be directly connected to the sensor channel!

Main menu → Settings → Sensor settings



After having entered the password, the overview window of the channel will appear.

Note:

Normally, the ext. channel is not preset!

12.3.2.1.2.1 Selection of the ext. sensor type (example: BEKO digital sensor type)

Main menu → Settings → Sensor settings → C1

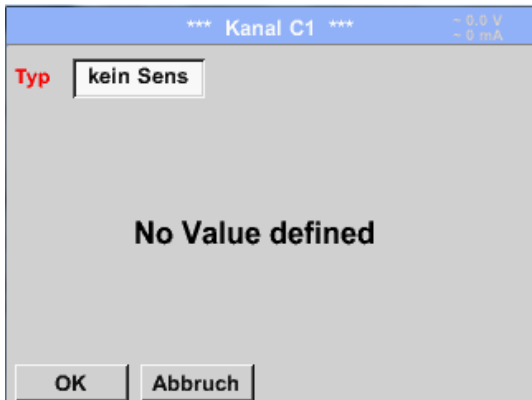

If no sensor was configured yet, the, *Type no sensor* will appear.

By pressing on the text field *Type no sensor*, you will go to the selection list of the sensor types (see next step).

Main menu → Settings → Sensor settings → C1 → Text field type → BEKO digital

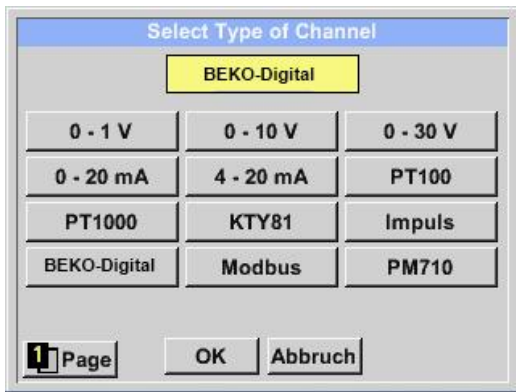

Now, the *Type BEKO digital* is selected for the VA/FA 400 series and confirmed by *OK*.

Main menu → Settings → Sensor settings → C1 → Right arrow (2nd page) → Text field diameter

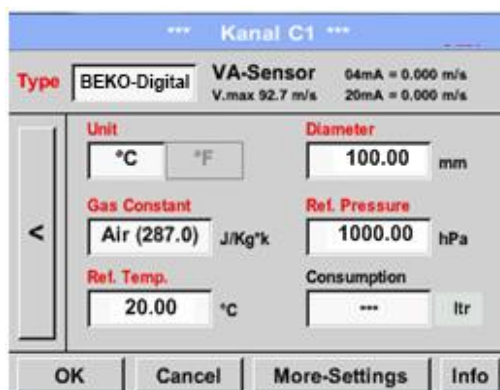

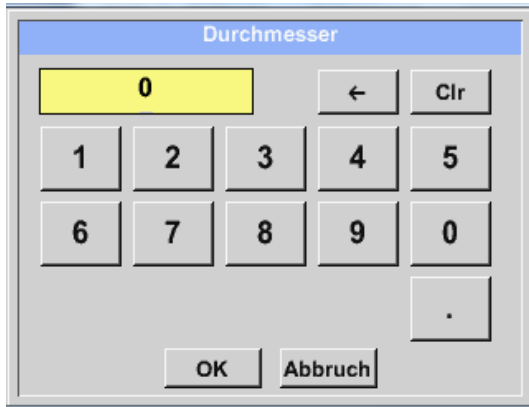

Here, the *inner diameter* of the flow pipe can be entered in the event that it was not automatically correctly set.

In addition, the *counter reading* of the previous sensor can be entered when replacing the sensor.

Please confirm with *OK* and go back with the *left arrow (1st page)*.

Important:

The *inner diameter* should be entered as exactly as possible, since, otherwise, the measuring results will be falsified!

No uniform standard exists for the inner diameter of the pipe!

(Please ask the manufacturer or, if possible, check the measurements yourself!)

Main menu → Settings → Sensor settings → C1



Now, a *name* can be entered.

Main menu → Settings → Sensor settings → C1



Subsequent to marking and confirming by *OK*, the configuration of the sensor is completed.

Further **configuration possibilities regarding sensors**, see Chapters 12.2.2.5 to 12.2.2.8!

[See also Chapter 7.3.2.1.2.7 Textfelder beschriften und einstellen](#)

Note:

After having confirmed by *OK*, the lettering is switched to black again. The values and settings have been accepted.

Caution:

Reference temperature and reference pressure (setting ex works 20°C, 1000 hPa):

All the volume flow (m³/h) and consumption values (m³) that are indicated on the display refer to 20°C and 1000 hPa (according to ISO 1217 suction condition).

Alternatively, 0°C and 1013 hPa (=standard cubic meter according to DIN 1343) can also be entered as the reference. Under no circumstances must the operating pressure or the operating temperature be entered into the reference conditions!

Operation METPOINT® BDL portable

12.3.2.2 Denoting the measuring data and determining the resolution of the decimal places

Note:

The *resolution* of the decimal places, *short name* and *value name* can be found below the **tool button**!



Tool button:

Main menu → Settings → Sensor settings → C1 → Tool button



For the *value* to be recorded, a *name* with 10 characters can be entered in order to simplify its identification at a later moment in the menu items *Graphics* and *Graphics/current values*.

Otherwise, the designation would be C1a, for example.

C1 is the channel name and a is the first measured value in the channel, while b would be the second, and c the third.

The *resolution* of the decimal places is easi-

[See Chapter 7.3.2.1.2.7 Textfelder beschriften und einstellen](#)

12.3.2.2.1.1 Recording measuring data

Main menu → Settings → Sensor settings → C1 → Recording button



With the *recording* buttons, the measuring data are selected which will be stored at an **activated data logger**.

Caution:

Prior to recording the selected measuring data, the data logger must be activated subsequent to the completion of the settings (see Chapter [7.3.2.1.3.2 Logger-Einstellung \(Datenlogger\)](#)).

12.3.2.2.1.2 Alarm settings (alarm pop-up)

Main menu → Settings → Sensor settings → C1 → Alarm button

By pressing an alarm button, the following window will appear:

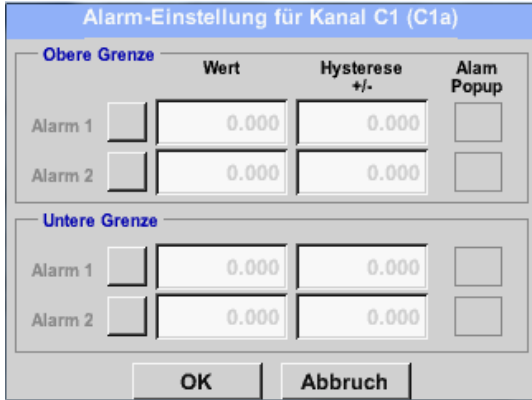

In the alarm settings, an *alarm-1* and *alarm-2* incl. *hysteresis* can be entered for each channel.

Via the *alarm overview* menu item (via the main menu), the alarm settings can also be configured or changed.

Main menu → Settings → Sensor settings → C1 → Alarm button → Alarm 1 and Alarm 2 buttons + Alarm pop-up buttons

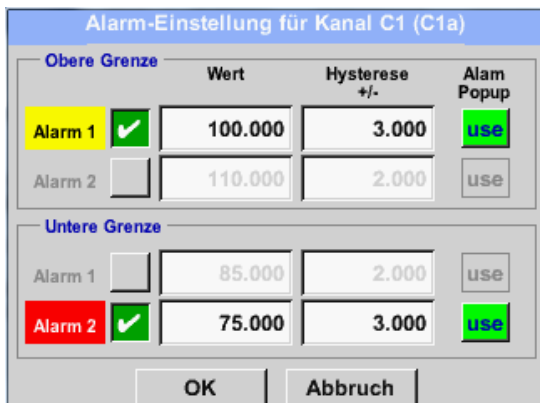

Here, for example, the *Alarm-1* yellow and the *Alarm-2* red.

Main menu → Settings → Sensor settings → C1



Subsequent to the alarm activation at channel C1.

The settings are completed by means of the **OK** buttons!

12.3.2.2.1.3 Advanced settings (scaling analogue output)

Main menu → Settings → Sensor settings → C1 → Right arrow (2nd page) → Advanced settings

Erweiterte Einst. A1-Luft-1

4...20mA Sensorausgang

Basis

m³/h m/s

Skalierung manuell

4mA = 0.000 m/s

20mA = -1.#10 m/s

Max. Geschw. 92.700 m/s

OK Abbruch

Kalibrierdaten

Gas Air (287.0)

Temperat 293.0 °K

Druck 1000.0 hPa

Fläche 110.0 mm²

Kalibriert 24.07.2013

Erweiterte Einst. A1-Luft-1

4...20mA Sensorausgang

Basis

°C m/s

Skalierung manuell

4mA = 0.000 m/s

20mA = 200.000 m/s

Max. Geschw. 92.700 m/s

OK Abbruch

Kalibrierdaten

Gas Air (287.0)

Temperat 293.0 °K

Druck 1000.0 hPa

Fläche 110.0 mm²

Kalibriert 24.07.2013

In the *advanced settings*, it can be determined whether the 4-20 mA analogue output of the sensor should be based on the flow volume or on the velocity.

The text field with a green background was chosen!

In addition, the measuring range can be set by pressing the *scaling manual* button.

After the confirmation with *OK*, the settings are accepted.

Note:

The *advanced setting* is only available for **BEKO digital**.

The settings are completed by means of the *OK* buttons!

Note:

After having confirmed by *OK*, the lettering is switched to black again. The values and settings have been accepted.

12.3.2.3 Dew point sensor with the BEKO digital type

First step: select a free sensor channel

Main menu → Settings → Sensor settings → C1

Second step: Select type BEKO Digital

Main menu → Settings → Sensor settings → C1 → Type text field → BEKO digital

Third step: confirm twice with OK

Now, a **name** (see Chapter 7.3.2.1.2.7 [Textfelder beschriften und einstellen](#)), the **alarm settings** (see Chapter 7.3.2.1.2.4 [Alarm-Einstellung](#)), and **recording settings** (see Chapter 7.3.2.1.2.3 [Messdaten aufzeichnen](#)), as well as the **resolution** of the decimal places (see Chapter 7.3.2.1.2.2 [Die Messdaten bezeichnen und Auflösung der Nachkommastellen bestimmen](#)) can be determined.

Main menu → Settings → Sensor settings → C1



The METPOINT® BDL portable recognizes whether the connected sensor is a flow rate or a dew point sensor from BEKO TECHNOLOGIES GMBH and automatically sets the **BEKO** subtype correctly.

12.3.2.3.1.1 Marking and setting text fields

Main menu → Settings → Sensor settings → C1



If the data logger is activated, the following window appears. By pressing **yes**, the data logger can be deactivated.
(Only activated when settings and recordings were already implemented)

Note:
 When sensor settings are implemented or changed, the data logger must be on **STOP**.

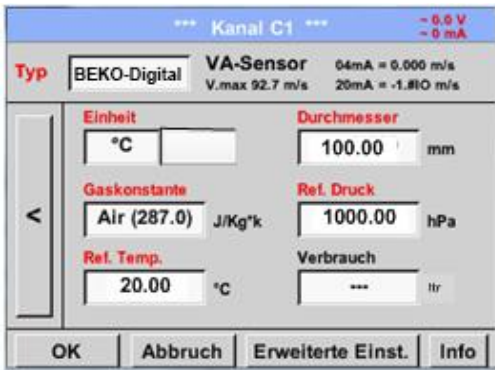

By pressing on fields with a white background, changes or entries can be made.

The **alarm** (see Chapter 12.2.2.4 Alarm settings) and **recording** buttons (see Chapter 12.2.2.3 Recording measuring data), the **resolution** of the decimal places and the **short name** or the **value name** (see Chapter 12.2.2.2 Denoting the measuring data and determining the resolution of the decimal places), as well as the **advanced settings** (see Chapter 12.2.2.5 Advanced settings) are all described in Chapter 12.2.2 Sensor settings.

Main menu → Settings → Sensor settings → C1 → Text field name



It is possible to enter a name with up to 24 characters.

Main menu → Settings → Sensor settings → C1 → Text field type

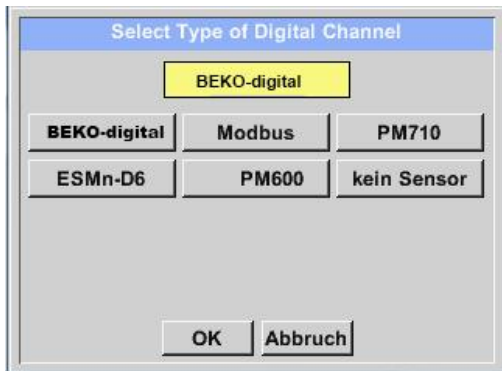

After having pressed the *Type* text field, the following options can be chosen.

See also Chapter [7.3.2.1.2.8 Konfiguration von Analogsensoren](#)

Main menu → Settings → Sensor settings → C1 → Text field unit

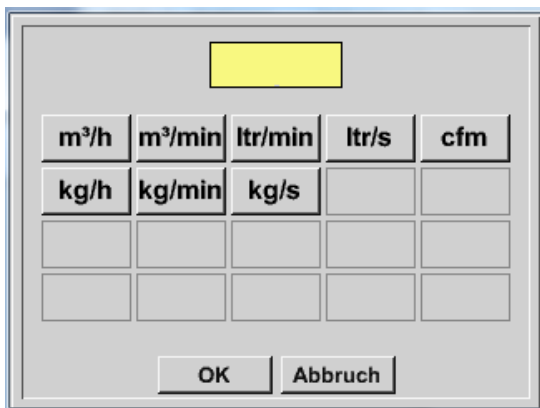

A preset selection of suitable *units*.

Main menu → Settings → Sensor settings → C1 → Right arrow (2nd page) → Text field diameter

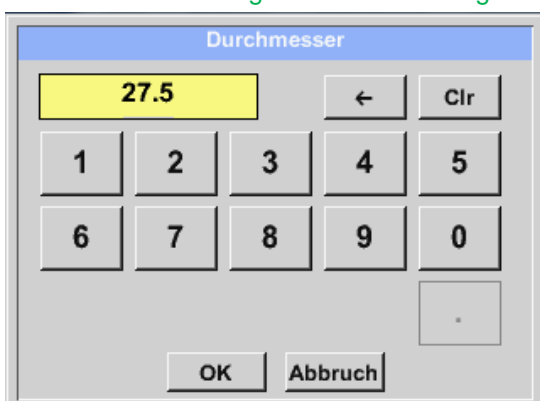

Important:

Here, the *inner diameter* of the flow pipe can be entered in the event that it was not automatically correctly set.

Here, 27.5 mm, for example, are entered for the *inner diameter*.

Important:

The *inner diameter* should be entered as exactly as possible, since, otherwise, the measuring results will be falsified!

No uniform standard exists for the inner diameter of the pipe!

(Please ask the manufacturer or, if possible, check the measurements yourself!)

Operation METPOINT® BDL portable

Main menu → Settings → Sensor settings → C1 → Right arrow (2nd page) → Text field gas constant

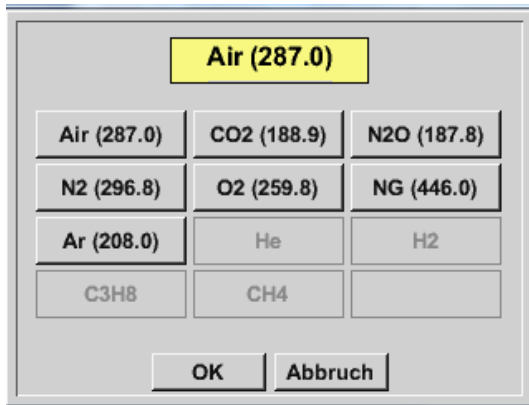

A preset selection of suitable *gas constants*.

The remaining text fields can be marked in the same manner as is described here, in Chapter [7.3.2.1.2.7 Textfelder beschriften und einstellen](#)

!

Main menu → Settings → Sensor settings → C1 → Right arrow (2nd page)

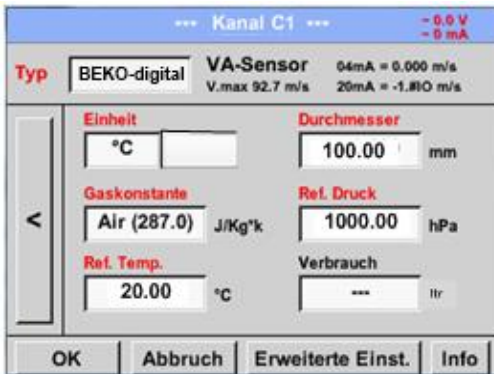

The text fields with red letters show that different values, such as the *diameter* and the *name*, were changed or added.

See also Chapter [7.3.2.1.2.2.1 Auswahl des Sensortyps \(Beispiel Typ BEKO-Digital Sensor\)](#)

Note:

After having confirmed with **OK**, the lettering returns to black and the values and settings are accepted.

Caution:

Reference temperature and reference pressure (setting ex works 20°C, 1000 hPa):

All the volume flow (m³/h) and consumption values (m³) that are indicated on the display refer to 20°C and 1000 hPa (according to ISO 1217 suction condition).

Alternatively, 0°C and 1013 hPa (=standard cubic meter according to DIN 1343) can also be entered as the reference. Under no circumstances must the operating pressure or the operating temperature be entered into the reference conditions!

12.3.2.3.1.2 Configuration of analogue sensors

Short overview of the possible *Type* settings including examples. For *BEKO-Digital*, see Chapters [7.3.2.1.2.1 Auswahl des Sensortyps \(Beispiel Typ BEKO-Digital Sensor\)](#) and [7.3.2.1.2.6 Taupunktsensor mit dem Typ BEKO-Digital](#).

The *alarm settings*, *recording* buttons, the *resolution* of the decimal places as well as the *short name* and *value name* are all described in Chapter [7.3.2.1.2 Sensor-Einstellung](#).

For the marking of the text fields, see Chapter [7.3.2.1.2.7 Textfelder beschriften und einstellen!](#)

12.3.2.3.1.3 Types 0 - 1/10/30 Volt and 0/4 – 20 mA

Main menu → Settings → Sensor settings → C1 → Type text field → 0 - 1/10/30 V

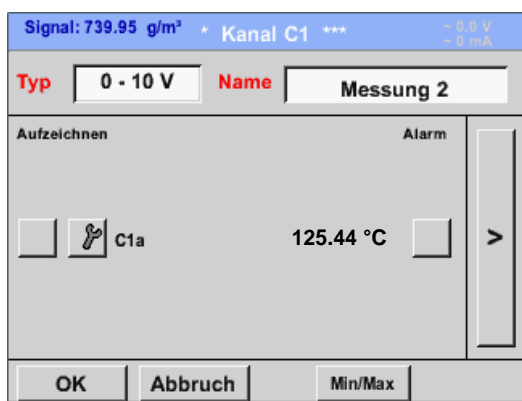

Scaling of the sensor (here, for example, *type 0 – 10 V* - corresponds to 0 – 250°C) can be found in the data sheet of the connected sensor.

Main menu → Settings → Sensor settings → C1 → Right arrow (2nd page)

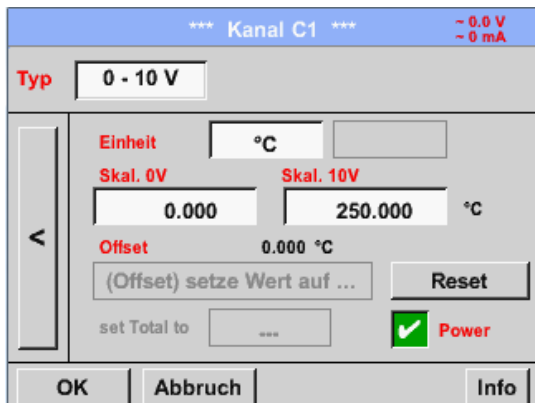

For *scal. 0 V*, please enter the lower scale value and for *scal. 10 V* the upper scale value.

The *ext. sensor supply voltage* is switched on when the sensor type requires this.

Please confirm with *OK*.

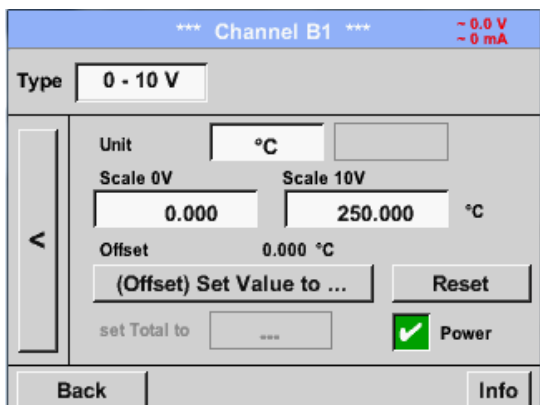

With the *Set-value-to* button (*offset*), the measured data of the sensor can be set to a certain value.

The positive or negative difference of the *offset* is indicated.

With the *reset* button, the *offset* can be reset to zero.

Operation METPOINT® BDL portable

Main menu → Settings → Sensor settings → C1 → Unit text field

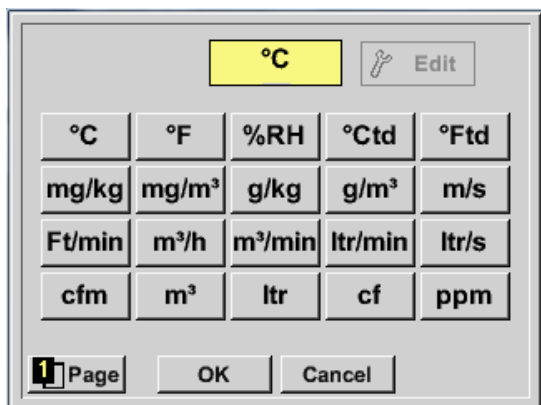

A preset selection of suitable units for *types* 0 - 1/10/30 V and 0/4 - 20 mA.

By pressing the *page* button, paging forward is possible.

In addition, internal "user" units can be defined, if required.

Here, the user unit is defined by selecting the *Edit* button, analogously to the edition of a *text field*.

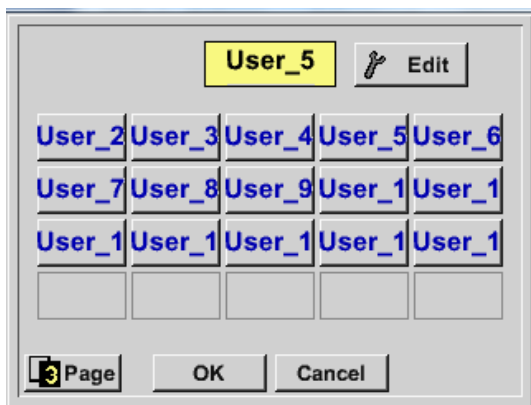

Main menu → Settings → Sensor settings → C1 → Type text field → 0/4-20mA



Here, for example *Type 4 - 20 mA*.

12.3.2.3.1.4 Types PT100x and KTY81

Main menu → Settings → Sensor settings → C1 → Type text field → PT100x

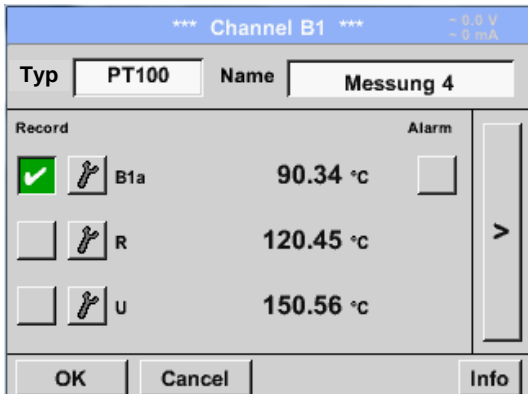

Here, the sensor type *PT100* and the *unit* °C were chosen. Alternatively, the sensor types *PT1000* and *KTY81*, as well as the *unit* °F can be selected.

Please refer to Chapter [7.3.2.1.2.9 Typ 0 - 1/10/30 Volt und 0/4 - 20 mA](#) for further setting possibilities!

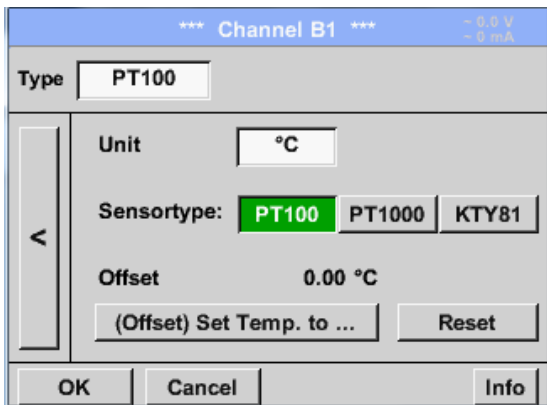

12.3.2.3.1.5 Type pulse (pulse value)

Main menu → Settings → Sensor settings → C1 → Type text field → Pulse

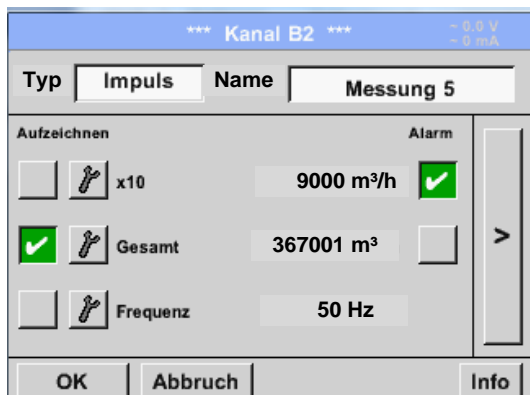

Normally, the numerical value with the unit stands for **1 pulse** on the sensor and can directly be entered into the **1 pulse =** text field.

Note:
Here, all of the text fields are already lettered or assigned.

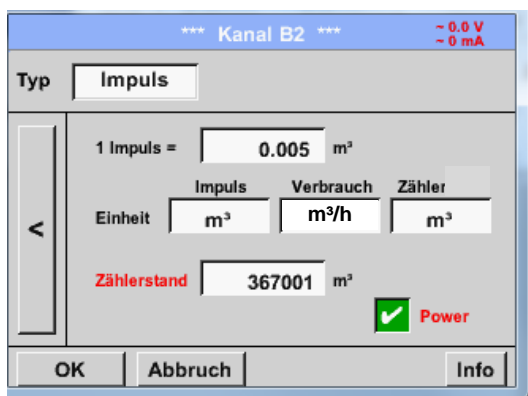

Main menu → Settings → Sensor settings → C1 → Right arrow (2nd page) → Unit pulse

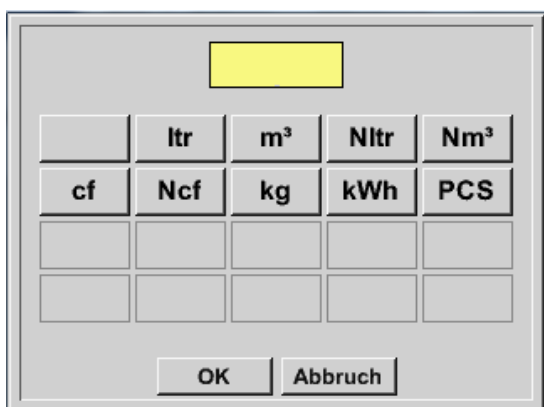

For the **unit pulse**, a flow volume or energy consumption can be chosen as a unit.

Main menu → Settings → Sensor settings → C1 → Right arrow (2nd page) → Consumption

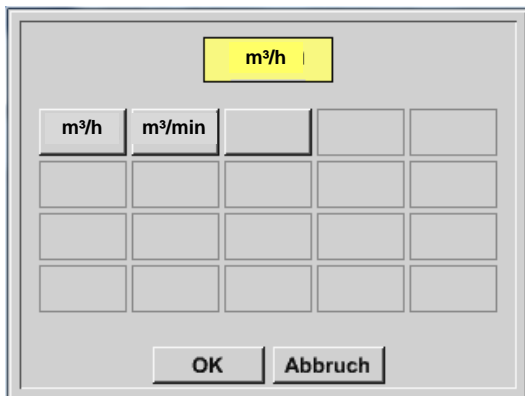

Units for the *current consumption* for the **pulse type**.

Note:

Example with the unit cubic meter!

Main menu → Settings → Sensor settings → C1 → Right arrow (2nd page) → Unit meter

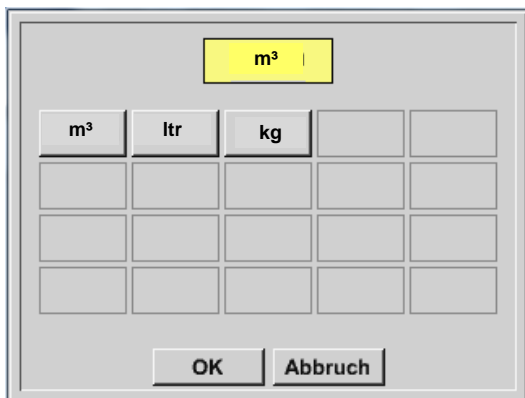

The available units for the *unit of the counter* for the **pulse type**

The **counter reading** can, at all times, be set to any or a desired value.

Please refer to Chapter [7.3.2.1.2.9 Typ 0 - 1/10/30 Volt und 0/4 - 20 mA](#) for further setting possibilities!

12.3.2.3.1.6 Type no sensor

Main menu → Settings → Sensor settings → C1 → Type text field → No sensor

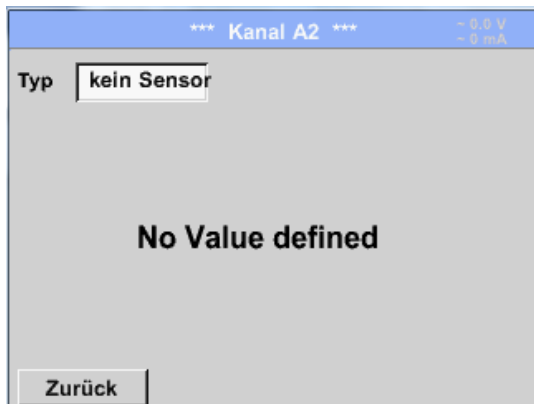

Serves to declare a channel which is currently not required as *not configured*.



When *returning* from *Type no sensor* to sensor settings, the channel is displayed as *free*.

12.3.2.3.1.7 Type Modbus

12.3.2.3.2 Selection and activation of the sensor type

First step: select a free sensor channel

Main menu → Settings → Sensor settings → C1

Second step: select the Modbus type

Main menu → Settings → Sensor settings → C1 → Type text field → Modbus

Third step: confirm with OK

Now, a *name* (see Chapter 7.3.2.1.2.7 [Textfelder beschriften und einstellen](#)) can be entered.

Main menu → Settings → Sensor settings → C1 → Right arrow (2nd page) → VA → Use

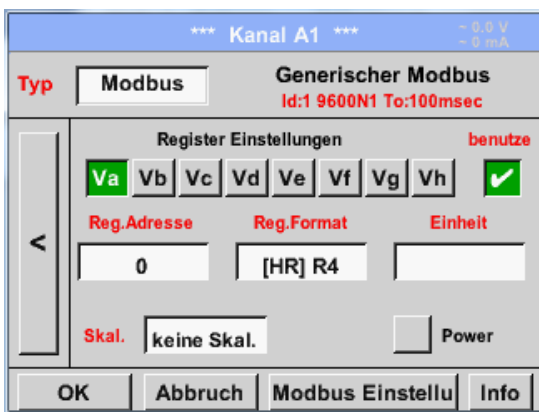

Via Modbus, up to eight registry values (from input or holding registers) of the sensor can be read out.

Selection via the register tabs *Va – Vh* and activation by means of the respective *use* button.

12.3.2.3.2.1.1 General Modbus settings

Main menu → Settings → Sensor settings → C1 → Right arrow (2nd page) → Modbus settings → ID text field

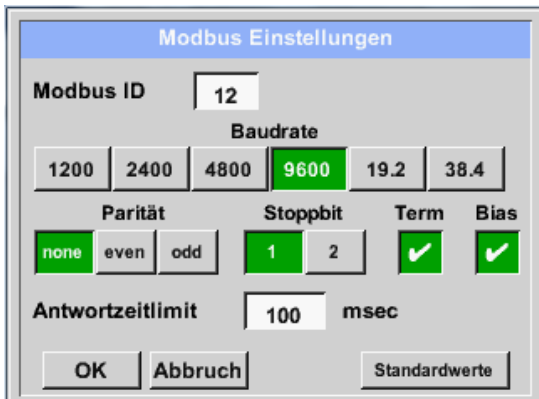

Here the *Modbus ID* is entered which is determined for the sensor, permissible values are 1 – 247, (ex. here *Modbus ID* = 12)

In addition, the serial transmission settings *baud rate, stop bit, parity bit, and timeout time* need to be defined.

When the PI 510 is connected to the end of the bus, the termination can be activated via the *Term* button.

Grundsätzlich sollte ein **BIAS** vom BUS-Master erfolgen kann bei Bedarf kann aber über **Bias** Knopf ein BIAS zugeschaltet werden Sorry, Satz nicht identifizierbar – bitte Rücksprache!

Confirmation with **OK**.

Resetting to the initial settings by means of the *Set to default* button.

Please refer to the data sheet of the sensor for the setting of the Modbus ID and the transmission settings. **Bitte deutsches Feld löschen???**

Operation METPOINT® BDL portable

Main menu → Settings → Sensor settings → C1 → Reg. address text field

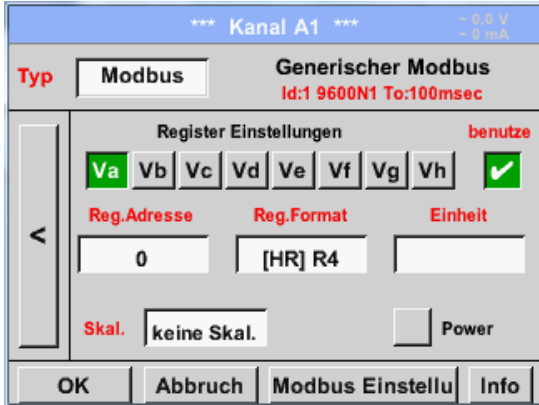

The sensor provides the measured values in registers. The values can be located and read out by the METPOINT® BDL PORTABLE via Modbus.

For this purpose, the desired register addresses need to be set in the METPOINT® BDL PORTABLE.

The entry of the *register/data address* is implemented in decimal values from 0 to 65535.

Important:

Here, the correct *register address* is required.

It must be observed that the register number may differ from the register address (offset). Please refer to the sensor/transducer data sheet for this purpose.

Main menu → Settings → Sensor settings → C1 → Reg. format text field

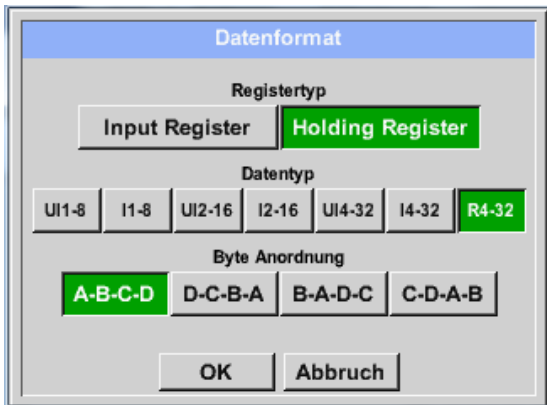

By means of the *input register* and *holding register* buttons, the respective Modbus register type is selected.

With the *data type* and *byte order*, the number format and the order of transmission of the individual number bytes is determined. These must be used in combination.

Supported data types:

| | | | |
|-------------------|---------------------------------|----|--------------------------|
| Data Type: | UI1(8b) = unsigned Integer | => | 0 - 255 |
| | I1 (8b) = signed integer | => | -128 - 127 |
| | UI2 (16b) = unsigned Integer | => | 0 - 65535 |
| | I2 (16b) = signed integer | => | -32768 - 32767 |
| | UI4 (32b) = unsigned Integer | => | 0 - 4294967295 |
| | I4 (32b) = signed integer | => | -2147483648 - 2147483647 |
| | R4 (32b) = floatig point number | | |

Byte Order:

The size of a Modbus register is 2 bytes. For a 32 bit value, two Modbus registers are read out by the METPOINT® BDL portable. Correspondingly, only one register is read out for a 16 bit value.

The Modbus specification only insufficiently defines the byte order with which the values are transmitted. In order to cover all of the possible cases, the byte order is freely adjustable in the METPOINT® BDL portable, and must be adapted to the order of the respective sensor (see sensor/transducer data sheet).

Example: high byte before low byte, high word before low word etc.

Therefore, settings must be defined in accordance with the sensor/transducer data sheet.

Examples :

Holding Register - UI1(8b) - numerical value: 18

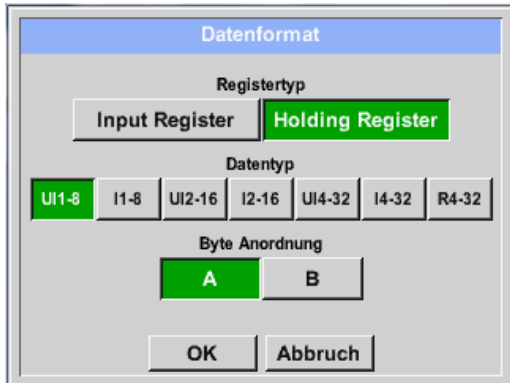

Selection register type *Holding register*, data type *U1(8b)* and byte order *A / B*

| | HByte | LByte |
|------------|---------|---------|
| 18 => | 00 | 12 |
| Data order | 1. byte | 2. byte |
| A | 00 | 12 |
| B | 12 | 00 |

Holding Register – UI4(32) - numerical value: 29235175522 → AE41 5652

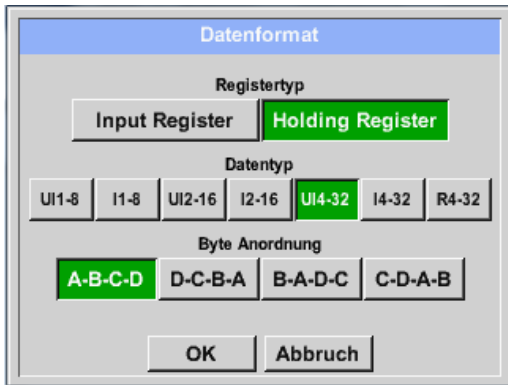

Selection register type *Holding register*, data type *U1 (32b)* and byte order *A-B-C-D*

| | HWord | | LWord | |
|----------------|---------|---------|---------|---------|
| | HByte | LByte | HByte | LByte |
| 29235175522 => | AE | 41 | 56 | 52 |
| Data order | 1. byte | 2. byte | 3. byte | 4. byte |
| A-B-C-D | AE | 41 | 56 | 52 |
| D-C-B-A | 52 | 56 | 41 | AE |

Main menu → Settings → Sensor settings → C1 → Unit text field

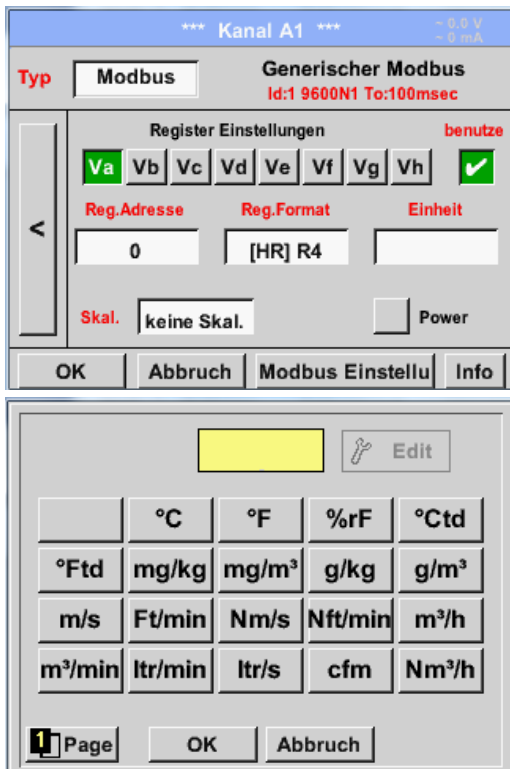

Pressing the *Unit* text field will lead you to a list with the available units.

The unit is selected by pressing the button with the suitable unit. The unit is accepted by actuating the *OK* button.

Changing between the individual list pages is effectuated by pressing the *page* button.

In the event that the required unit is not available, you can create the unit yourself.

For this purpose, one of the free pre-defined *User_x* user buttons must be chosen.

Operation METPOINT® BDL portable

Main menu → Settings → Sensor settings → C1 → Scal. text field

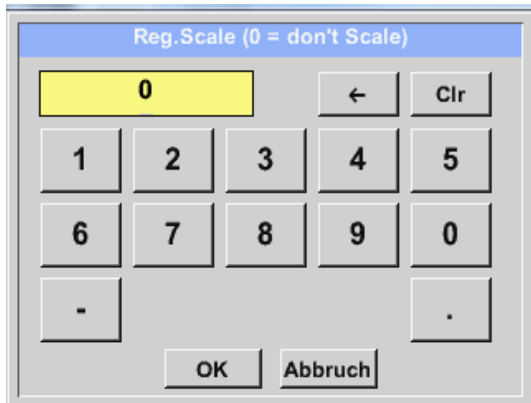

The application of this factor allows for the adjustment of the output value by the latter.

Main menu → Settings → Sensor settings → C1 → OK

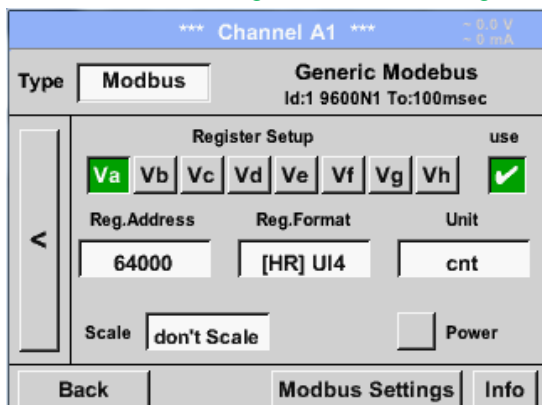

By pressing the **OK** button, the specifications are accepted and stored.

12.3.2.3.3 Modbus settings for the METPOINT® SD23

When connecting the METPOINT® SD23 via Modbus, the following settings are required:

First step: select a free sensor channel

Main menu → Settings → Sensor settings → Select a free channel (example: channel A1)

Second step: select Modbus type

Main menu → Settings → Sensor settings → A1 → Type text field → Select Modbus and confirm with >OK<.

Third step: define a name

Main menu → Settings → Sensor settings → A1 → Name text field

Now, a **name** needs to be entered.

Fourth step: define the Modbus settings

Main menu → Settings → Sensor settings → A1 → Modbus settings

The corresponding Modbus ID can be taken from the data sheet of the sensor (here, for example, 1).

Adjust the other parameters according to the illustration.

Operation METPOINT® BDL portable

Fifth step: define the register

Main menu → Settings → Sensor settings → A1 → Va → Use

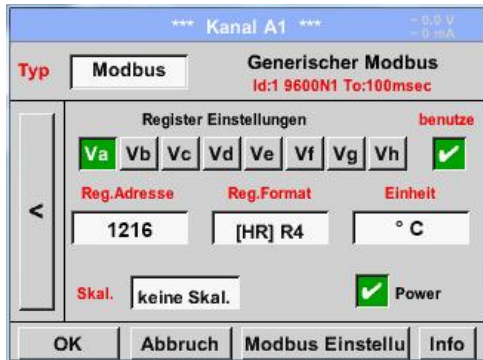

The definition of other registers is implemented in the same manner.

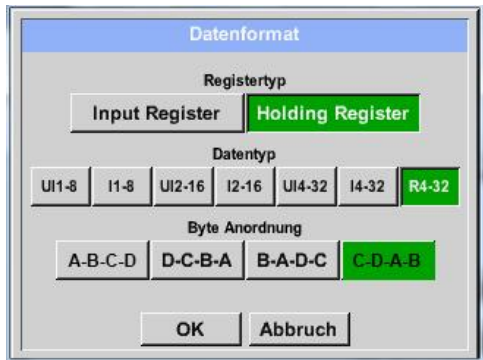

The settings of the reg./data format are the same for all the registers.

Sixth step: enter the Modbus parameters

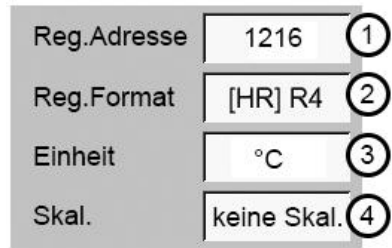

The entry of the Modbus parameters is implemented via the white buttons (1) – (4).

The following parameters can be retrieved via the corresponding registers:

| Register | Designation | Address register | Reg. format | Unit | Scal. |
|----------|--------------------|------------------|-------------|------|----------|
| Va | Temperature | 1216 | [HR] R4 | °C | No scal. |
| Vb | Rel. humidity | 1152 | [HR] R4 | % rH | No scal. |
| Vc | Dew/freezing point | 1536 | [HR] R4 | °Ctd | No scal. |
| Vd | Dew point | 1472 | [HR] R4 | °Ctd | No scal. |

12.3.2.3.4 Data logger settings

Main menu → Settings → Logger settings



In the uppermost row, the pre-defined *time intervals* 1, 2, 5, 10, 15, 30, 60, and 120 seconds can be chosen for the recording.

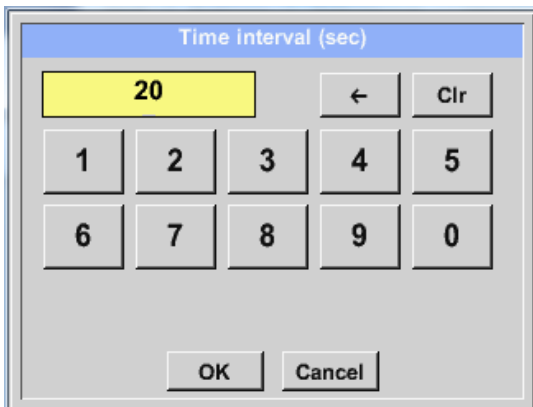

A deviating individual *time interval* can be entered into the text field with the white background on the upper right where the currently set *time interval* is always indicated (here, for example, 20 seconds).

Note:
The largest possible *time interval* is 300 seconds (five minutes).

Note:

When more than 12 measuring data are simultaneously recorded, the smallest possible data logger interval is two seconds.

When more than 25 measuring data are simultaneously recorded, the smallest possible data logger interval is five seconds.

Main menu → Settings → Logger settings → Force-new-logger-file button

or

Main menu → Settings → Logger settings → Force-new-logger-file button → Comment text field

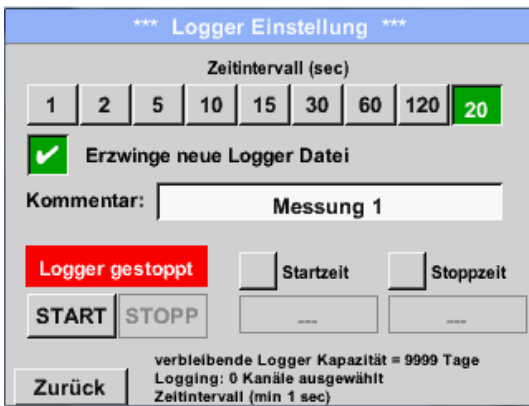
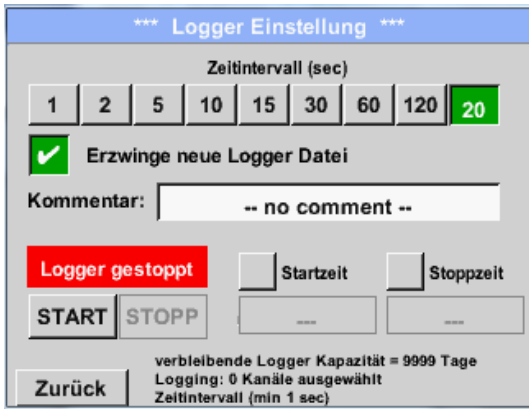

By pressing the *Force new logger-file* button, a new recording file is created, and with the selection of the *Comment* text field, a name or comment can be entered.

Important:

When a new recording file is to be created, the *Force-new-logger-file* button must be activated.

Otherwise, the recording file that was created last will be used.

Main menu → Settings → Logger settings → Start time button

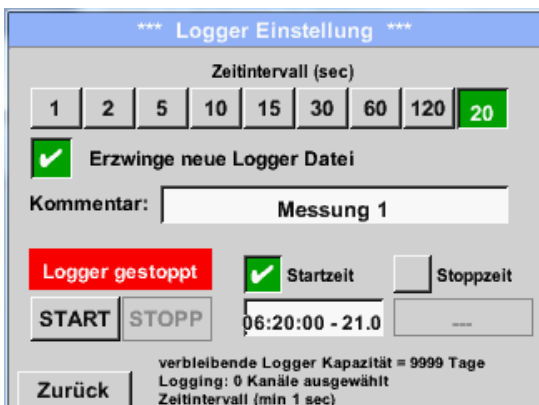

By pressing the *Start time* button and subsequently pressing the date/time text field below, the date and the *start time* of the data logger recording can be set.

Note:

When activating the *start time*, the latter will automatically be set to the current time plus one minute.

Main menu → Settings → Logger settings → Stop time button

*** Logger Einstellung ***

Zeitintervall (sec)

1 2 5 10 15 30 60 120 20

Erzwinge neue Logger Datei

Kommentar:

Logger gestoppt Startzeit Stoppzeit

START STOPP 06:20:00 - 21.0 07:20:00 - 21.0

Zurück

verbleibende Logger Kapazität = 9999 Tage
Logging: 0 Kanäle ausgewählt
Zeitintervall (min 1 sec)

By pressing the *Stop time* button and subsequently pressing the date/time text field below, the date and the time for the end of the data logger recording can be set.

Note:

When activating the *stop time*, the latter will automatically be set to the current time plus one hour.

Main menu → Settings → Logger settings → Start time button/Stop time button → Date/time text field

Stoppzeit

07 : 20 : 00 21 · 06 · 13 Cal

1 2 3 4 5

6 7 8 9 0

OK Abbruch

After having pressed the *Date/time text field*, the input window will appear, in which the zone of the time or date which is highlighted in yellow can always be set or changed.

Operation METPOINT® BDL portable

Main menu → Settings → Logger settings → Start time button/Stop time button → Date/time text field → Cal button

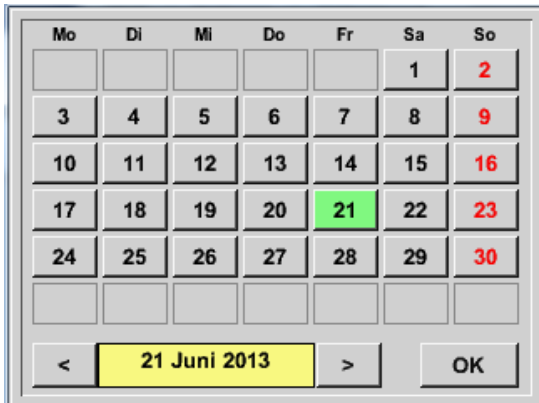

By means of the *Cal* button, the desired date can easily be chosen from the calendar.

Main menu → Settings → Logger settings → Start button



Subsequent to the *start* or *stop time* activation and the implemented settings, the *Start* button is pressed and the data logger is on *active*.

The data logger will start recording at the set time!

Main menu → Settings → Logger settings → Start button/stop button



The data logger can also be activated and deactivated without activated time settings, namely by means of the *Start* and *Stop buttons*.

On the lower left, it is indicated, how many values are being recorded, and for how long recording can be continued.

Note:
Settings cannot be changed when the data logger is active.

Important:

When a new recording file is to be created, the *Force-new-logger file* button must be activated. Otherwise, the recording file that was created last will be used.

12.3.2.3.5 Device settings

Main menu → Settings → Device settings



Overview of the device settings

12.3.2.3.5.1 Language

Main menu → Settings → Device settings → Language

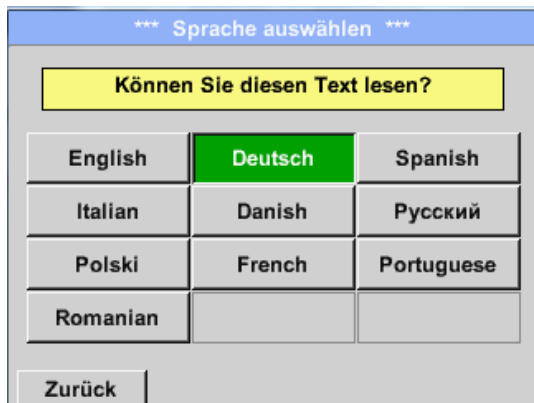

Here, one out of 10 languages can be selected for the METPOINT® BDL portable.

12.3.2.3.5.2 Date & time

Main menu → Settings → Device settings → Date & time



By pressing the *Time zone* text field and entry of the correct *UTC*, the correct time can be set worldwide.



Changeover to summer/winter time is implemented by pressing the *Summer time* button.

12.3.2.3.5.3 SD card

Main menu → Settings → Device settings → SD card → Reset logger data base

Main menu → Settings → Device settings → SD card → Erase SD card



By pressing the *Reset logger data base*, the currently stored data are blocked from use in the DP500. However, the data remain stored on the SD card, and are available for external use.

By pressing the *Erase SD card* button, all of the data are completely deleted from the SD card.

Operation METPOINT® BDL portable

12.3.2.3.5.4 System update

Important!

A system update can only be implemented when the power supply plug is connected in order to ensure the continuous power supply during the update.

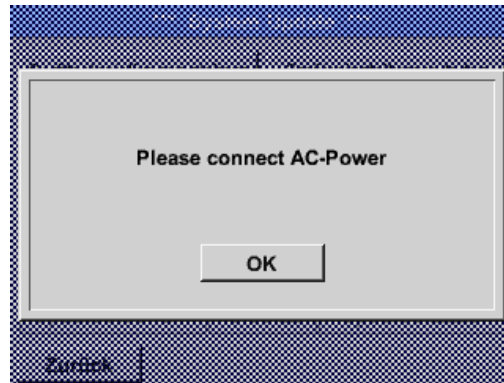

Main menu → Settings → Device settings → System → System update

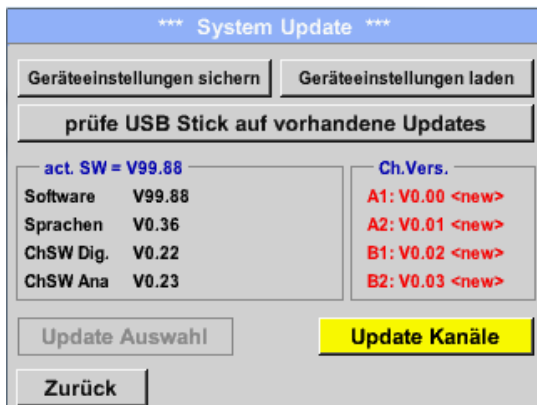

Overview of the *system update* functions

12.3.2.3.5.4.1 Securing the device settings

Main menu → Settings → Device settings → System update → Securing the device settings



Stores the *channel and system settings* in an XML format on a USB stick.

12.3.2.3.5.4.2 Check for available updates (USB)

Main menu → Settings → Device settings → System update → Check USB stick for available updates

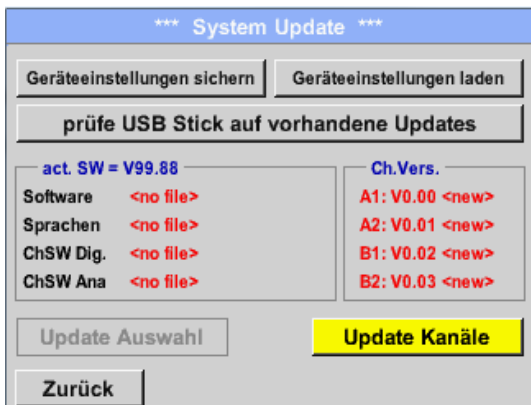

When, after having pressed the *Check USB stick for available updates* button, the following messages (no file) appear in the window, the METPOINT® BDL portable is not correctly connected with the USB stick or no data are available.

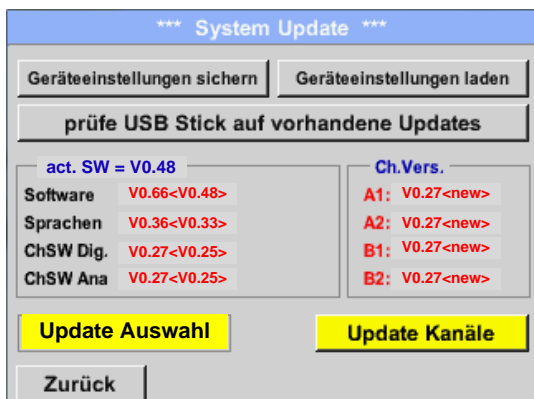

When the METPOINT® BDL portable is correctly connected with the USB stick and newer versions are found, these are indicated.

To the right, the current (old) and the newly available (new) versions are shown.

Main menu → Settings → Device settings → System → System update → Update selection

Main menu → Settings → Device settings → System → System update → Update channels

Important:

If, subsequent to the update, the *Restart* button appears, it must be pressed to restart the METPOINT® BDL PORTABLE!

Main menu → Settings → Device settings → System → System update → Update channels

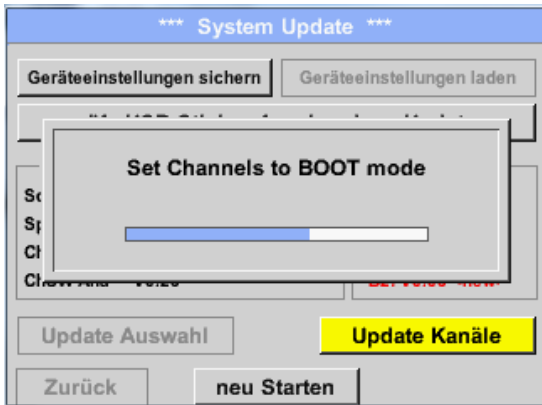

Update for the *channels* of the METPOINT® BDL portable.

Important:

If, subsequent to the channel update, the *Restart* button appears, it must be pressed to restart the METPOINT® BDL portable!

The update of the channels may require a double run and a new start of the system. In this case, a message (pop-up) will be displayed at the restart.

12.3.2.3.5.4.3 Loading device settings

Main menu → Settings → Device settings → System → Loading device settings

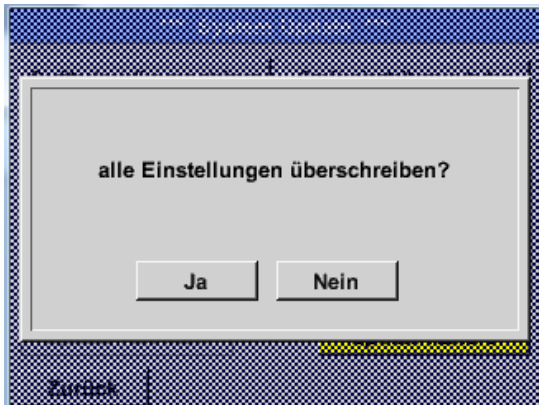

By means of the *Loading device settings* button, the channel and system settings can be reset to the status of when it was last saved.



Important:
When the channel and system settings have been reset, the *OK* button and afterwards the *Restart* button must be pressed.

12.3.2.3.5.5 Reset factory defaults

Main menu → Settings → Device settings → factory def. reset → Reset to defaults

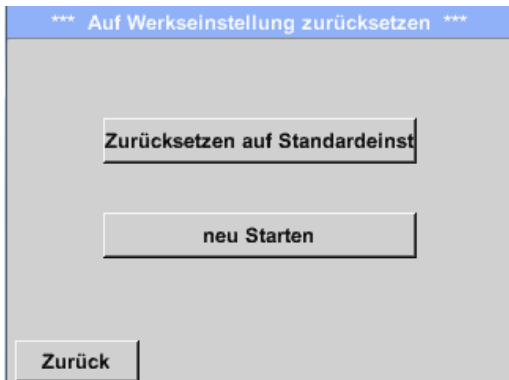

If required, the METPOINT® BDL portable can be re-booted by pressing the *Restart*-button.

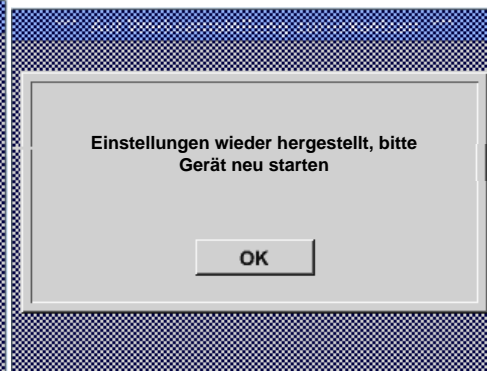
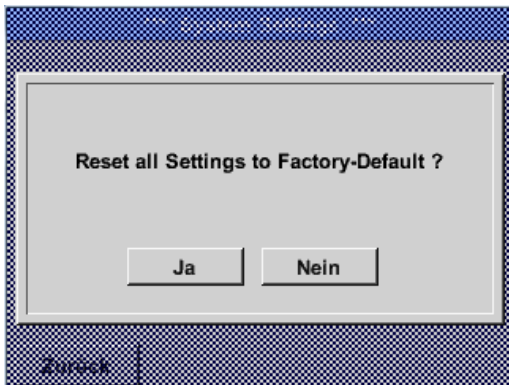

12.3.2.4 Calibrating the touch screen

Main menu → Settings → Calibration touch screen

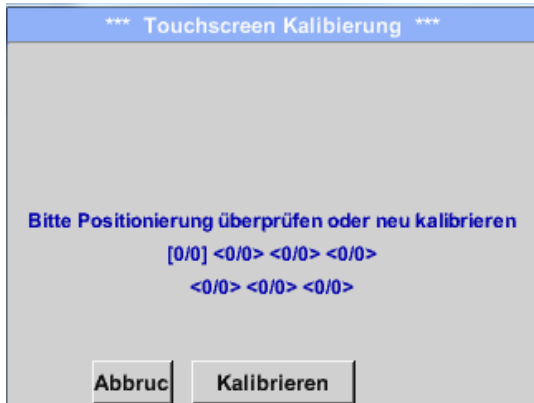

If required, the screen calibration can be changed here.

Press *Calibrate*, and a calibration cross will appear 1. on the upper left, 2. on the lower right, and 3. in the middle. These crosses must be pressed consecutively.

When calibration is completed and the indication is averaged, confirm with *OK*.

If this is not the case, calibration can be repeated by means of *Cancel* and by pressing *Calibrate* again.

12.3.2.4.1 Brightness

Main menu → Settings → Brightness

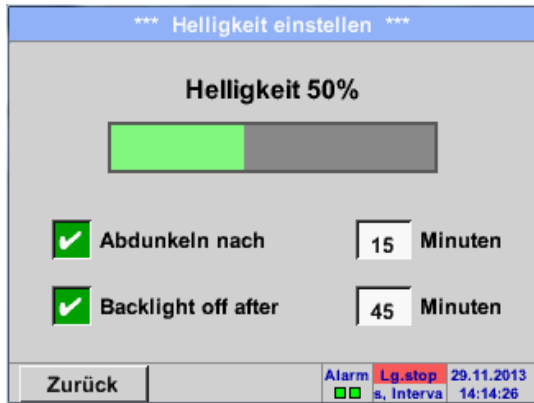

Here, the desired *brightness* (15 ... 100%) of the display can directly be set.

E.g.: *brightness* to 50%.

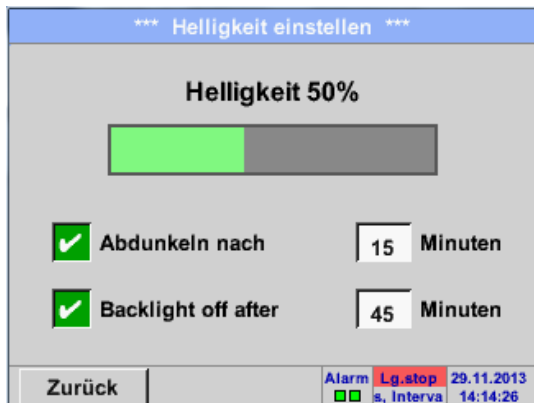

By means of the *Darken-after* button, the *brightness* can be reduced to a minimum at the end of a time interval to be defined (here after 15 minutes), or completely switched off.

In addition, in order to preserve battery life, the display backlight can be completely switched off by means of the *Backlight off after* button at the end of the defined time interval (here after 45 minutes)

As soon as the dimmed screen is activated again, the *brightness* automatically goes back to the value that was last set prior to dimming.

Note: at the first touch, the *brightness* in our example is reset to 50%. Afterwards, "normal" functional operation is possible again.

Important: when the *Darken-after* button is not activated, the backlighting is continuously on, at the currently set *brightness*.

12.3.2.4.2 Cleaning

Main menu → Settings → Cleaning



This function can be used to clean the touch panel during the running measurements.

If one minute does not suffice for the cleaning process, the procedure can be repeated at all times.

If the cleaning process is completed before, it can be stopped by pressing the *Long-press-for-canceling* button for one to two seconds.

12.3.2.4.3 System overview

Main menu → Settings → System overview

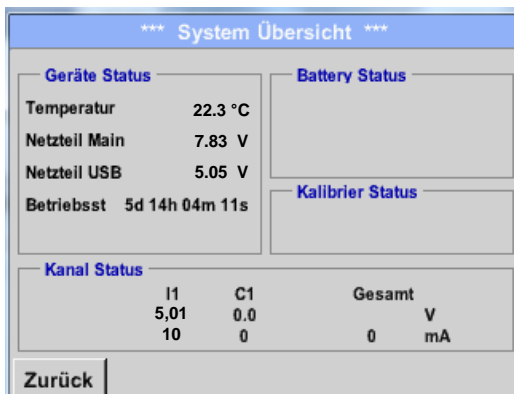

The *system overview* menu item provides information on the applied voltages and currents of the individual and the entire *channels*, as well as on the voltage supply of the *power supply units*.

Moreover, one can always see, by means of the *operating hours*, for how long the METPOINT® BDL portable was in operation on the whole.

12.3.2.4.4 About METPOINT® BDL portable

Main menu → Settings → About METPOINT® BDL portable



Short description of the *hardware* and *software version*, and the *serial number* of the METPOINT® BDL portable.

Under *options*, you can also acquire two different functions, if this was not done during the ordering.

12.3.2.5 Graphics

Main menu → Graphics

Caution:

In the *graphics*, only those records can be displayed which are already completed!

The currently running recordings can be observed in *graphics/current values*.

(see Chapter 7.3.2.3 [Grafik/Aktuelle Werte](#))

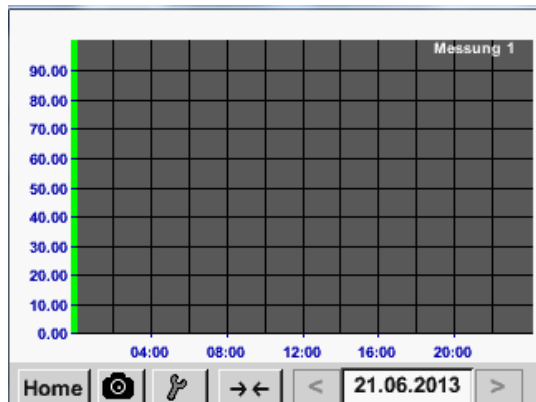

During the running measurement, no values are displayed!

Zoom and scroll possibilities in the time range of the *graphics*:

→ ← Maximally, an entire day can be displayed (24h).

← → The smallest possible range is displayed, depending on the time interval of the record.

Additional zoom and scroll possibilities in *graphics* and *graphics/current values*:

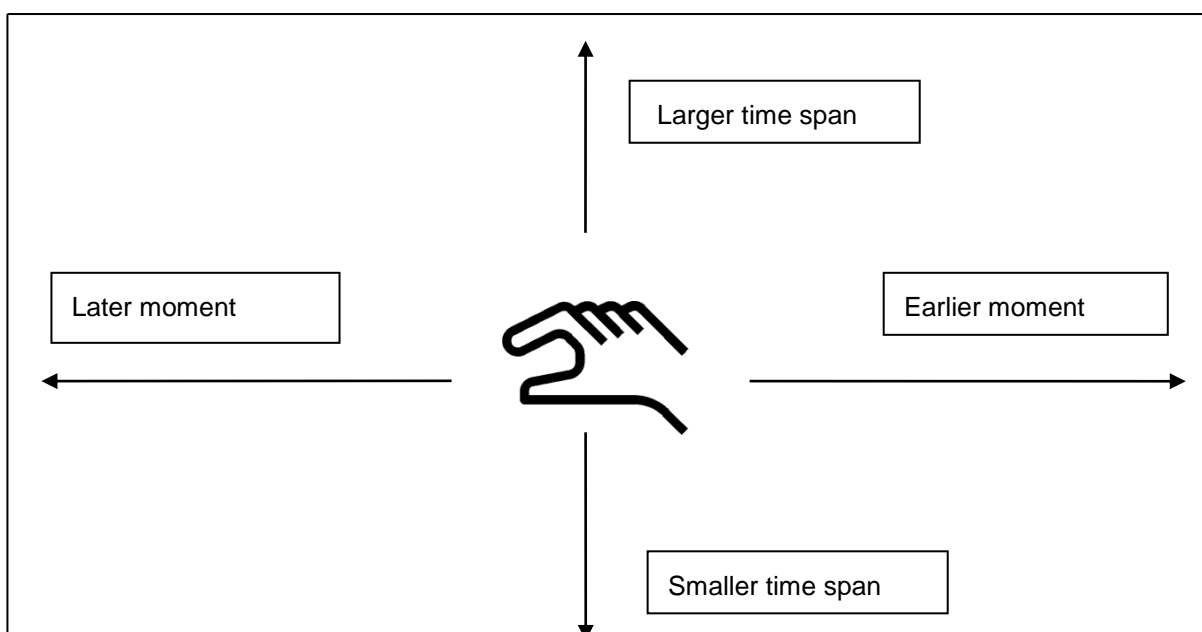

Main menu → Graphics → Date text field



By pressing the *Date* text field (bottom middle), the calendar will appear, from which the suitable date can easily be selected.

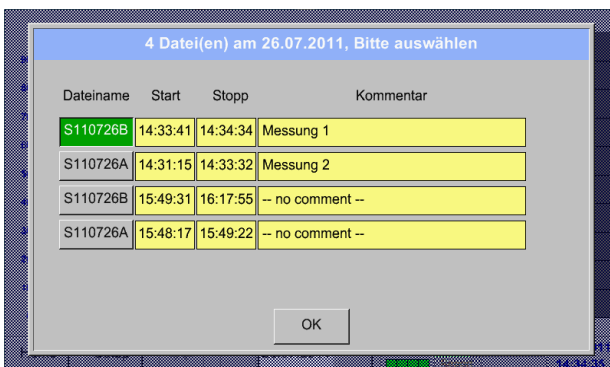

Here, the stored measuring data can be selected according to the *time (start and stop)*, *comment*, and *file name* (with an English date).

Main menu → Graphics → Set-up

In the *set-up*, you can apply two different assignments to the y-axis, and select a *unit*, the y-axis scaling (*min, max, grid*), several channels (*curve*), and a *color*.



1.

The *left* y-axis is already activated, and a *color* can now be assigned to it.

Note:

The grid setting is already possible at this moment but it is more useful at a later moment, for example when the recording was selected!

Main menu → Graphics → Set-up → Unit text field



Here, the *unit* of the record to be displayed is selected from the menu.

Main menu → Graphics → 

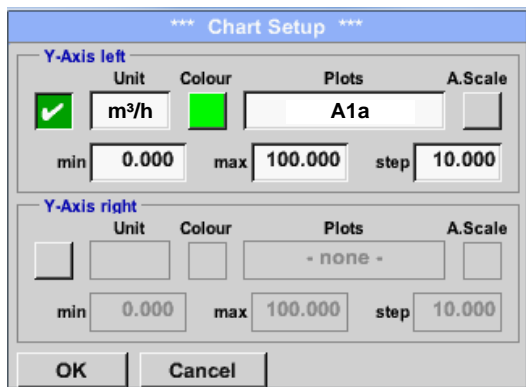

Now, the y-axis scaling with *min*, *max*, and *grid* can be set.

By means of the *A.Scale* button, a calculated autoscaling can be defined.

Assignments to the remaining y-axis are implemented in the same manner!

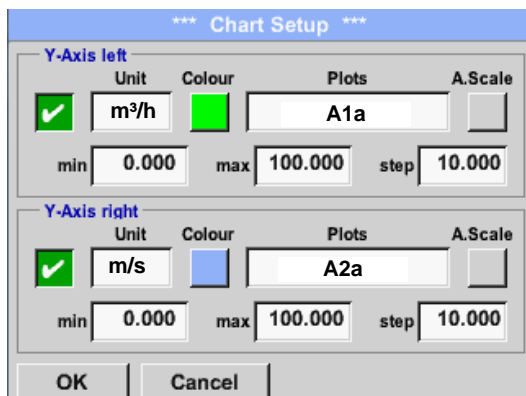

Two different grid settings with different *units* and *colors*.

Main menu → Graphics

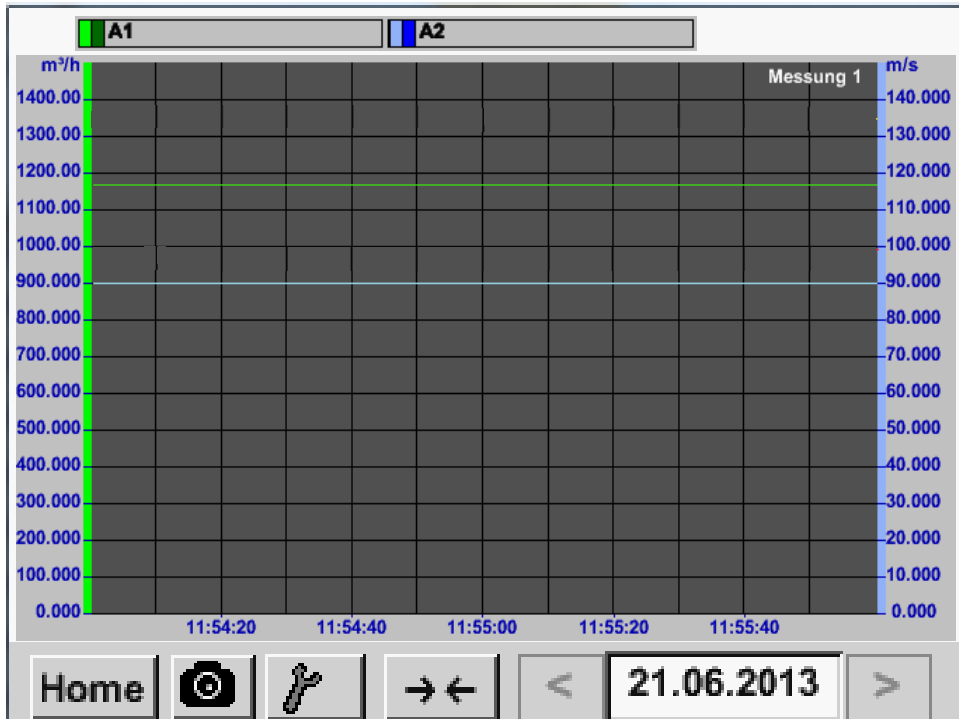

12.4 Graphics/current values

Main menu → Graphics/current values

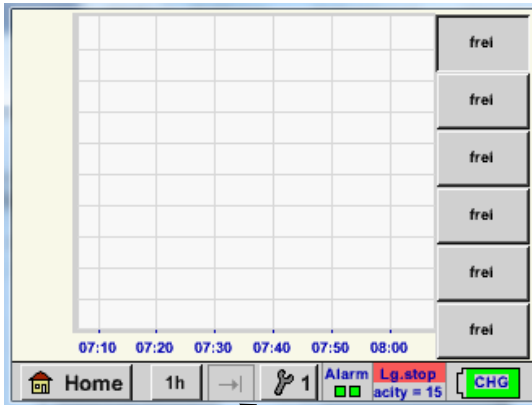

Here, one or several channels can be selected for the recording and representation of measuring data, for example from a dew point sensor or several different sensors.

After having pressed this button, the currently recorded measuring data are displayed in the current time range.

Fast access to the pre-defined time ranges of 24 h, 8 h, 1 h, 15 min, and 2 min. At the push of a button, the graphics for the selected time range are displayed.

Main menu → Graphics/current values →  #1- #6

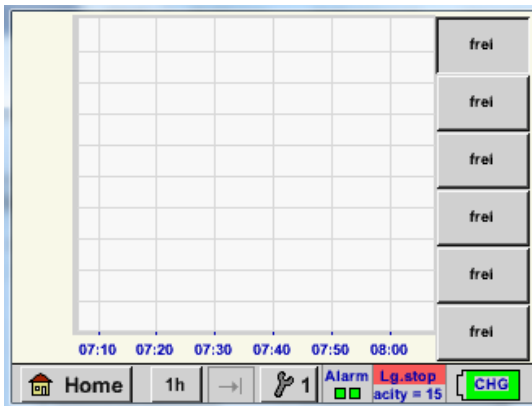

Under this menu item, up to six measured values can be activated simultaneously and viewed under *Main menu → Graphics/current*.



Here, channel C1 was selected.
For each channel, one value for the representation in the *graphics* can be selected.
In addition, like in the *Main menu → Graphics*, a *color* and the y-axis scaling (*min*, *max*, *grid*) can be determined.

Main menu → Graphics/current values

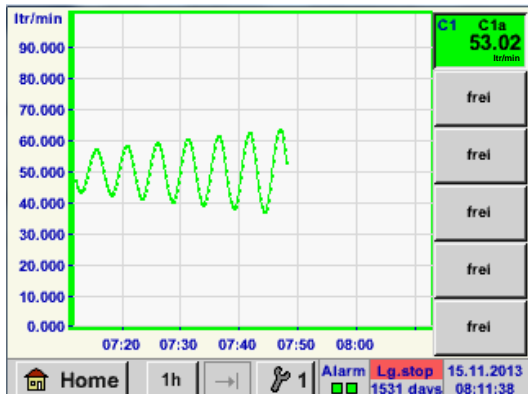

Channel C1:

The flow volume as *graphics*.

When several channels are occupied, all the graphics are displayed. It must be observed that only the y-axis of the selected channel is displayed in each case.

When no y-axis scaling is entered into the set-up, *min* is set to 0, *max* to 100, and *grid* to 10.

Assignments to the remaining set-ups are implemented in the same manner!

Operation METPOINT® BDL portable

12.4.1.1 Channels

Main menu → Channels



The *Channels* view shows the current measured values of the connected sensor. In the event that the adjusted alarm limits are exceeded or underrun, the respective measured value flashes yellow (*alarm-1*) or red (*alarm-2*).

Main menu → Channels → C1

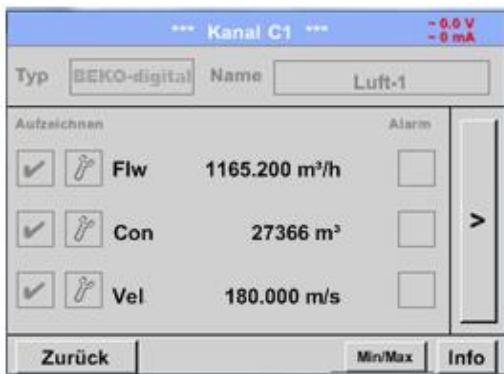

The individual channels can be selected and the settings viewed and checked, but **no** changes can be implemented here.

Note:
Changes must be effectuated in the *settings!*

12.4.1.1.1 Min./max. function

This functions allows for the readout of the min. or max. values of the running measurement for each connected sensor. The start of recording is the setting and connection of the sensor, however, it is possible at all times to reset the min. and max. values.

Main menu → Channels → I1 → **Min/Max**

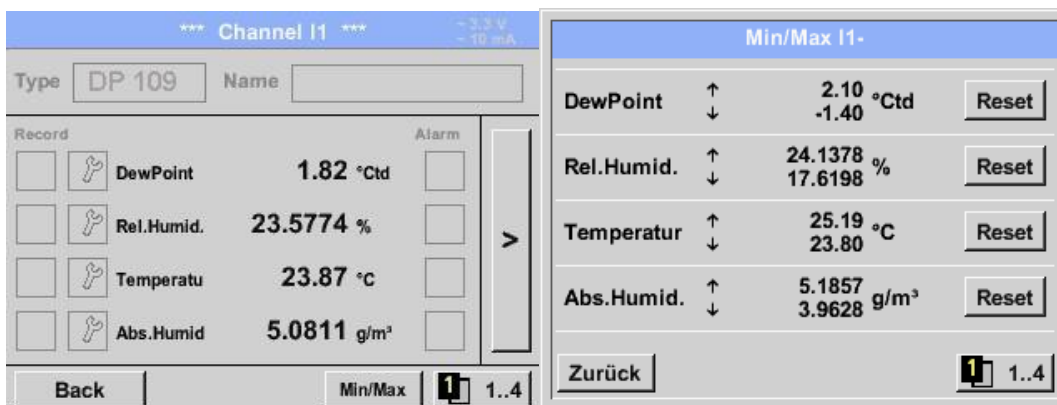

↑ = Max, value ↓ = Min. value

Main menu → Channels → C1 → **Min/Max** → Dew point **Reset**

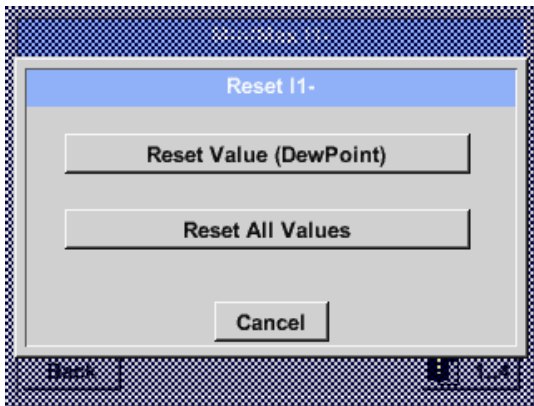

It is possible to reset an individual measured value such as the pressure dew point here, or all of the *min. and max.* values of the sensor, if required.

Reset of the individual value by pressing the *Reset Value* button or of all the values by pressing the *Reset All Values* button.

Operation METPOINT® BDL portable

12.4.1.2 Current values

Main menu → Current values

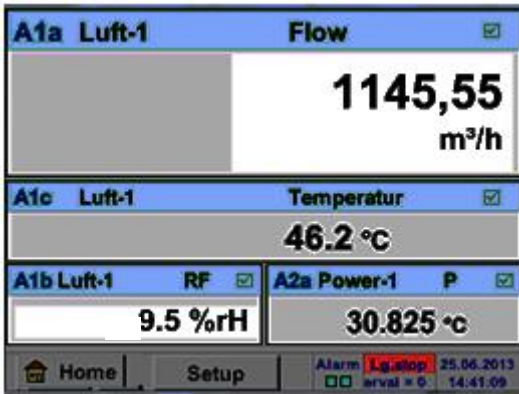

The *current values* view allows for the indication of 1 to 5 freely selectable measured values.

In the event that the adjusted alarm limits are exceeded or underrun, the respective measured value flashes yellow (*alarm-1*) or red (*alarm-2*).

Note:
Changes regarding the indication must be effectuated under *set-up!*

Main menu → Current values → Setup → Next layout

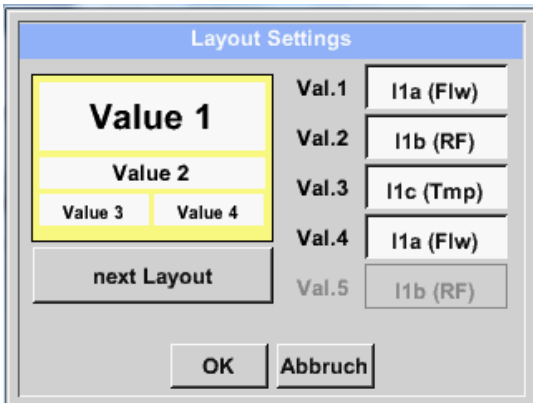

Here, the desired layout can be selected by pressing the *Next Layout* button.

It is possible to choose between six different layouts with the indication of between one and five measured values. Variants see below.

By pressing the fields with a white background (*Val.1 to Val.5*), the required measured values can be selected.

Possible variants:

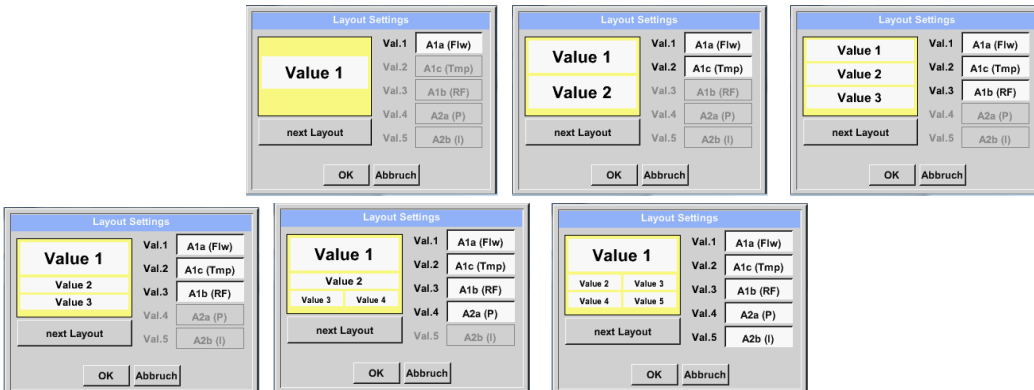

12.4.1.3 Alarm overview

Main menu → Alarm overview

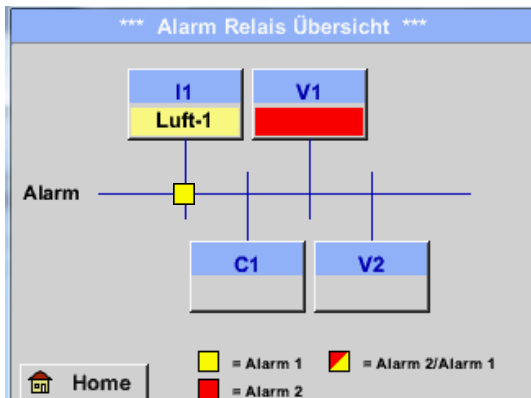

In the *alarm overview*, you can immediately see whether the alarm is an *alarm-1* or an *alarm-2*.
 This is also evident in other menu items:
Main menu → Channels and in *Main menu → Settings → Sensor settings*
 The channel indication flashes yellow for an *alarm-1* and red for an *alarm-2*.
 Moreover, one can see which pop-ups were set for which channel as an *alarm-1* and/or as an *alarm-2*.

This is an *Alarm-1* for channel I1!

Main menu → Alarm overview → C1

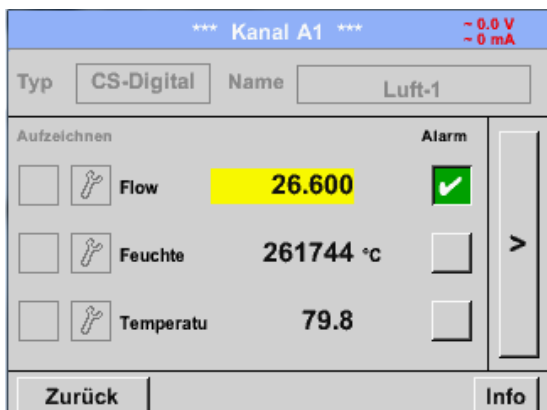

As with *Main menu → Channels*, individual channels can be selected here.
 In the *alarm overview*, it is quickly visible which measured value has exceeded or underrun the alarm range.
Note:
 The alarm parameters can also be set and/or changed here.

Operation METPOINT® BDL portable

12.4.1.4 Export data

With *export data*, recorded data can be transmitted to a USB stick.

Main menu → Export data



With *Export logger data* and *Export system settings*, the recorded measuring data and the stored settings can be transmitted to a USB stick.

Main menu → Export data → Export logger data



By means of the *Selection* buttons, a period between *start* and *end* can be set. Stored measured data within this period are exported.

Main menu → Export data → Export logger data → Selection



The selected date is always highlighted in green, and the date figures of the Sundays are red, as is the case in a calendar.

On days on which the measuring data were recorded, the date figures are optically raised.



When several measurements were recorded on the same day, these will appear subsequent to having selected the date with **OK**.

The desired record can easily be chosen now.

Main menu → Export data → Export logger data → Exporting

The measuring data of the selected period are exported to a USB stick.

Main menu → Export data → Export system settings

By means of *export system settings*, all the available sensor settings can be exported to a USB stick.

Virtual channels (optional)

13 Virtual channels (optional)

The "virtual channels" option offers two additional channels (no HW channels) for the description of calculations regarding HW channels, virtual channels, and freely definable constants with each other.

Per each virtual channel, up to eight value calculations with three operands each and 2 operations can be realized.

Possible applications are the calculations of:

- The specific performance of a system
- Total consumption of the system (several compressors)
- Energy costs etc.

13.1 Activate the option "virtual channels"

After having acquired the "virtual channels" option, the latter needs to be activated first.

Main menu → Settings → Via METPOINT® BDL portable

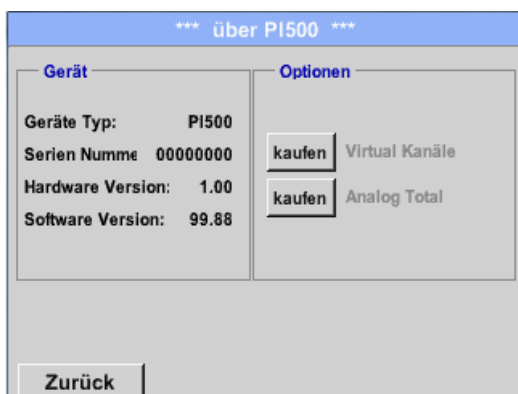

By pressing the *Buy* button for "virtual channels", you will be requested to enter the activation code.

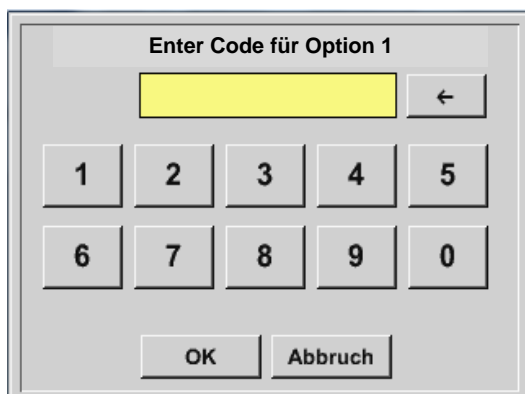

Please enter your activation code into the text field and activate it by pressing the *OK* button.

13.2 Virtual channels setting

Main menu → Settings → Sensor settings → Virtual channels

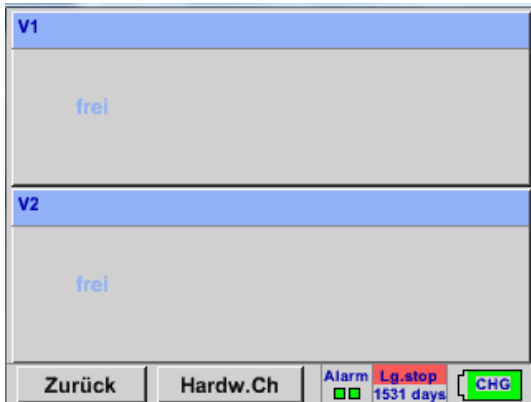

After having activated the "virtual channels" button in the sensor setting menu, an overview of the available four channels will appear.

Note:
Channels are not preset as a standard.

13.2.1 Selection of the sensor type

Main menu → Settings → Sensor settings → Virtual channels → V1

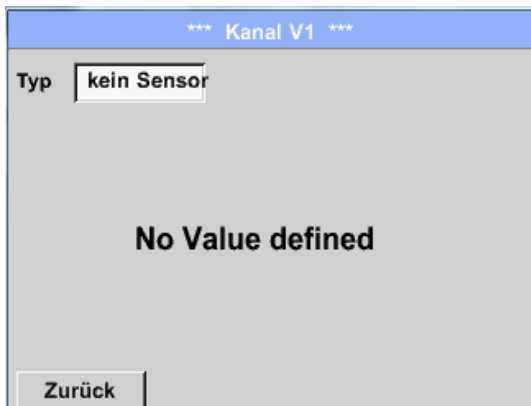

If no sensor was configured yet, the *Type no sensor* will appear.

Pressing the text field *Type no sensor* will enable you to go to the selection list of sensor types (see next step).

Main menu → Settings → Sensor settings → Virtual channels → V1 → Type text field

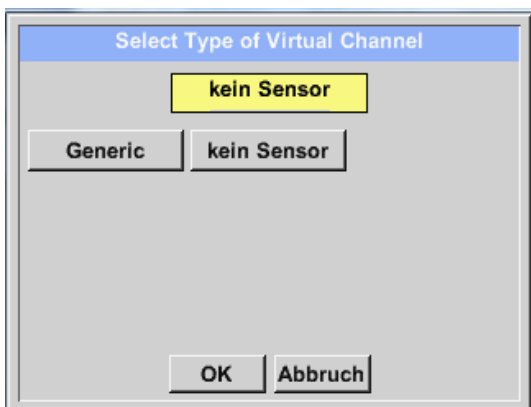

If no sensor was configured yet, the *Type no sensor* will appear.

By pressing the **Generic** button, the virtual channel is selected.

By pressing the **No sensor** button, the channel is reset.

The selection is confirmed by pressing the **OK** button.

Virtual channels (optional)

Main menu → Settings → Sensor settings → Virtual channels → V1 → Name text field

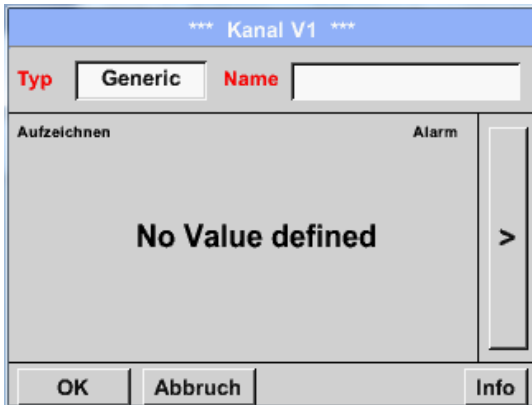

Now, a *name* can be entered.

13.2.2 Configuration of the individual virtual values

Per each individual channel, up to eight virtual values can be calculated which need to be activated separately:

13.2.3 Activation of the individual virtual values

Main menu → Settings → Sensor settings → Virtual channels → V1 → Right arrow (2nd page) → V1a → Use

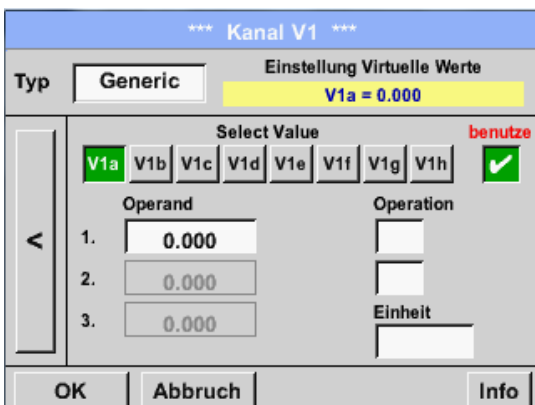

A virtual value is activated by pressing the respective *Value button*, for example *V1a* with subsequent actuation of the *Use button*.

13.2.4 Definition of the operands

Main menu → Settings → Sensor settings → Virtual channels → V1 → Right arrow (2nd page) → 1st operand

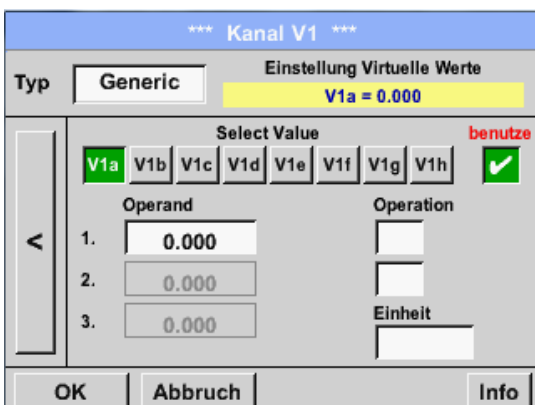

By pressing the *1st operand* field, you will go to a selection list with the available hardware channels, virtual channels, and constant values.

Virtual channels (optional)

Main menu → Settings → Sensor settings → Virtual channels → V1 → 1st operand → C1

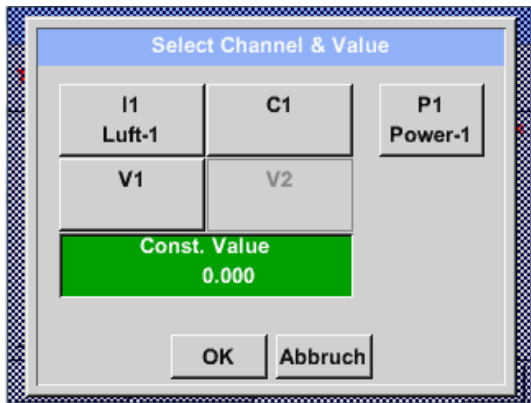

By pressing a hardware or virtual channel button, e.g. *I1*, a selection list will open, showing the measuring channels or measured values that are available per channel, including defined virtual channels.

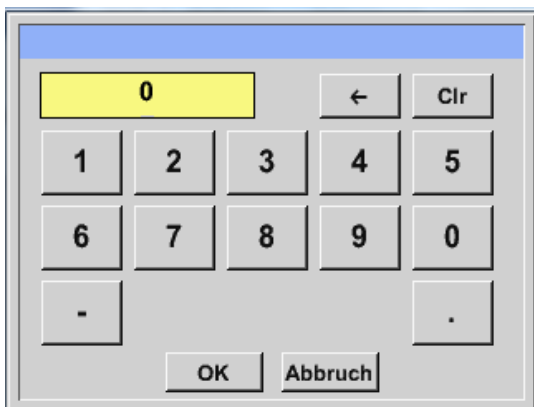
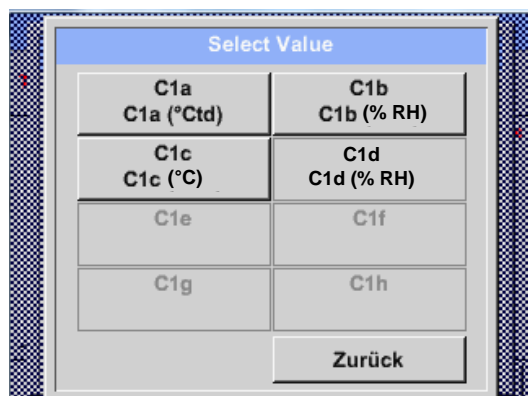

By pressing the desired channel button, e.g. *C1b*, the selection is accepted.

The same procedure applies analogously to all op

If the *Const. value* button was pressed, the value needs to be determined via the numeric keypad. By pressing the *OK* button, the value is accepted.

By means of buttons *←* and *Clr*, the values can be corrected.

Button *←* erases the last character

Button *Clr* erases the entire value

Virtual channels (optional)

13.2.5 Definitions of the operations

Main menu → Settings → Sensor settings → Virtual channels → V1 → Right arrow (2nd page) → 1st operation



By pressing the text field *1st operation*, a list with the available mathematic operands will appear.

Selection and acceptance of the operand is implemented by pressing the desired button.

Actuating the *Not used* button will deactivate the operation with the related operator.

The same procedure applies analogously to both operators (1st operation and 2nd operation)

13.2.6 Definition of the unit

Main menu → Settings → Sensor settings → Virtual channels → V1 → Right arrow (2nd page) → Unit

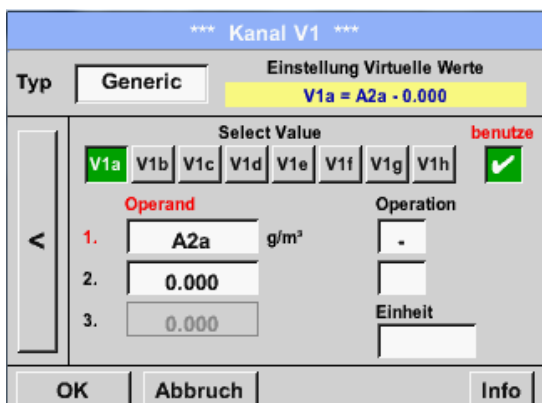

By pressing the text field *Unit*, a list with the available units will appear.

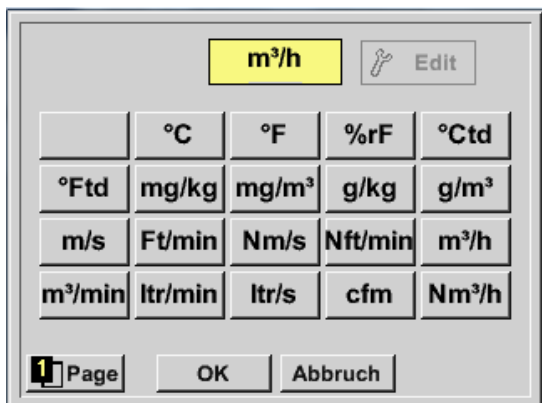

The selection of the unit is implemented by pressing the desired unit button. The unit is accepted by pressing the *OK* button.

A change between the individual list pages is effectuated by pressing the *Page* button.

In the event that units cannot be selected, you can create the unit yourself.

For this purpose, one of the free pre-defined *User_x* user buttons must be chosen. Paging is effectuated with the *Page* button.

Virtual channels (optional)

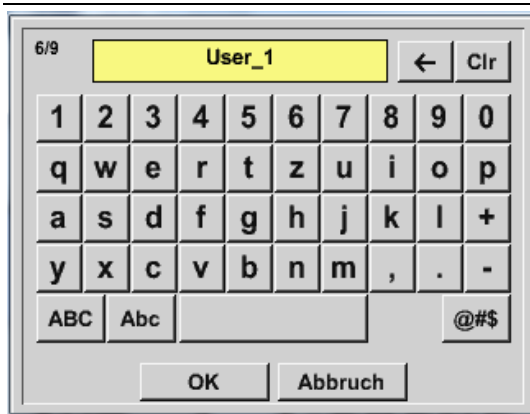

To enter the new unit, press the *Edit* button.

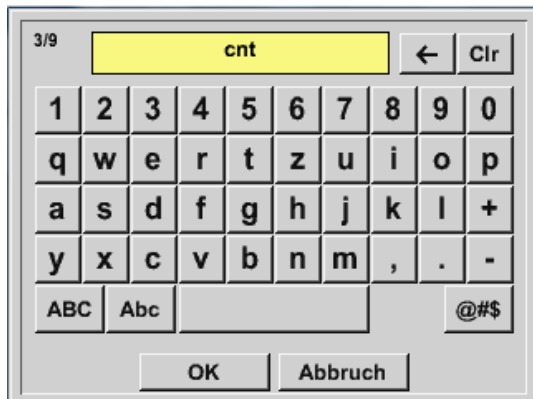

Define the unit and accept with *OK*.

By means of buttons *←* and *Clr*, the entry can be corrected.

Button *←* erases the last character

Button *Clr* erases the entire value

Important

When all of the values and operators are applied, calculations with three values and 2 operands are possible, which are solved according to the following formula:

Example: $V1a = (1^{st} \text{ operand } 1^{st} \text{ operation } 2^{nd} \text{ operand}) 2^{nd} \text{ operation } 3^{rd} \text{ operand}$

$$V1a = (A1c - A2a) * 4.6$$

Virtual channels (optional)

13.2.7 Resolution of the decimal places – designating and recording data values

Main menu → Settings → Sensor settings → Virtual channels → V1 → Tool button

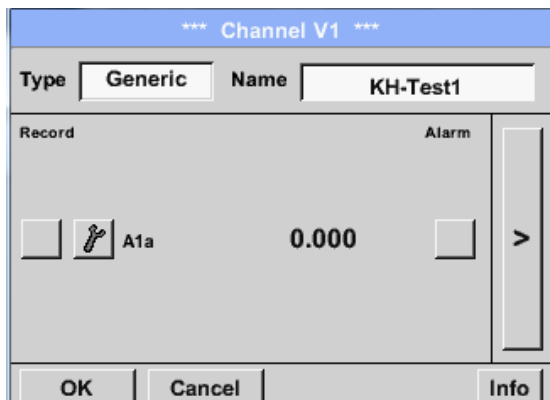

The *resolution* of the decimal places, *short name* and *value name* can be found below the *Tool button*.

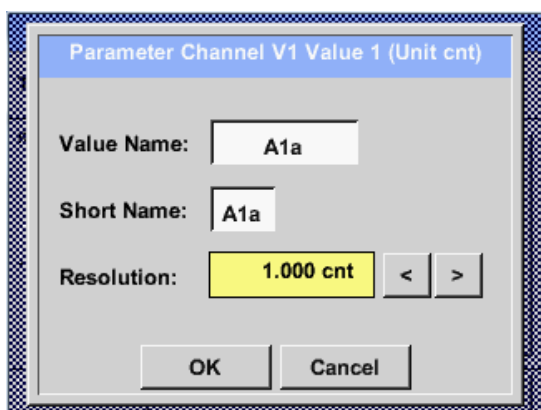

For the *value* to be recorded, a *name* with 10 characters can be entered in order to simplify its identification at a later moment in the menu items *Graphics* and *Graphics/current values*.

Otherwise, the designation would be *V1a*, for example.

V1 is the channel name and *a* the first measured value in the channel, *b* would be the second, and *c* the third.

The *resolution* of the decimal places is easily adjustable by pressing right and left (0 to 5 decimal places).

Main menu → Settings → Sensor settings → Virtual channels → V1 → Recording button

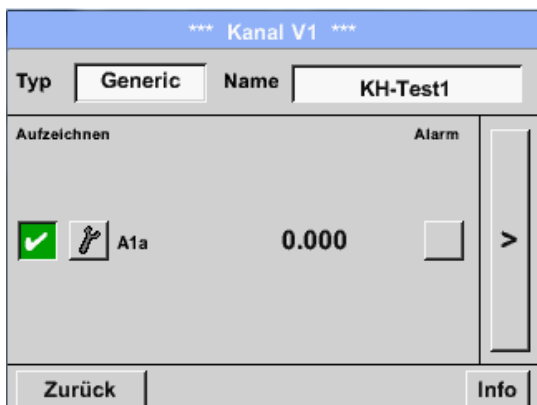

With the *Recording* buttons, the measuring data are selected which are stored at an **activated data logger**.

Caution:

Prior to recording the selected measuring data, the data logger must be activated subsequent to the completion of the settings (see Chapter [7.3.2.1.3 Logger-Einstellung \(Datenlogger\)](#)).

See also Chapter [7.3.2.1.2.2 Messdaten bezeichnen](#) und [7.3.2.1.2.3 Messdaten aufzeichnen](#)

14 Analogue total (optional)

The "analogue total" option offers the possibility of a consumption determination also for sensors with analogue outputs, e.g.: 0-1/10/30 V or 0/4 – 20 mA.

14.1 Activating the "analogue total" option

Subsequent to the acquisition of the "analogue total" option, the latter first needs to be activated.

Main menu → Settings → via METPOINT® BDL portable

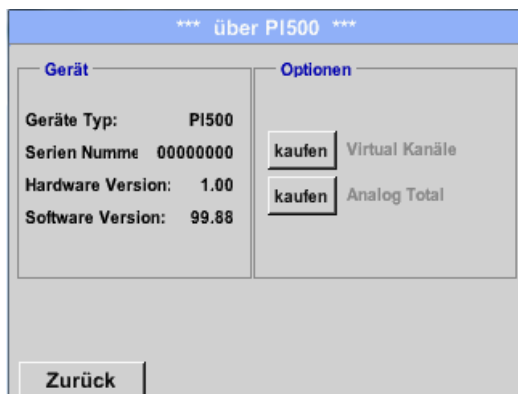

By pressing the *Buy* button for "analogue total" you will be requested to enter the activation code.

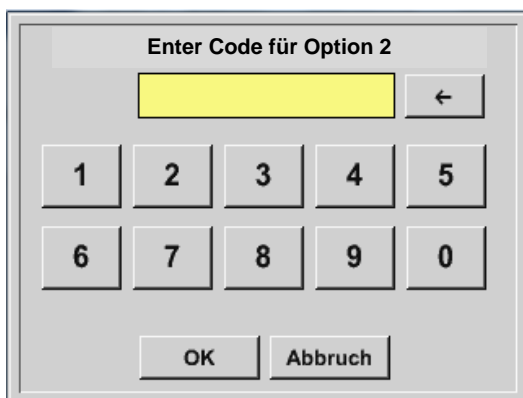

Please enter your activation code into the text field, and activate by pressing the *OK* button.

Analogue total (optional)

14.2 Selection of the sensor type

See also Chapter [7.3.2.1.2.8 Konfiguration von Analogsensoren](#)

Main menu → Settings → Sensor settings → C1

Main menu → Settings → Sensor settings → C1 → Type text field

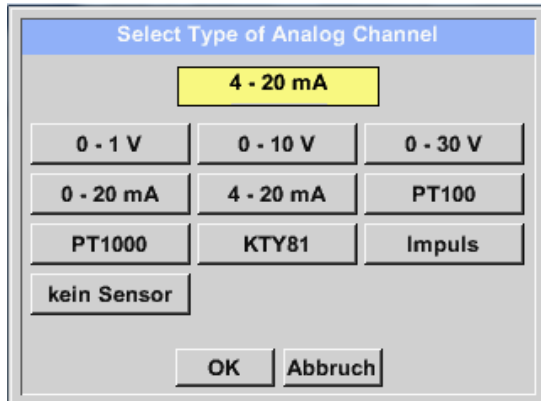

Selection of the required sensor type by pressing the respective button, here, for example 4-20 mA.

Confirmation and acceptance with the **OK** button.

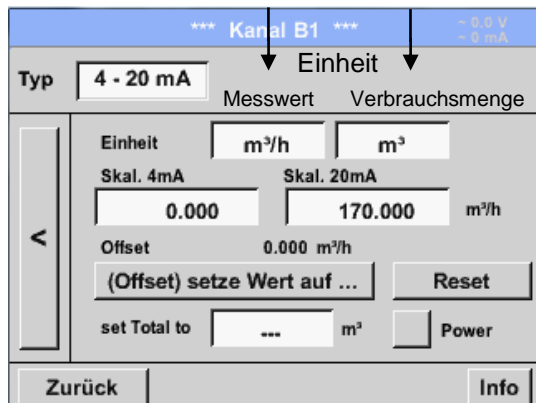

Selection of the units by pressing the respective unit, **Measured value** or **Consumption rate** text fields.

Enter scale values for 4 mA and 20 mA, here 0 m³/h and 170m³/h.

If required, it is possible to enter a start value for the consumption rate, for the takeover of a counter reading. For this, enter the value into the **Set total to** text field.

Confirmation of the entries by pressing the **OK** button.

Note:

The text field "unit-consumption rate" is only editable in case of measurement values (units) with volume or amounts per time unit and thus also the consumption calculation.

For the marking and setting of the text fields see also Chapter [7.3.2.1.2.7 Textfelder beschriften und einstellen](#)

15 Cleaning/decontamination



Note:

The METPOINT® BDL portable has a cleaning function which protects the display against unintentional operation in the event of cleaning measures. Please refer to Chapter 12.3.2.4.2 for further information.

Cleaning of the METPOINT® BDL portable must be undertaken using a slightly damp (not wet) cotton cloth or one-way wipe, and mild, commercially available cleaner/soap.

For decontamination, spray the cleaner on an unused cotton cloth or one-way wipe, and wipe the component comprehensively. Effectuate subsequent drying using a clean cloth or via air drying.

In addition, the local hygiene provisions need to be observed.



Warning!

Damage possible!

A too high degree of humidity and hard and pointed objects as well as aggressive cleaners cause damage to the data logger and to the integrated electronic components.

Measures

- Never clean with a soaked cloth.
- Do not use aggressive cleaners.
- Do not use pointed or hard objects for cleaning.

16 Dismantling and disposal

Disposal in accordance with the WEEE Directive (Waste Electrical and Electronic Equipment):

The waste of electrical and electronic components (WEE) must not be disposed of in the waste containers intended for city refuse or household waste. At the end of its usability, the product must be disposed of in an appropriate manner. Materials such as glass, plastic and some chemical compositions are, for the most part, recoverable, reusable, and can be reutilized.

According to the aforementioned directive, the METPOINT® BDL portable comes under category 9 and is, according to §5, Law 1 (the German ElektroG), not affected by the substance prohibition of marketing. According to §9, Law 7 (ElektroG), the METPOINT® BDL portable from BEKO TECHNOLOGIES GmbH is taken back to be disposed of.

If the BDL portable is not returned to BEKO TECHNOLOGIES GmbH for disposal, it must be disposed of in accordance with waste code:

20 01 36 Used electrical and electronic devices with the exception of those which come under 20 01 21, 20 01 23, and 20 01 35.



Batteries must not be disposed of with the residual waste. They need to be delivered to suitable recycling centers or collecting points.



Warning!

Danger for persons and the environment!

Old appliances must not be disposed of with normal household waste!

Depending on the used medium, residues on the device may represent a danger to the operator or the environment. Therefore, undertake suitable protective measures and dispose of the device properly.

Measures:

Immediately clean the removed components from media residues when suitable protective measures cannot be undertaken.

17 SD card and battery

For the storage and further processing of the recorded measuring results, there is an SD card slot inside the housing of the METPOINT® BDL portable.

An integrated battery (button cell) ensures the preservation of the configuration data even in the event of a voltage drop.



DANGER!

Battery and SD card!

The replacement of the battery or of the SD card must only be carried out by authorised and skilled personnel, and when the device is de-energized.



Danger!

Damage through ESD possible

The device contains electronic components which may be sensitive to electrostatic discharge (ESD) or that may even be damaged by ESD.

Measures

For any servicing measures that require an open housing, the instructions regarding the prevention of electrostatic discharge need to be observed.

18 Declaration of conformity

BEKO TECHNOLOGIES GMBH
 41468 Neuss, GERMANY
 Tel.: +49 2131 988-0
 www.beko-technologies.com



EC Declaration of Conformity

We hereby declare that the products indicated hereafter comply with the stipulations of the relevant directives and technical standards. This declaration only refers to products in the condition in which they have been placed into circulation. Parts which have not been installed by the manufacturer and/or modifications which have been implemented subsequently remain unconsidered.

| | |
|-----------------------------------|---|
| Product designation: | METPOINT® BDL portable |
| Type: | 4024289 |
| Supply voltage : | 100 ... 240 V AC / 12 V DC |
| IP degree of protection | IP 20 |
| Ambient temperature: | 0 ... + 50°C |
| Product description and function: | mobile hand-held measuring device for industrial applications |

Low-Voltage-Directive 2006/95/EC

| | |
|----------------------|-----------------|
| Standards applied: | EN 61010-1:2010 |
| Year of CE labelling | : 14 |

EMC Directive 2004/108/EC

| | |
|--------------------|-----------------|
| Standards applied: | EN 61326-1:2013 |
|--------------------|-----------------|

ROHS II Directive 2011/65/EU

The stipulations of the 2011/65/EU Directive on the restriction of the use of certain hazardous substances in electrical and electronic equipment are observed.

The products are labeled with the sign shown below:



Neuss, 6 October 2014

BEKO TECHNOLOGIES GMBH

p.p. Christian Riedel
 Head of Quality Department

19 Index

Danger compressed air 9
Danger supply voltage 6
Declaration of conformity 85
Field of application 7

Safety advice 6
Safety instructions 6
Skilled personnel 6
Technical data 10

| | | |
|---|--|--|
| <p>Headquarter :</p> <p>Deutschland / Germany BEKO TECHNOLOGIES GMBH Im Taubental 7 D-41468 Neuss Tel. +49 2131 988 0 beko@beko-technologies.com</p> | <p>中华人民共和国 / China BEKO TECHNOLOGIES (Shanghai) Co. Ltd. Rm.606 Tomson Commercial Building 710 Dongfang Rd. Pudong Shanghai China P.C. 200122 Tel. +86 21 508 158 85 Info.cn@beko-technologies.cn</p> | <p>France BEKO TECHNOLOGIES S.à.r.l. Zone Industrielle 1 rue des Frères Rémy F- 57200 Sarreguemines Tél. +33 387 283 800 info@beko-technologies.fr</p> |
| <p>India BEKO COMPRESSED AIR TECHNOLOGIES Pvt. Ltd. Plot No.43/1, CIEEP, Gandhi Nagar, Balanagar, Hyderabad - 500 037, INDIA Tel. +91 40 23080275 eric.purushotham@bekoindia.com</p> | <p>Italia / Italy BEKO TECHNOLOGIES S.r.l Via Peano 86/88 I - 10040 Leini (TO) Tel. +39 011 4500 576 info.it@beko-technologies.com</p> | <p>日本 / Japan BEKO TECHNOLOGIES K.K KEIHIN THINK 8 Floor 1-1 Minamiwatarida-machi Kawasaki-ku, Kawasaki-shi JP-210-0855 Tel. +81 44 328 76 01 info@beko-technologies.jp</p> |
| <p>Benelux BEKO TECHNOLOGIES B.V. Veenen 12 NL - 4703 RB Roosendaal Tel. +31 165 320 300 benelux@beko-technologies.com</p> | <p>Polska / Poland BEKO TECHNOLOGIES Sp. z o.o. ul. Chłapowskiego 47 PL-02-787 Warszawa Tel +48 22 855 30 95 info.pl@beko-technologies.pl</p> | <p>Scandinavia www.beko-technologies.com</p> |
| <p>España / Spain BEKO Tecnológica España S.L. Torruella i Urpina 37-42, nave 6 E-08758 Cervello Tel. +34 93 632 76 68 info.es@beko-technologies.es</p> | <p>South East Asia BEKO TECHNOLOGIES S.E.Asia (Thailand) Ltd. 75/323 Romkiao Road Sansab, Minburi Bangkok 10510 Thailand Tel. +66 2-918-2477 info.th@beko-technologies.com</p> | <p>臺灣 / Taiwan BEKO TECHNOLOGIES Co.,Ltd 16F.-5, No.79, Sec. 1, Xintai 5th Rd., Xizhi Dist., New Taipei City 221, Taiwan (R.O.C.) Tel. +886 2 8698 3998 Info.tw@beko-technologies.tw</p> |
| <p>Česká Republika / Czech Republic BEKO TECHNOLOGIES s.r.o. Na Pankraci 1062/58 CZ - 140 00 Praha 4 Tel. +420 24 14 14 717; 24 14 09 333 info@beko-technologies.cz</p> | <p>United Kingdom BEKO TECHNOLOGIES LTD. 2 West Court Buntsford Park Road Bromsgrove GB-Worcestershire B60 3DX Tel. +44 1527 575 778 info@beko-technologies.co.uk</p> | <p>USA BEKO TECHNOLOGIES CORP. 900 Great SW Parkway US - Atlanta, GA 30336 Tel. +1 404 924-6900 beko@bekousa.com</p> |

Original instructions in German.

Subject to technical changes / errors excepted.

metpoint_bdl_portable_manual_en-us_10-133_1501_v04.