

Installation and operating manual

Thermal flow meter

METPOINT® FLM SF13

FLMSF13LD8 | FLMSF13DD8 | FLMSF13LD15 | FLMSF13DD15 | FLMSF13LD20 | FLMSF13DD20 | FLMSF13LD25 |
FLMSF13DD25 | FLMSF13LD32 | FLMSF13DD32 | FLMSF13LD40 | FLMSF13DD40 | FLMSF13LD50 | FLMSF13DD50

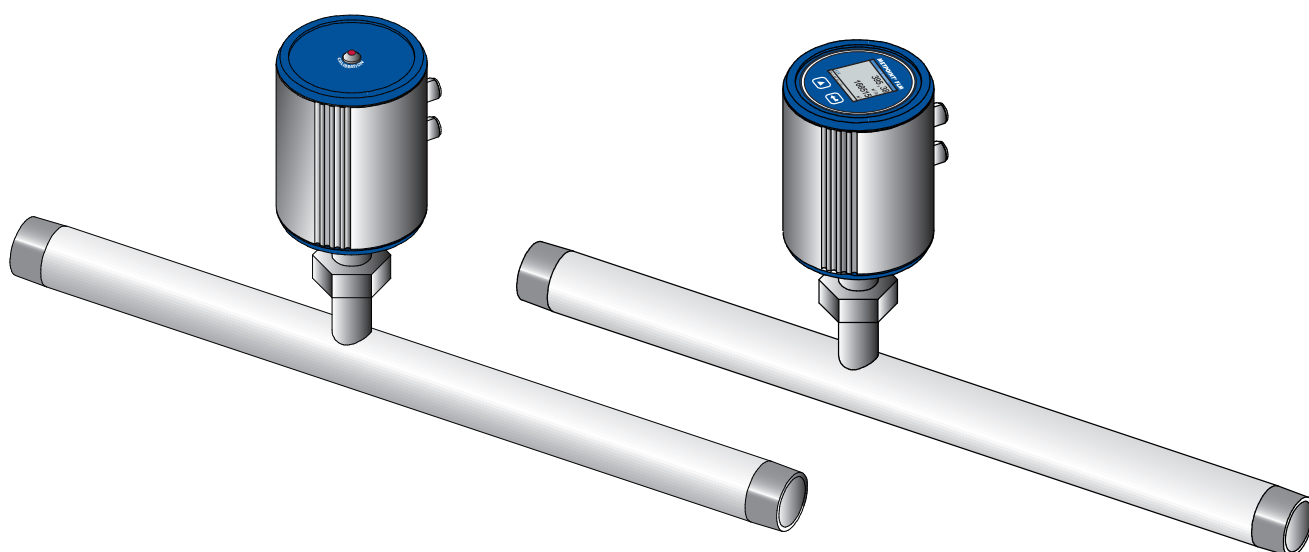

Content

1. Safety information	4
1.1. Pictograms and symbols	4
1.1.1. In this documentation.....	4
1.1.2. On the device.....	4
1.2. Signal words	4
1.3. Safety instructions	5
1.4. Transport and storage	6
1.5. Intended use	7
1.6. Warranty and liability	7
2. Product information	8
2.1. Scope of delivery	8
2.2. Type plate	8
2.3. Product overview and description	9
2.3.1. Identification based on product code.....	9
2.3.2. Product description.....	10
2.3.3. Operating principle.....	10
2.4. Control and display elements	11
2.4.1. Version with display.....	11
2.4.2. Version with LED.....	11
2.4.3. Direction of flow.....	12
2.5. Dimensions	13
2.6. Technical data	14
2.7. Measuring ranges	15
2.7.1. For air.....	15
2.7.2. For other gases.....	15
3. Installation	16
3.1. Warning	16
3.1.1. Requirements for piping.....	16
3.1.2. Requirements for inlet/outlet sections.....	16
3.1.3. Turning housing.....	17
4. Electrical installation	18
4.1. Pin assignment of plug-type connectors	18
4.2. Connection options	18
4.2.1. Bidirectional RS485 bus system.....	18
4.2.2. Current output 4 ... 20 mA, 3-wire.....	19
4.2.3. Mbus (optional).....	19
4.2.4. Galvanically isolated pulse output.....	20
4.3. Connection of METPOINT® BDL / BDL V2	20
4.3.1. Bidirectional RS485 bus system.....	20
4.3.2. Current output 4 ... 20 mA, 3-wire.....	21
4.3.3. Galvanically isolated pulse output.....	22
4.4. Connection to METPOINT® BDL compact	23
4.4.1. Bidirectional RS485 bus system.....	23
4.4.2. Current output 4 ... 20 mA, 3-wire.....	23
4.4.3. Galvanically isolated pulse output.....	24
4.5. Modbus termination	24
5. Start-up	25
6. Configuration and operation	25
6.1. Display during operation	25
6.2. Setup menu	26
6.3. Sensor Setup	26
6.3.1. Entering pipe inside diameter.....	27
6.3.2. Entering / changing consumption counter value.....	27
6.3.3. Selecting units for consumption, flow, temperature and pressure.....	28
6.3.4. Entering reference conditions.....	29
6.3.5. Setting zero point for low-flow cut-off function.....	30

6.4. ModBus setup	31
6.4.1. ModBus settings (2001 ... 2005).....	32
6.4.2. Values register (1001 ...1500).....	32
6.5. Pulse / alarm	33
6.5.1. Pulse output	33
6.6. User Setup	34
6.7. Advanced	34
6.8. 4 ... 20 mA	35
6.9. Info	36
6.10. MBus	36
6.10.1. Default communication settings.....	36
6.10.2. Transferred values.....	36
7. Spare parts and accessories	37
8. Maintenance and servicing	37
9. Cleaning sensor head	37
10. Calibration	37
11. LED indicator	37
12. Declaration of Conformity	38

1. Safety information

1.1. Pictograms and symbols

1.1.1. In this documentation



General instructions



Observe installation and operating instructions



General hazard symbol (danger, warning, caution)



General hazard symbol (danger, warning, caution) relating to mains voltage and powered machine parts

1.1.2. On the device



General instructions



General hazard symbol (danger, warning, caution)



Observe installation and operating instructions (on type plate)



1.2. Signal words

DANGER

Imminent danger

Consequences of non-compliance: serious or even fatal injury

WARNING

Potential danger

Consequences of non-compliance: serious or even fatal injury

CAUTION

Imminent danger



Consequences of non-compliance: injury and/or damage to property

NOTICE

Additional notes, tips and hints

Consequences of non-compliance: inefficient operation, extra maintenance; no risk to persons

1.3. Safety instructions

DANGER	Escaping compressed gas
	<p>Risk of serious or even fatal injury from contact with escaping compressed gas or from unsecured plant components.</p>
	<ul style="list-style-type: none"> • Before carrying out any assembly, installation or maintenance work, depressurize the system. All above work must be carried out by authorized specialist technical personnel¹. • Use only pressure-resistant installation materials and suitable tools that are in proper working order. • Before pressurizing the system, check all unit parts and repair them, if necessary. Open valves slowly to prevent pressure blows during operation. • Make sure that no persons can be injured or objects can be damaged by condensate or escaping compressed gas. • Protect the device parts against vibration and impact.
DANGER	Mains voltage
	<p>Risk of serious or even fatal injury from electric shock when coming into contact with non-insulated, powered components.</p>
	<ul style="list-style-type: none"> • For the electrical installation of the device, adhere to all applicable regulations (e.g. VDE 0100 / IEC 60364). • Before carrying out any maintenance work, de-energize the system. • All electrical work must be carried out by authorized specialist technical personnel¹. • The permissible operating voltage is printed on the type plate and must be strictly adhered to. • All components of the electrical installation on site must be approved and/or bear the CE mark. • A reliably accessible circuit breaker (e.g. power plug or switch) that shuts off all conductors must be installed close to the unit.
WARNING	Operation of device outside limit range
	<p>If the specified limits are exceeded, there is a risk of device malfunction, potentially resulting in injury and/or damage to property.</p>
	<ul style="list-style-type: none"> • The device must only be operated for the intended purpose and within the permissible limits specified on the type plate and in the technical data. • From 145 psi, install a high-pressure protection element for safe installation and removal of the device. • Do not operate the device in connection with flammable gases. • Strictly adhere to the prescribed operating times and maintenance intervals. • Observe the prescribed storage and transport conditions. • Prevent condensation on the sensor element. Ensure that the air fed through the device is free of droplets.

¹Specialist technical personnel

Specialist technical personnel are persons who, due to their professional qualification and knowledge in the field of measuring, control and pneumatic technology, and their knowledge of the applicable statutory regulations, guidelines and standards are in a position to foresee potential dangers in relation to the use of the device and are qualified to perform the tasks described in this manual. Special operating conditions (e.g. aggressive media) require additional knowledge.

1.4. Transport and storage

Despite our best efforts regarding packaging, etc., the device might be damaged during transport. Upon delivery, please remove all packaging material and inspect the device for visible damage. If you detect such damage, immediately notify the carrier company and BEKO TECHNOLOGIES Corporation or one of its agents.

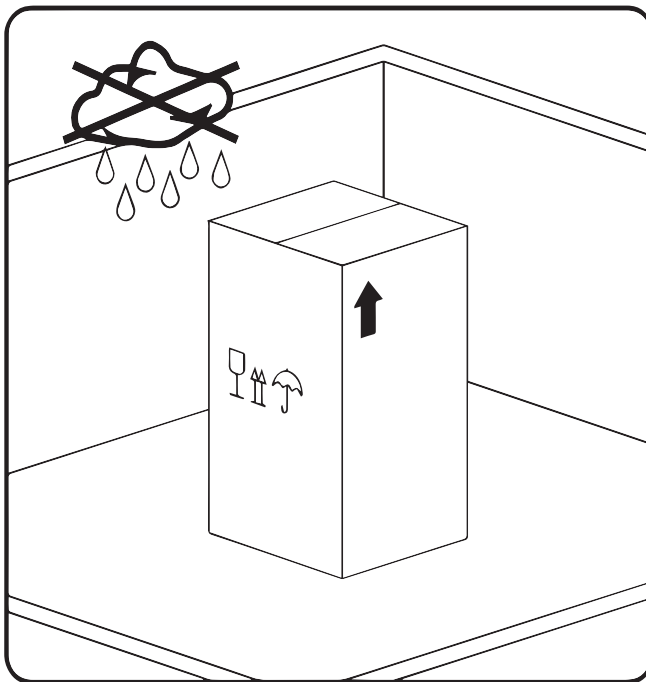

CAUTION	Damage caused during transport or storage
	<p>Incorrect transport or storage, or the use of unsuitable lifting equipment might cause damage to the device.</p> <ul style="list-style-type: none"> • The device must only be transported and stored by authorized and suitably trained technical personnel. • If you detect any damage, do not start the device. • Adhere to the permissible storage and transport temperatures (see technical data). • Protect the device against direct sunlight and heat radiation.



The device must be stored in the original packaging. Seal the packaging and store it in a dry and frost-free room. Ensure that the storage temperature does not exceed the limits specified on the type plate.

Even when packaged, take suitable measures to protect the device against the elements.

While in storage, secure the device so that it cannot topple over or fall, and protect it against vibration.

NOTICE	Recycling of packaging material
 	<ul style="list-style-type: none"> • The packaging material is recyclable. Dispose of the packaging material according to the applicable statutory regulations.

1.5. Intended use

The METPOINT® FLM is a thermal flow meter for the measurement of volume flow, consumption and flow velocity. By default, the device is configured for the measurement of volume flow in m³/h, consumption in m³ and velocity in m/s.

- The METPOINT® FLM is primarily used in compressed air systems. On request, the sensor can be programmed by BEKO TECHNOLOGIES Corporation for the measurement of other gases: nitrogen
- The device is not suitable for operation in potentially explosive or aggressive atmospheres.
- Protect the device against direct sunlight and heat radiation.

Operate the METPOINT® FLM only for the intended purpose and within the limit range specified in the technical data. Do not operate the device with any media (fluids, gas/vapor mixtures) other than those listed above. Any other use of the device is deemed improper and poses a risk to persons, property and the environment.

1.6. Warranty and liability

All warranty shall be voided, if the METPOINT® FLM is used improperly, for a purpose other than the intended or is operated outside the limits specified in the technical data. In such cases, the manufacturer shall also reject any liability for damages.



Improper operation includes:

- Incorrect installation, commissioning or operation; insufficient maintenance
- Operation with defective components
- Non-compliance with the instructions in this document, in particular the safety instructions
- Modification of the device
- Non-compliance with the prescribed maintenance intervals
- Use of third-party spare parts that have not been approved by the manufacturer

2. Product information

2.1. Scope of delivery

The table below shows the scope of delivery of the METPOINT® FLM.

Designation	Picture
Calibration certificate	
Connecting cable (5-wire)	

2.2. Type plate

The type plate is attached to the device housing. It contains all relevant technical data of the METPOINT® FLM. Please have these details to hand when contacting the manufacturer or supplier:

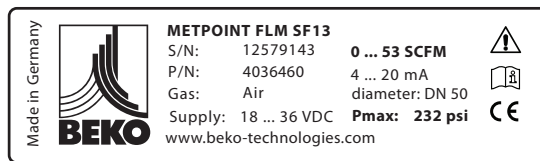

Designation	Description
METPOINT® FLM SF13	Type designation
S/N: 12579143	Serial number
P/N: 4036460	Product number
Gas: air	Medium
Supply: 18 ... 36 VDC	Power supply rating
0.1 ... 53 scfm	Min./max. measuring range
4 ... 20 mA	Min./max. current output
Diameter: DN50	Rated diameter of measuring section
Pmax: 232 psig	Max. permissible operating pressure

NOTICE	Handling of type plate
	Do not remove or cover the type plate, and protect it against damage. For more information regarding the symbols printed on the type plate, see 1.1 on page 4.

2.3. Product overview and description

2.3.1. Identification based on product code

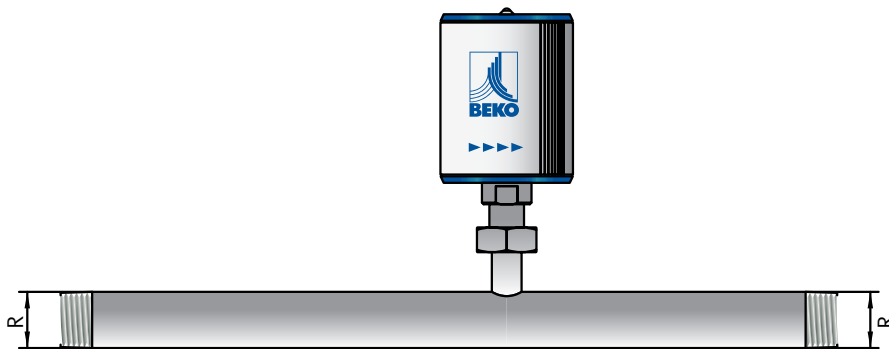
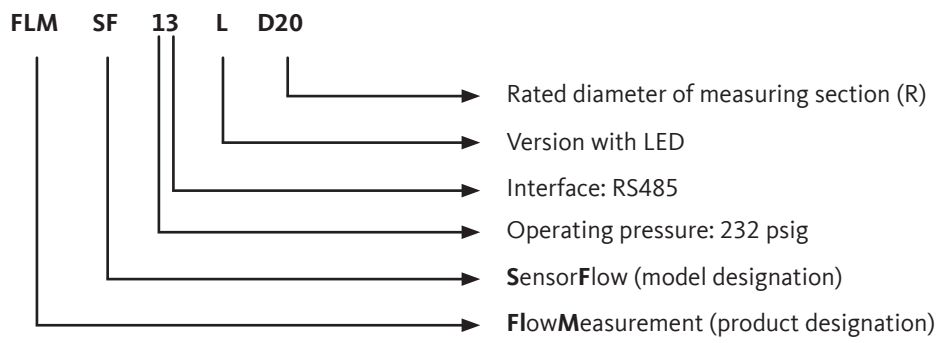

2.3.2. Product description

The METPOINT® FLM thermal flow meter measures the volume flow, which forms the basis for intelligent energy management. It can be used to identify potential savings, overloads and weak points in a system to improve its efficiency. By measuring the actual flow to the various production units, operators are in a position to make decisions based on facts. The METPOINT® FLM also indicates whether there are any leaks in their system. The METPOINT® FLM thus provides all the information operators need to correctly dimension and configure their system and system components for improved efficiency. The device is equipped with a Modbus RTU(RS485) interface, a 4 ... 20 mA current output, a galvanically isolated pulse output and an optional MBus interface.

2.3.3. Operating principle

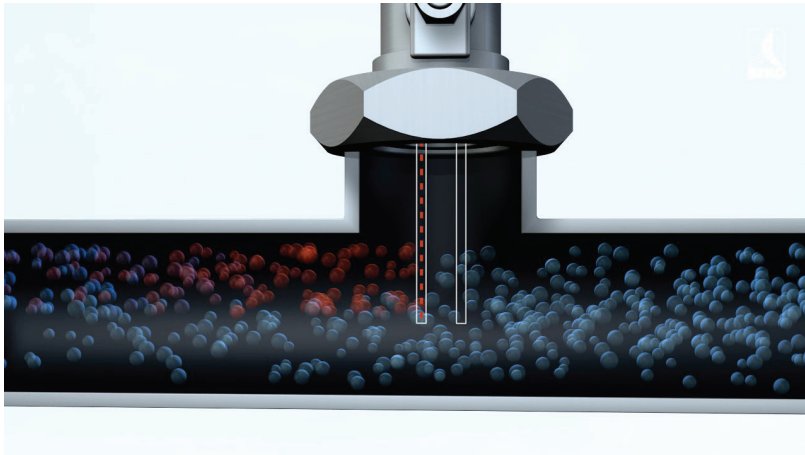



Two temperature sensors are installed in series in the direction of flow. The first temperature sensor measures the current process temperature, while the second sensor is electrically heated to a temperature that is exactly 40 K above the temperature measured by the first sensor. As the volume flow increases, the sensors would normally cool, but the electric heater of the second sensor prevents such a temperature drop.

The electric energy required to maintain the temperature difference is directly proportional to the volume flow. This energy consumption of the heater is converted into the relevant flow measurements. Taking into account the inside diameter of the pipe, the METPOINT® FLM determines the exact mass flow.

2.4. Control and display elements

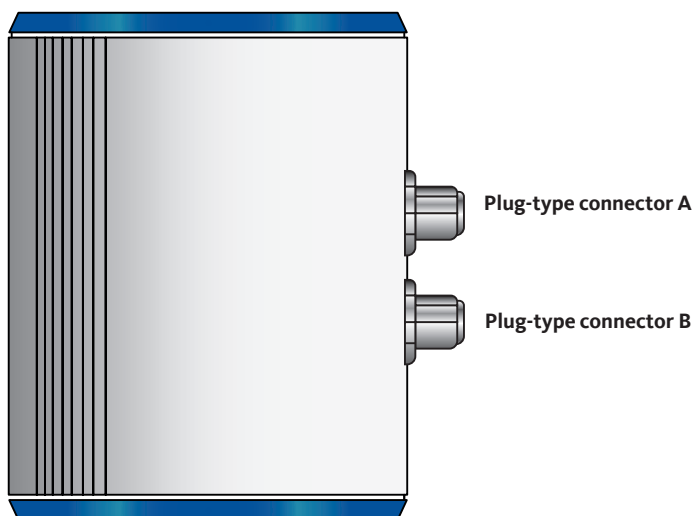
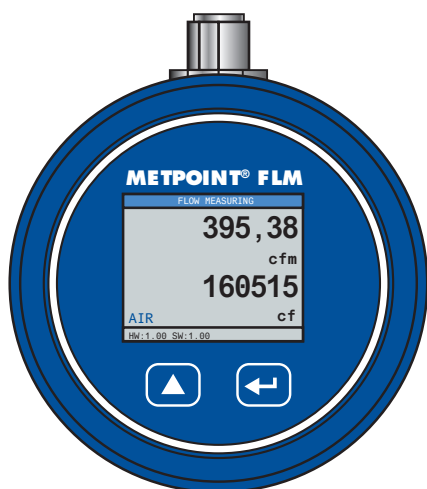
2.4.1. Version with display



NOTICE	Additional information
	For more information regarding the operation of the device, see „Configuration and operation“ on page 25.

2.4.2. Version with LED

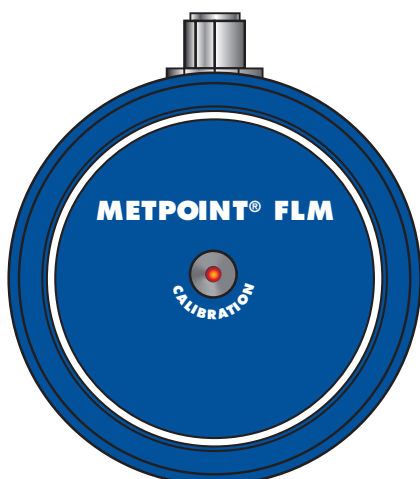



The METPOINT® FLM features a LED calibration indicator mounted at the top of the housing. After 15 months, the LED begins to flash, indicating that the device needs to be calibrated. The flashing LED does not have any effect on the measuring process, and the device continues to provide accurate measuring signals.

On request, the calibration interval can be adjusted at the factory.

2.4.3. Direction of flow

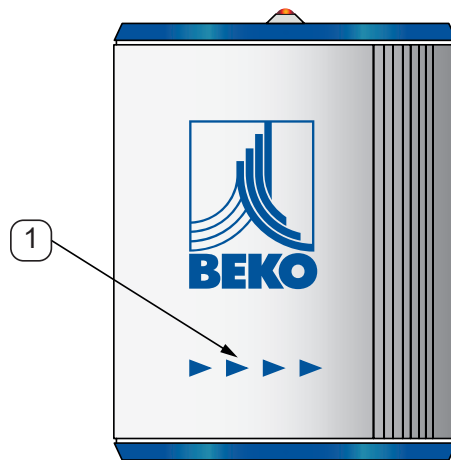
The direction of flow is indicated by the arrows (1) on the housing of the METPOINT® FLM and on the sensor tube.



NOTICE	Additional information
	If necessary, turn the housing (e.g. to change the direction of flow through the device). For more information, see „Turning housing“ on page 17.

2.5. Dimensions

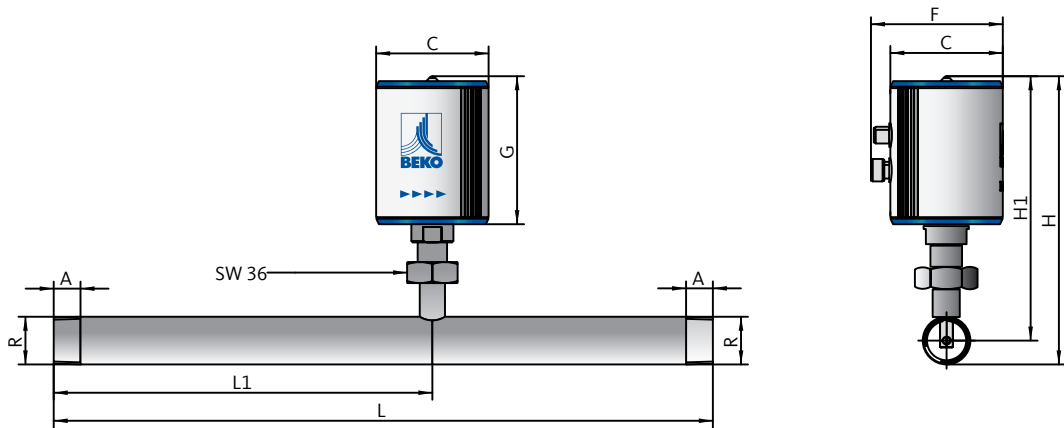
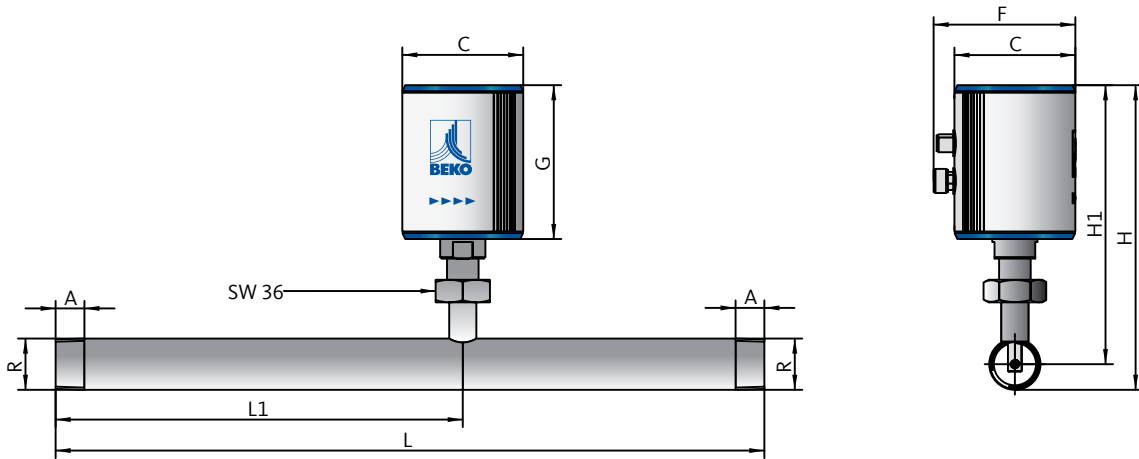

Dimensions		
	Version with display	Version with LED
A	G½" (ISO 228/1)	
C (inch)	3.14	
F (inch)	3.69	
G (inch)	4.01	4.15

Measuring section dimensions							
	DN8	DN15	DN20	DN25	DN32	DN40	DN50
R	NPT ¼"	NPT ½"	NPT ¾"	NPT 1"	NPT 1¼"	NPT 1½"	NPT 2"
H1 (inch)	7.34	7.34	7.34	7.34	7.34	7.34	7.34
H (inch)	7.61	7.76	78.69	8.00	8.17	8.29	8.52
L1 (inch)	5.38	8.25	10.81	10.81	10.81	10.81	10.81
L (inch)	7.62	11.79	18.67	18.67	18.67	18.67	18.67

2.6. Technical data

Technical data		
SF13		
Max. operating pressure	232 psig	
Measuring technique	Calorimetric	
Operating temperature	-30 ... +80 °C (-22 ... 176 °F)	
Measured parameters	m ³ /h (factory settings) On the display version, the following units can be chosen: m ³ /min, l/min, l/s, ft/min, cfm, m/s, kg/min, kg/s	
Sensor	Pt45, Pt1000	
Medium	compressed air, nitrogen	
Humidity of medium	max. 90 % rH (no droplets)	
Power supply	18 ... 36 VDC	
Power consumption	max. 5 W	
Digital output	RS485 (ModBus RTU)	
Current output	4 ... 20 mA (see table below) (max. resistance < 500 Ω)	
	Designation	Current output
	Measuring section DN8 (NPT ¼")	0.03 ... 3.2 cfm
	Measuring section DN15 (NPT ½")	0.12 ... 53 cfm
	Measuring section DN20 (NPT ¾")	0.18 ... 100 cfm
	Measuring section DN25 (NPT 1")	0.29 ... 170 cfm
	Measuring section DN32 (NPT 1¼")	0.41 ... 312 cfm
	Measuring section DN40 (NPT 1½")	0.59 ... 430 cfm
	Measuring section DN50 (NPT 2")	1.18 ... 703 cfm
Pulse output	Floating switch contact Passive: max. 48 VDC 150 mA 1 pulse per m ³ or per liter Unit adjustable at display	
Accuracy	± 1.5 % of measured value ± 0.3 % of final value	
Display/indicator	Display: TFT 1.8" (resolution: 220 x 167) or service LED	
Screw fitting	G½ (ISO 228/1)	
Material	Sensor tube and fittings: 1.4301 stainless steel Housing: Powder-coated aluminum Measuring section: 1.4404 (DIN EN 1092-1)	

Reference conditions according to DIN 1945 / ISO 1217

+20 °C (68 °F) and 1000 mbar; other reference values can be set through the display or service functions.

2.7. Measuring ranges

2.7.1. For air

Pipe size	Pipe inside \varnothing	Rated diameter	SF13	Consumption
Inch	Inch		Measuring range from ... to	Default settings
¼	0.33	DN8	0.03 ... 3.2 cfm	cfm
½	0.63	DN15	0.1 ... 53 cfm	
¾	0.85	DN20	0.2 ... 100 cfm	
1	1.07	DN25	0.3 ... 170 cfm	
1¼	1.45	DN32	0.4 ... 312 cfm	
1½	1.64	DN40	0.5 ... 430 cfm	
2	2.09	DN50	1.2 ... 703 cfm	

Reference standard DIN 1945 / ISO 1217 (20 °C (68 °F), 1000 mbar) and compressed air

2.7.2. For other gases

	¼"	½"	¾"	1"	1¼"	1½"	2"
	Current output 20 mA	Current output 20 mA	Current output 20 mA	Current output 20 mA	Current output 20 mA	Current output 20 mA	Current output 20 mA
	cfm						
Reference standard EN DIN ISO 1217: 20°C (68 °F), 1000 mbar (reference values for sensor calibration)							
Air	3.71	52.97	103	170.69	311.95	429.66	703.35
Adjustment for DIN 1343: 0 °C (32°F), 1000 mbar							
Air	3.53	47.09	94.17	158.92	285.46	394.35	647.44
Nitrogen	N₂	3.53	47.09	94.17	158.92	285.46	394.35

3. Installation

3.1. Warning

DANGER	Escaping compressed gas
	<p>Risk of serious or even fatal injury from contact with escaping compressed gas or from unsecured plant components.</p> <ul style="list-style-type: none"> • Before carrying out any assembly, installation or maintenance work, depressurize the system. Such work must be carried out by authorized specialist technical personnel only (see „Safety instructions“ on page 5). • From 145 psi, install a high-pressure protection element for safe installation and removal of the device. • Tighten the slotted spring pin with a torque of 177-265 inch lbs. • Use only pressure-resistant installation materials and suitable tools that are in proper working order. • Before pressurizing the system, check all unit parts and repair them, if necessary. Open valves slowly to prevent pressure blows during operation.

3.1.1. Requirements for piping

- Correctly dimensioned gaskets.
- Correctly installed and aligned flanges and gaskets.
- Differences in pipe diameters at joints should not exceed 0.0393 inch. For more information, see ISO 14511.
- Clean, properly installed pipes.

3.1.2. Requirements for inlet/outlet sections

The table below shows the required inlet pipe sections with reference to the direction of flow.

Table of additional inlet pipe sections required in specific cases

Flow obstruction <i>upstream</i> of measuring section	Minimum length of inlet pipe section (L1)	Minimum length of outlet pipe section (L-L1)
Slight bend (angle < 90°)	12 x D	5 x D
Reduction (pipe diameter becomes smaller towards measuring section)	15 x D	5 x D
Enlargement (pipe diameter becomes larger towards measuring section)	15 x D	5 x D
90° elbow section or T-piece	15 x D	5 x D
2x 90° elbow sections in a plane	20 x D	5 x D
2x 90° elbow sections change of direction in 3 dimensions	35 x D	5 x D
Shut-off valve	45 x D	5 x D

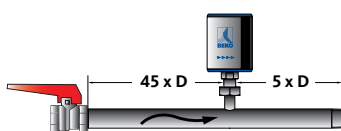
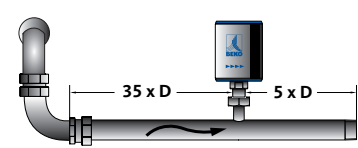
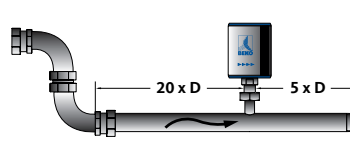
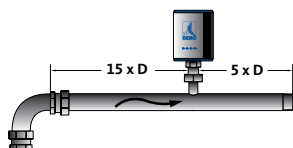
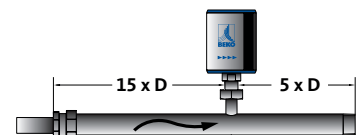
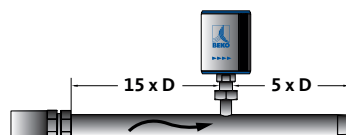
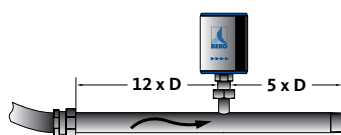

NOTICE	Deviating measurements
	The above values are required minimum values. If the recommended settling sections cannot be implemented, the measuring deviations might be much greater.

3.1.3. Turning housing

If required by the flow direction, the housing can be turned by 180° by loosening the 4 setscrews with 1.5mm hexagon sockets. Align the housing as required and tighten the setscrews again by hand.

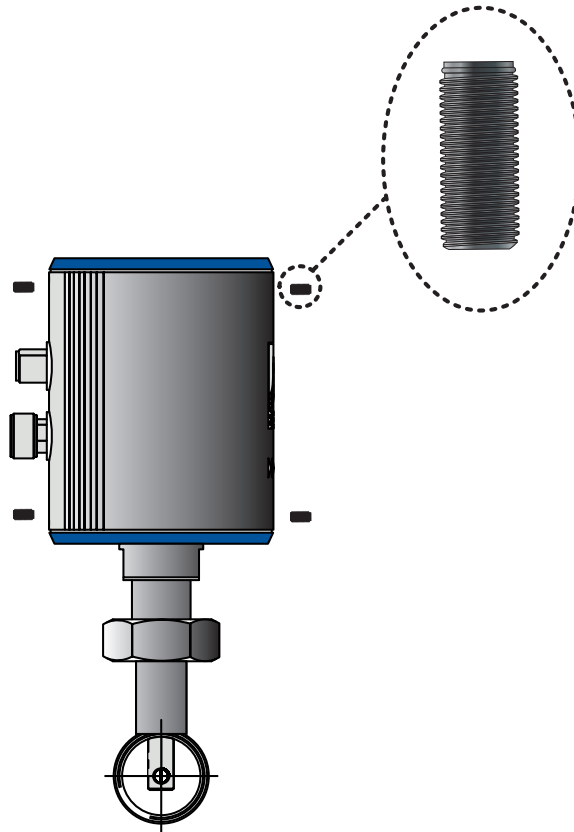

NOTICE	Risk of damage to device
	Ensure that the connecting pipes are correctly mounted and that the gaskets are installed properly.

4. Electrical installation

4.1. Pin assignment of plug-type connectors

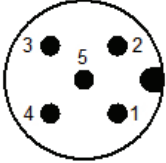
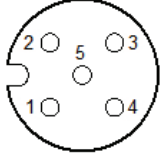
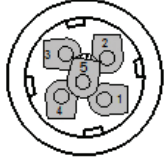
Pin assignment of plug-type connector A, M12 x 1, 5-pin, A-coded (according to EN 61076-2-101)		
Pin assignment of connector Transmitter side	Pin assignment of connector Socket side	Pin assignment of connector Screw side
		

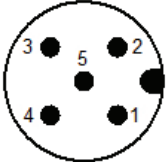
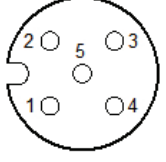
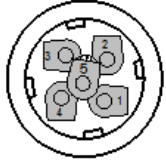
Pin assignment of plug-type connector B, M12 x 1, 5-pin, A-coded (according to EN 61076-2-101)		
Pin assignment of connector Transmitter side	Pin assignment of connector Socket side	Pin assignment of connector Screw side
		

4.2. Connection options

4.2.1. Bidirectional RS485 bus system

Connection by means of plug-type connector A.

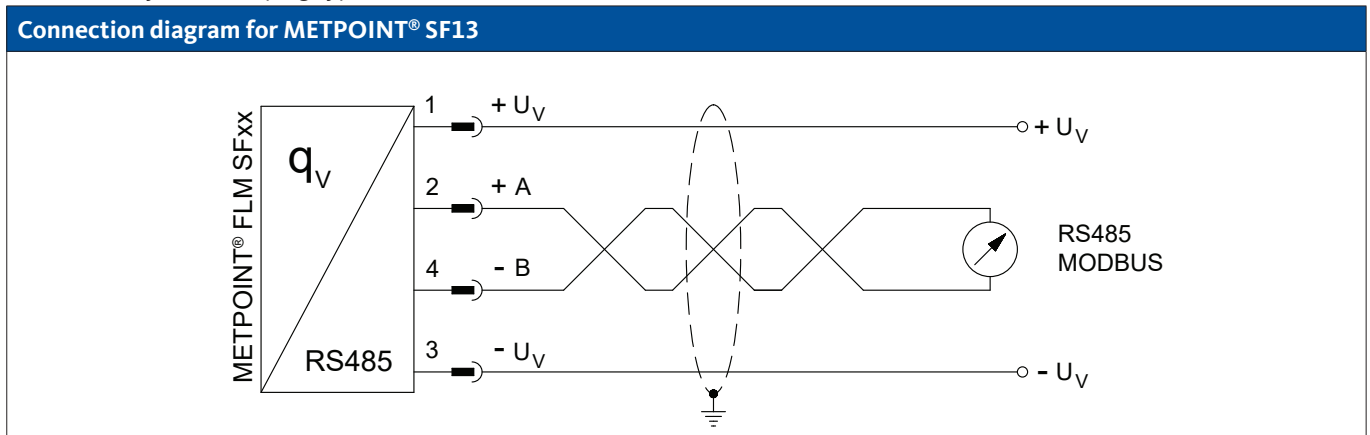

Pin assignment - sensor		Function	Wire color
PIN-1	+ U _v	Plus (+) connection, power supply	brown
PIN-2	Bus A (+)	Non-inverted signal (+) from RS485 interface	white
PIN-3	- U _v	Minus (-) connection, power supply	blue
PIN-4	Bus B (-)	Inverted signal (-) from RS485 interface	black
PIN-5		not assigned	grey

4.2.2. Current output 4 ... 20 mA, 3-wire

Connection by means of plug-type connector A.

Connection diagram for METPOINT® SF13

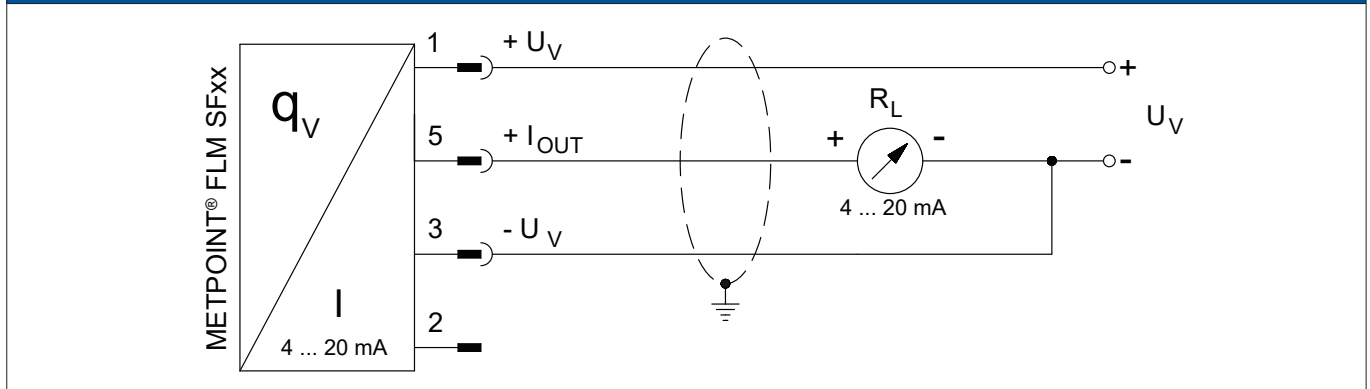

Pin assignment - sensor		Function	Wire color
PIN-1	+ U _v	Plus (+) connection, power supply	brown
PIN-2		not assigned	white
PIN-3	- U _v	Minus (-) connection, power supply	blue
PIN-4		not assigned	black
PIN-5	+ I _{OUT}	Current output	grey

4.2.3. Mbus (optional)

Connection by means of plug-type connector B.

Connection diagram for METPOINT® SF13

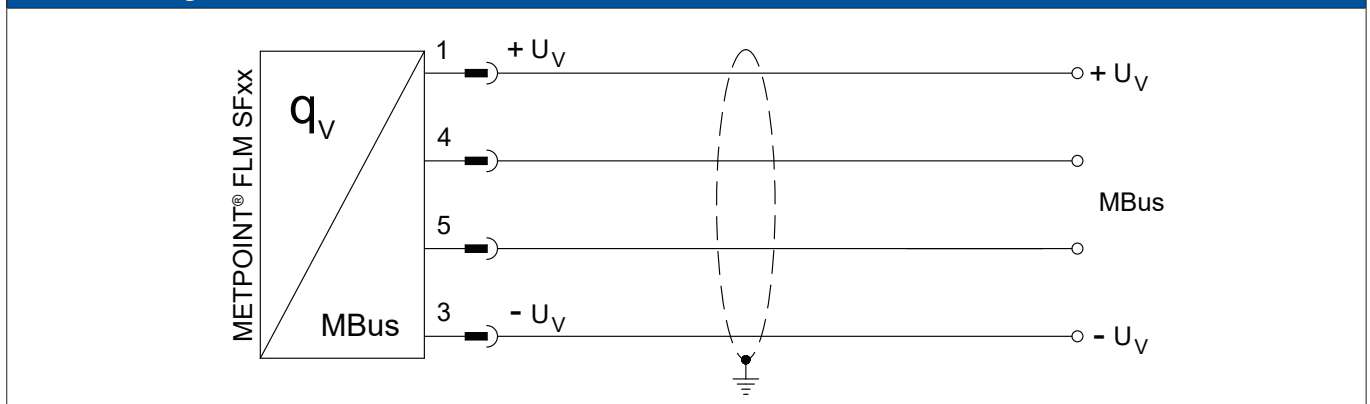

Pin assignment - sensor		Function	Wire color
PIN-1		not assigned	brown
PIN-2		not assigned	white
PIN-3		not assigned	blue
PIN-4	Mbus	Mbus	black
PIN-5	Mbus	Mbus	grey

4.2.4. Galvanically isolated pulse output

Connection by means of plug-type connector B.

Connection diagram for METPOINT® SF13

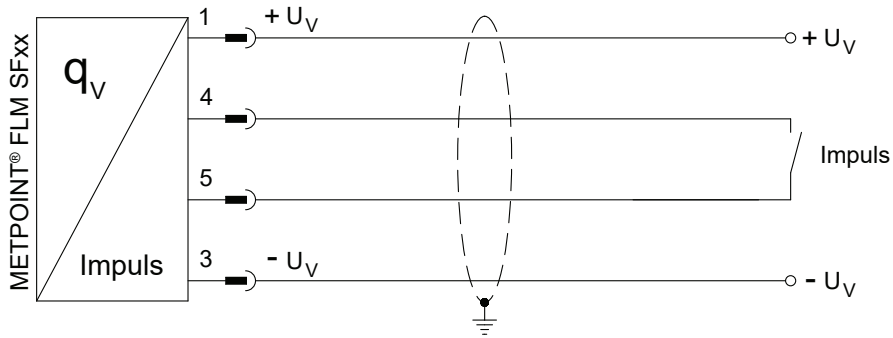

Pin assignment - sensor		Function	Wire color
PIN-1		not assigned	brown
PIN-2		not assigned	white
PIN-3		not assigned	blue
PIN-4	Pulse	Galvanically isolated pulse	black
PIN-5	Pulse	Galvanically isolated pulse	grey

4.3. Connection of METPOINT® BDL / BDL V2

4.3.1. Bidirectional RS485 bus system

Connection by means of plug-type connector A.

Connection diagram for METPOINT® SF13 and METPOINT® BDL / BDL V2

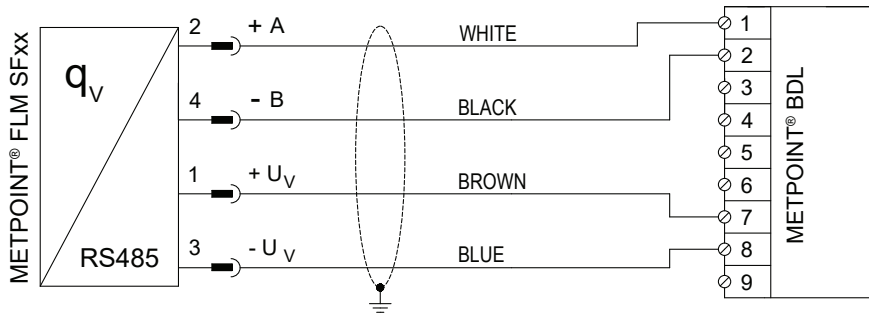

Pin assignment - sensor		Function	Wire color	Pin assignment - BDL	
PIN-1	+ U _v	Plus (+) connection, power supply	brown	PIN-7	+ U _v
PIN-2	Bus A (+)	Non-inverted signal (+) from RS485 interface	white	PIN-1	(+) A / RS485
PIN-4	Bus B (-)	Inverted signal (-) from RS485 interface	black	PIN-2	(-) B / RS485
PIN-3	- U _v	Minus (-) connection, power supply	blue	PIN-8	- U _v

4.3.2. Current output 4 ... 20 mA, 3-wire

Connection by means of plug-type connector A.

Connection diagram for METPOINT® SF13 and METPOINT® BDL

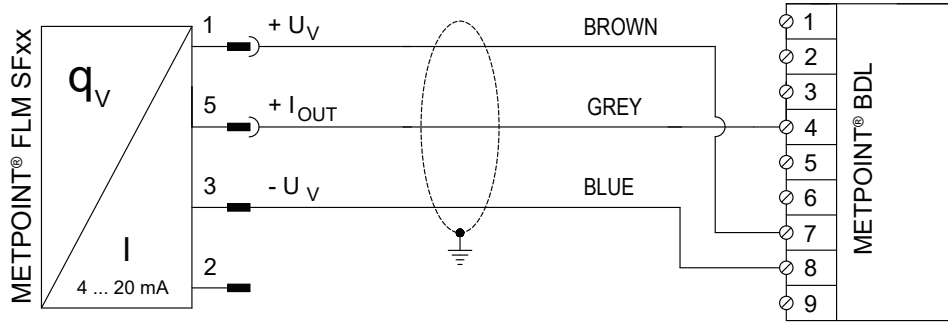

Pin assignment - sensor		Function	Wire color	Pin assignment - BDL	
PIN-1	+ U _v	Plus (+) connection, power supply	brown	PIN-7	+ U _v
PIN-5	+ I _{OUT}	Current output	grey	PIN-4	Analog IN (+)
PIN-3	- U _v	Minus (-) connection, power supply	blue	PIN-8	- U _v
PIN-2		not assigned	white		
PIN-4		not assigned	black		

Connection by means of plug-type connector A.

Connection diagram for METPOINT® SF13 and METPOINT® BDL V2

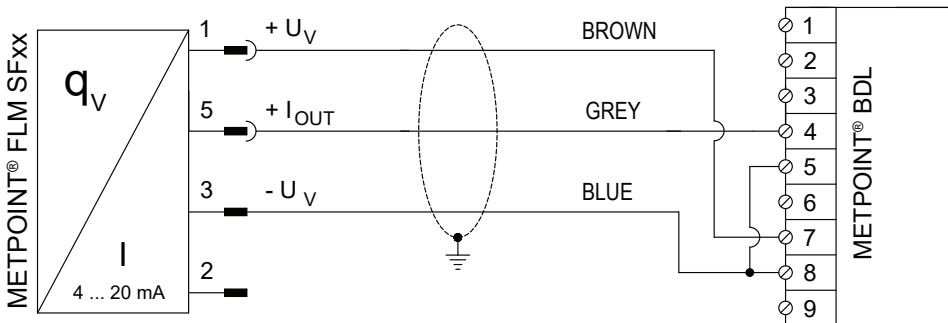

Pin assignment - sensor		Function	Wire color	Pin assignment - BDL	
PIN-1	+ U _v	Plus (+) connection, power supply	brown	PIN-7	+ U _v
PIN-5	+ I _{OUT}	Current output	grey	PIN-4	Analog IN (+)
PIN-3	- U _v	Minus (-) connection, power supply	blue	PIN-8	- U _v
PIN-2		not assigned	white		
PIN-4		not assigned	black		

4.3.3. Galvanically isolated pulse output

Connection by means of plug-type connector B.

Connection diagram for METPOINT® SF13 and METPOINT® BDL / BDL V2

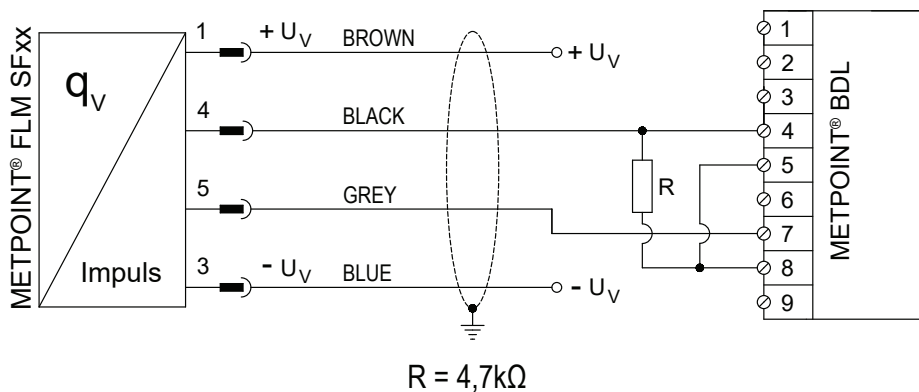

Pin assignment - sensor		Function	Wire color	Pin assignment - BDL	
PIN-1	+ U _v	not assigned	brown		
PIN-4	Pulse	Pulse	black	PIN-4	Analog IN (+)
PIN-5	Pulse	Pulse	grey	PIN-7	+ U _v
PIN-3	- U _v	not assigned	blue		
PIN-2		not assigned	white		

4.4. Connection to METPOINT® BDL compact

4.4.1. Bidirectional RS485 bus system

Connection by means of plug-type connector A.

Connection diagram for METPOINT® SF13 and METPOINT® BDL compact (digital board)

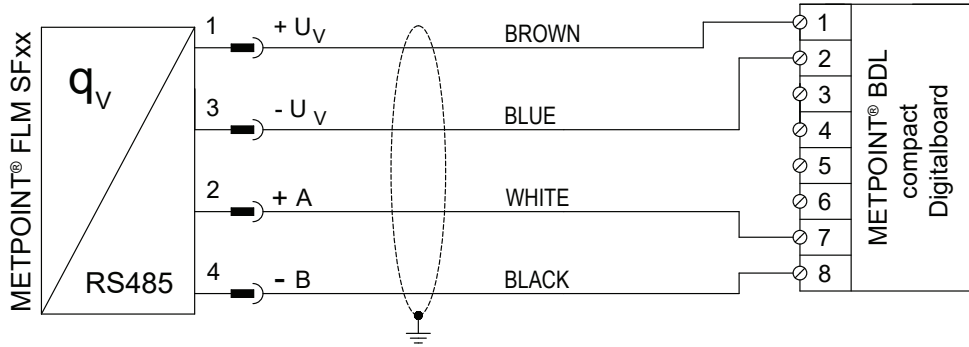

Pin assignment - sensor		Function	Wire color	Pin assignment - BDL compact	
PIN-1	+ U _v	Plus (+) connection, power supply	brown	PIN-1	+ U _v
PIN-3	- U _v	Minus (-) connection, power supply	blue	PIN-2	- U _v
PIN-2	+ A	Non-inverted signal (+) from RS485 interface	white	PIN-7	(+) RS485 (A)
PIN-4	- B	Inverted signal (-) from RS485 interface	black	PIN-8	(-) RS485 (B)
PIN-5		not assigned	grey		

4.4.2. Current output 4 ... 20 mA, 3-wire

Connection by means of plug-type connector A.

Connection diagram for METPOINT® SF13 and METPOINT® BDL compact (analog board)

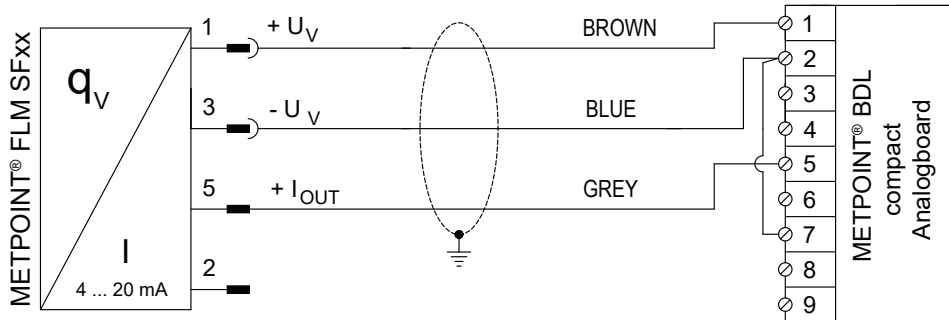

Pin assignment - sensor		Function	Wire color	Pin assignment - BDL compact	
PIN-1	+ U _v	Plus (+) connection, power supply	brown	PIN-1	+ U _v
PIN-3	- U _v	Minus (-) connection, power supply	blue	PIN-2	- U _v
PIN-5	+ I _{OUT}	Current output	grey	PIN-5	(+) I
PIN-2		not assigned	white		
PIN-4		not assigned	black		

4.4.3. Galvanically isolated pulse output

Connection by means of plug-type connector B.

Connection diagram for METPOINT® SF13 and METPOINT® BDL compact (analog board)

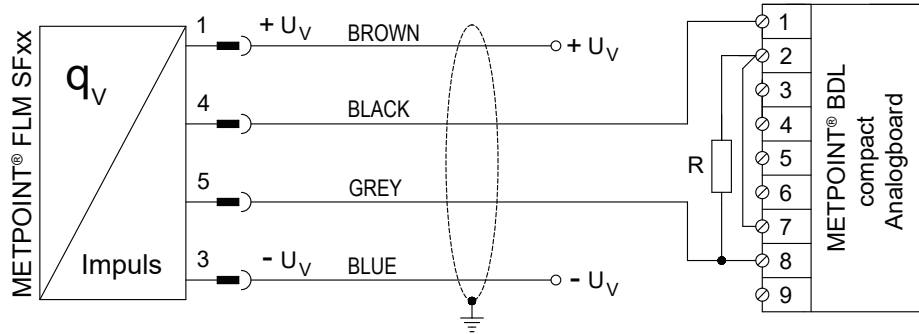

Pin assignment - sensor		Function	Wire color	Pin assignment - BDL compact	
PIN-1	+ U _v	not assigned	brown		
PIN-4	Pulse	Pulse	black	PIN-1	+ U _v
PIN-5	Pulse	Pulse	grey	PIN-8	(+) V - PT
PIN-3	- U _v	not assigned	blue		
PIN-2		not assigned	white		

4.5. Modbus termination

If the METPOINT® FLM is the last device in the Modbus system, it must be terminated. The sensor is equipped with a built-in terminator. To terminate the device, loosen the 2 top setscrews at the housing. lift off the lid and set the DIP switch (1) to ON. When closing the sensor housing, ensure that the housing gasket is correctly installed.

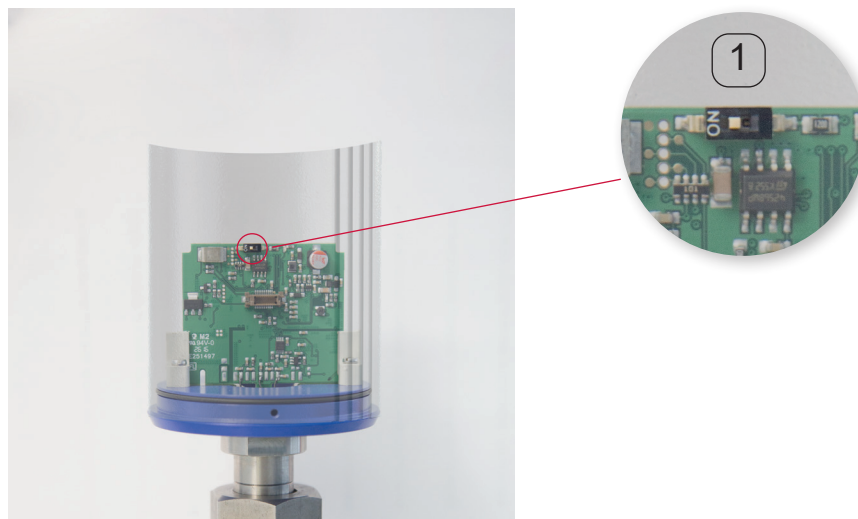

5. Start-up

To start the METPOINT® FLM, power it and perform the sensor setup as described in „Sensor Setup“ on page 26. Slowly pressurize the pipes.

6. Configuration and operation

When the METPOINT® FLM is powered, it is automatically initialized. After this step is completed, the main menu is displayed.



The device menus are operated through two capacitive buttons:



>>UP<<



>>ENTER<<

6.1. Display during operation

type of gas / status message → Air

HW-Version SW-Version Modbus ID page no.

CAL indicates that calibration is due:

After 15 months, message **CAL** is displayed, indicating that the device needs to be calibrated. This message does not have any effect on the measuring process, and the device continues to provide accurate measuring signals. On request, the calibration interval can be adjusted at the factory.

Press the >>UP<< button to call up pages 2 - 5.

6.2. Setup menu

Press the >>ENTER<< button to call up the setup menu.
The setup menu is password-protected.



Default password (factory settings): 0000 (4 x zero).

If required, change the password by selecting **Setup**→**User Setup**→**Password** .

Press the >>UP<< button to select and to change a value.



Press the >>ENTER<< button to confirm the selection or change.

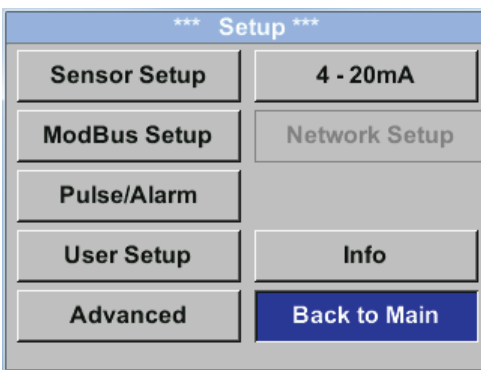

6.3. Sensor Setup

Setup → **Sensor Setup**

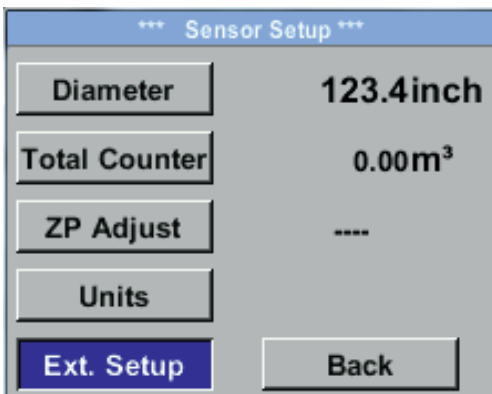

To make a change, select the respective menu option using the >>UP<< button and confirm by pressing the >>ENTER<< button.

6.3.1. Entering pipe inside diameter

Setup → Sensor Setup → Diameter

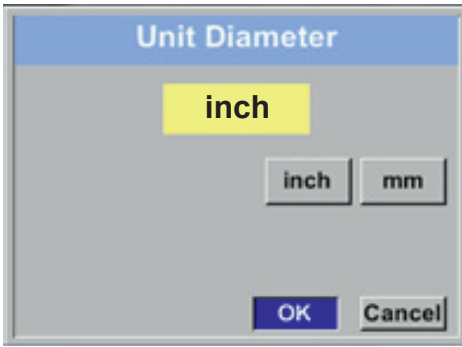

To change the unit, press the >>UP<< button to select the "Unit" field and confirm by pressing the >>ENTER<< button.

Press the >>UP<< button to select the desired unit and confirm by pressing the >>ENTER<< button 2x.

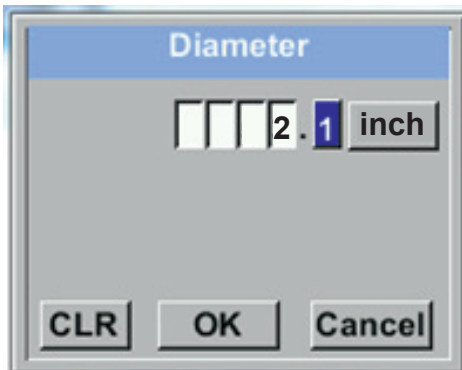

Press the >>UP<< button to select the value to be changed and confirm by pressing the >>ENTER<< button.

Press the >>UP<< button to enter the new value and confirm by pressing the >>ENTER<< button.

6.3.2. Entering / changing consumption counter value

Setup → Sensor Setup → Total Counter

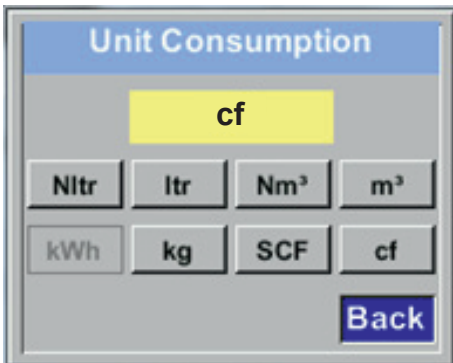

To change the unit, press the >>UP<< button to select the "Unit" field and confirm by pressing the >>ENTER<< button.

Press the >>UP<< button to select the desired unit and confirm by pressing the >>ENTER<< button 2x.

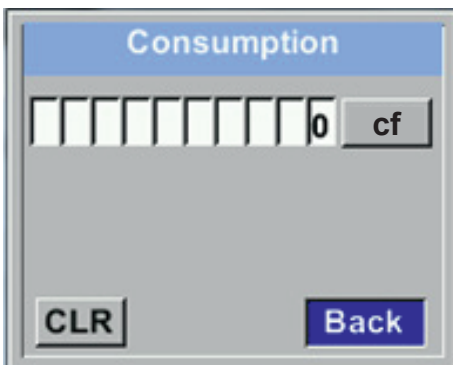

Press the >>UP<< button to select the value to be changed and confirm by pressing the >>ENTER<< button.

Press the >>UP<< button to enter the new value and confirm by pressing the >>ENTER<< button.

NOTICE	Consumption counter value
	When the consumption counter reaches 1,000,000,000 cf, it is automatically reset to 0.

6.3.3. Selecting units for consumption, flow, temperature and pressure

Setup → Sensor Setup → Units

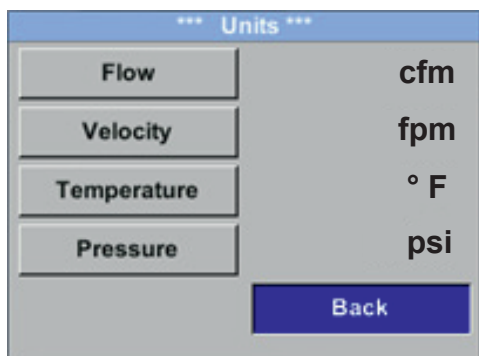

To change the unit, press the >>UP<< button to select the "Unit" field and confirm by pressing the >>ENTER<< button.

If there are more possible units that fit on the screen, press the "<<" button to call up the next screen.

Press the >>UP<< button to select the desired unit and confirm by pressing the >>ENTER<< button 2x.

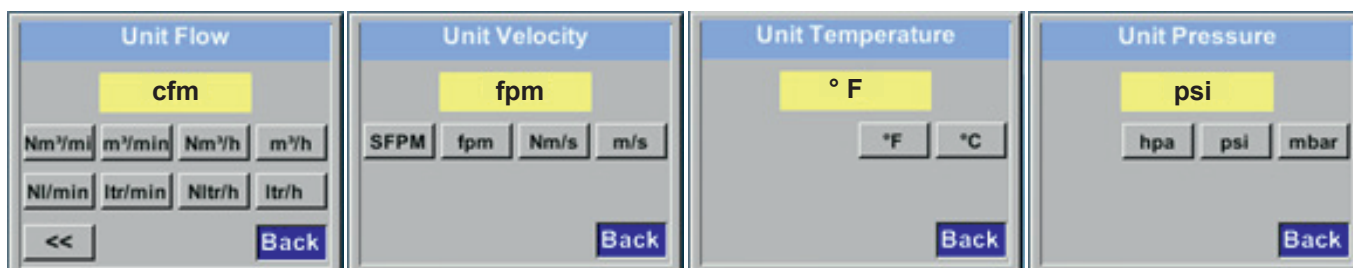

6.3.4. Entering reference conditions

Setup → Sensor Setup → Ext. Setup

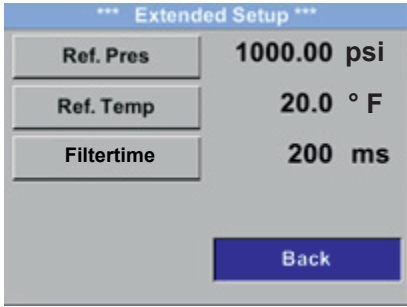

Enter the reference parameter values.

Setup → Sensor Setup → Ext. Setup → Ref. Pres

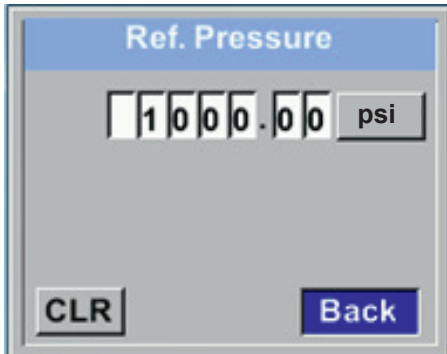

To change the reference pressure, press the >>UP<< button to select the "Unit" field and confirm by pressing the >>ENTER<< button.

Press the >>UP<< button to select the desired unit and confirm by pressing the >>ENTER<< button 2x.

Setup → Sensor Setup → Ext. Setup → Ref. Temp

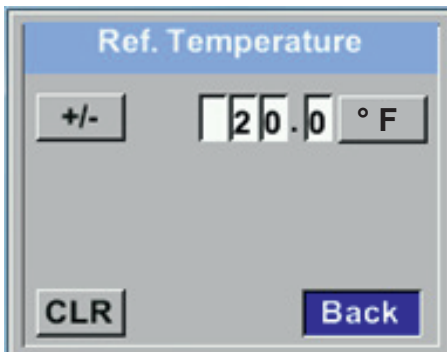

Enter the reference temperature.

Setup → Sensor Setup → Ext. Setup → Filtertime



Under "Filtertime", you can enter an attenuation, provided that a "Filtergrade" is entered.
Possible values: 0 -10000 in [ms].

6.3.5. Setting zero point for low-flow cut-off function

Setup → Sensor Setup → ZP Adjust

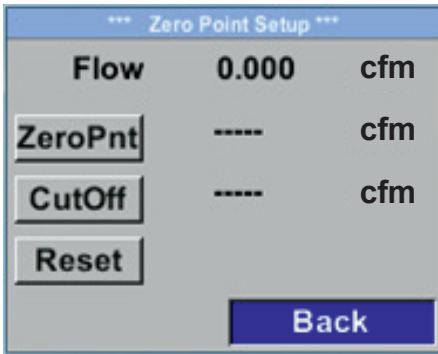

Enter the zero point and the low-flow cut-off point.

Setup → Sensor Setup → ZP Adjust → ZeroPnt

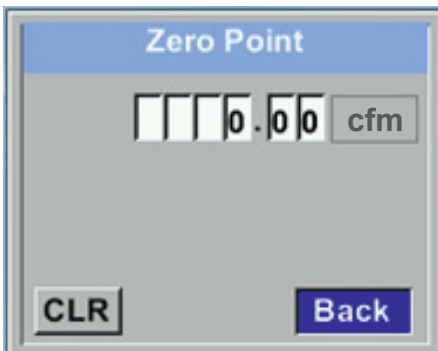

If the installed sensor shows a flow rate of > 0 cfm even if there is no flow, you can enter a zero point for the characteristic.

To delete the cut-off point, press the "CLR" button.
To return to the previous screen, press the "Back" button.

Setup → Sensor Setup → ZP Adjust → CutOff



The low-flow cut-off function is used to set consumption rates below the entered low-flow cut-off point to 0 cfm so that they do not cause the consumption counter value to increase.

To delete the cut-off point, press the "CLR" button.
To return to the previous screen, press the "Back" button.

Setup → Sensor Setup → ZP Adjust → Reset

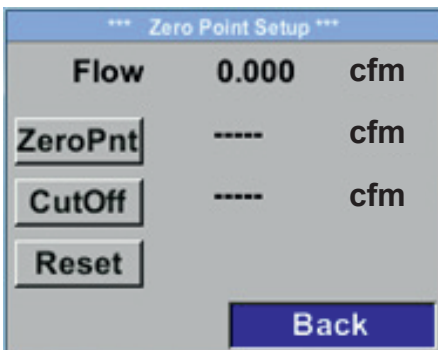

To reset the entered zero point or the low-flow cut-off point, press the "Reset" button.

To return to the previous screen, press the "Back" button.

6.4. ModBus setup

The METPOINT® FLM thermal flow meter is equipped with a RS485 interface (ModBus RTU). Before starting the sensor, configure the communication parameters

- ModBus ID, baud rate, parity and stop bit

to enable communication with the ModBus master.

Setup → ModBus Setup

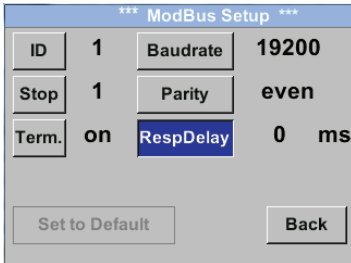

Save the settings by pressing the "Save" button. To apply the default (factory) settings, press the "Set to Default" button.

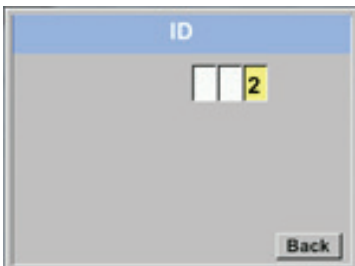

ModBus default settings:
ModBus ID: 1
Baud rate: 19200
Stop bit: 1
Parity: even

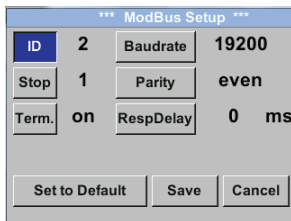

Caution:

If the sensor is the last device in the Modbus system, it must be terminated. The sensors are equipped with a built-in terminator. To activate termination, loosen the 2 setscrews of the housing, remove the lid and set the DIP switch to "On". When closing the sensor housing, ensure that the housing gasket is correctly installed.

6.4.1. ModBus settings (2001 ... 2005)

ModBus register	Register address	Byte	Data type	Description	Default	Read/write	Unit/comment
2001	2000	2	UInt16	ModBus ID	1	R/W	ModBus ID 1...247
2002	2001	2	UInt16	Baud rate	4	R/W	0 = 1200 1 = 2400 2 = 4800 3 = 9600 4 = 19200 5 = 38400
2003	2002	2	UInt16	Parity	1	R/W	0 = none 1 = even 2 = odd
2004	2003	2	UInt16	Number of stop bits		R/W	0 = 1 stop bits 1 = 2 stop bits
2005	2004	2	UInt16	Word order	0xABCD	R/W	0xABCD = big endian 0xCDAB = middle endian

6.4.2. Values register (1001 ...1500)

Modbus Register	Register Adresse	No. of Byte	Data Type	Description	Default	Read/Write	Holding Register
1101	1100	4	Float	Flow in m ³ /h		R	X
1109	1108	4	Float	Flow in Nm ³ /h		R	X
1117	1116	4	Float	Flow in m ³ /min		R	X
1125	1124	4	Float	Flow in Nm ³ /min		R	X
1133	1132	4	Float	Flow in ltr/h		R	X
1141	1140	4	Float	Flow in Nltr/h		R	X
1149	1148	4	Float	Flow in ltr/min		R	X
1157	1156	4	Float	Flow in Nltr/min		R	X
1165	1164	4	Float	Flow in ltr/s		R	X
1173	1172	4	Float	Flow in Nltr/s		R	X
1181	1180	4	Float	Flow in cfm		R	X
1189	1188	4	Float	Flow in Ncfm		R	X
1197	1196	4	Float	Flow in kg/h		R	X
1205	1204	4	Float	Flow in kg/min		R	X
1213	1212	4	Float	Flow in kg/s		R	X
1221	1220	4	Float	Flow in kW		R	X
1269	1268	4	UInt32	Consumption m ³ before comma	X	R	X
1275	1274	4	UInt32	Consumption Nm ³ before comma	X	R	X
1281	1280	4	UInt32	Consumption ltr before comma	X	R	X
1287	1286	4	UInt32	Consumption Nltr before comma	X	R	X
1293	1292	4	UInt32	Consumption cf before comma	X	R	X
1299	1298	4	UInt32	Consumption Ncf before comma	X	R	X
1305	1304	4	UInt32	Consumption kg before comma	X	R	X
1311	1310	4	UInt32	Consumption kWh before comma	X	R	X
1347	1346	4	Float	Velocity m/s		R	X
1355	1354	4	Float	Velocity Nm/s		R	X
1363	1362	4	Float	Velocity Ft/min		R	X
1371	1370	4	Float	Velocity NFt/min		R	X
1419	1418	4	Float	GasTemp °C		R	X
1427	1426	4	Float	GasTemp °F		R	X

6.5. Pulse / alarm

Setup → Pulse/Alarm

The galvanically isolated pulse output can be used as a pulse or as an alarm output.

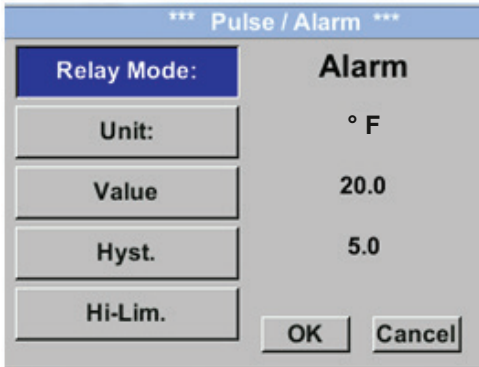

The following units can be selected for the alarm output:

- kg/min, cfm, l/s, m³/h, m/s, °F, °C, kg/s

Press "Value" to enter the alarm value. Press "Hyst." to enter the desired hysteresis.

Hi-Lim: upper limit
Lo-Lim: lower limit

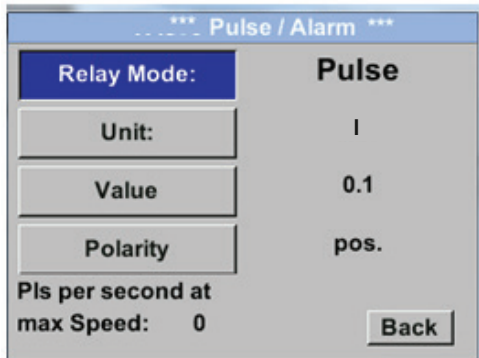

The following units can be selected for pulse output:

- kg, cd, l, m³

Select "Value" to enter the pulse factor (0.1, 1, 10, 100). Select "Polarity" to enter the switching state (plus = 0 → 1, minus = 1 → 0).

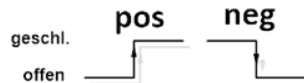

6.5.1. Pulse output

The maximum permissible number of pulses per second is 50. Pulse output is delayed by 1 second.

Pulse factor	cfm [ft³/min]
0.02642 gal / pulse	10.59
0.2642 / pulse	105.94
3.5315 ft³ / pulse	10594.40
35,3147 ft³ / pulse	105944.00

Table 1: Maximum flow volumes for pulse output

NOTICE	Important information
	Pulse factors that are unsuitable to represent the measuring range limit value are not permissible. Such entries are discarded and an error message is displayed.

6.6. User Setup

Setup → User Setup

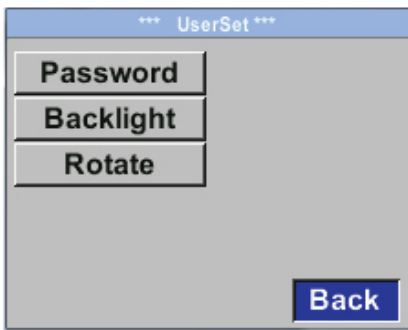

On the user setup screen, you can change the password, rotate the display and adjust its brightness.

- Password = change password
- Backlight = adjust brightness
- Rotate = rotate display



To change the password, you must enter the new password twice. The password must consist of 4 numerical digits.

6.7. Advanced

Setup → Advanced

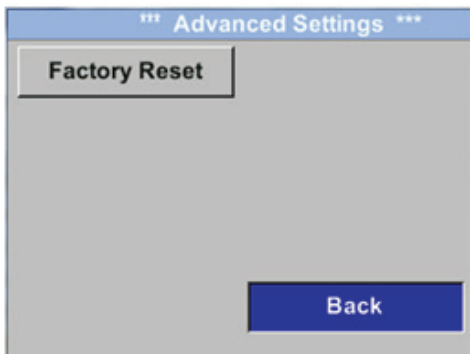

Press the "Factory Reset" button to reset the METPOINT® FLM to its default (factory) settings.

6.8. 4 ... 20 mA

Setup → 4 - 20 mA

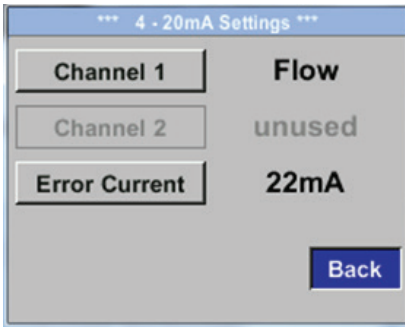

On this screen, you can adjust the settings for the 4 ... 20 mA current output.

Setup → 4 - 20 mA → Channel 1

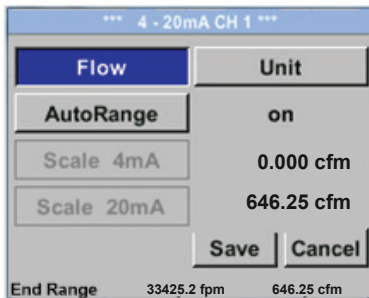

The following measurements can be configured:

- Flow
- Velocity
- Temperature
- unused = deactivate channel

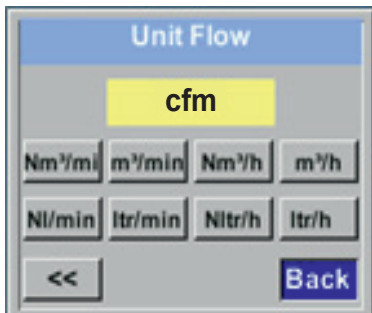

The screenshot to the left shows the available units for flow. Press the "<<" button to call up the next screen.

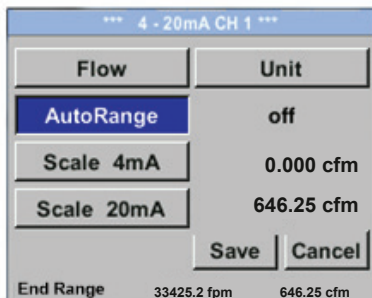

The scaling of the 4 ... 20 mA current output can be set to automatic ("AutoRange = on") or manual ("AutoRange = off").

With "AutoRange = on", the sensor automatically calculates the valid measuring range and associated reference conditions, based on the set pipe diameter.

Select "Scale 4mA" and "Scale 20mA" to manually configure the scaling of the output (precondition: "AutoRange = off").

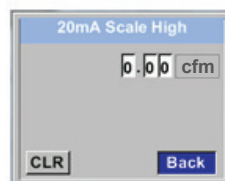
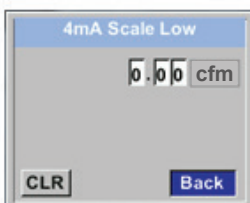

Enter the scale of the current output for 4 mA and 20 mA respectively.

Setup → 4 - 20 mA → Error Current

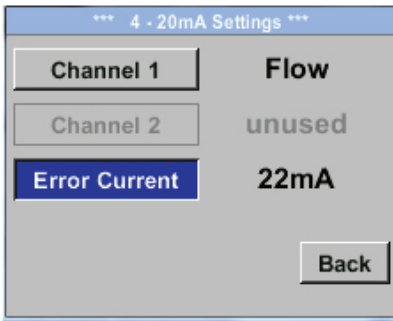

On this screen, you can enter the error signal to be sent by the current output in the event of a fault.

- 2 mA = sensor fault / system error
- 22 mA = sensor fault / system error
- None = output according to Namur (3.8 mA ... 20.5 mA)
 - < 4 mA to 3.8 mA = value below measuring range
 - > 20 mA to 20.5 mA = value above measuring range

Confirm your entry by pressing the >>ENTER<< button.

6.9. Info

Setup → Info

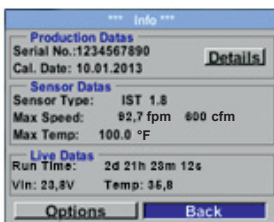

This screen shows device information.

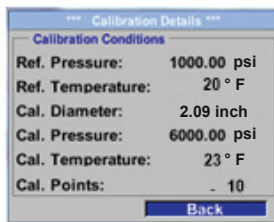

Press "Details" to view the calibration conditions.

6.10. MBus

6.10.1. Default communication settings

Primary address*: 1
 ID: Serial number of sensor
 Baud rate*: 2400
 Medium*: Gas

6.10.2. Transferred values

Value 1 with [Unit]*: Flow [cfm]
 Value 2 with [Unit]*: Consumption [cf]
 Value 3 with [Unit]*: Velocity [fpm]
 Value 4 with [Unit]*: Gas temperature [°F]

* these values can be factory-set or changed on request.

7. Spare parts and accessories

The accessories available for the METPOINT® FLM are listed in the table below.

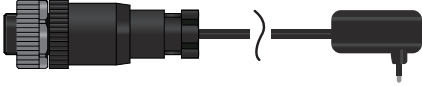
Designation	Picture
Power supply with plug-type connector A Part. no. 4032115	

8. Maintenance and servicing

Regularly check the sensor head for dirt and clean it, if necessary. Dirt, dust or oil deposits on the sensor element can cause incorrect measurements.

We recommend checking the sensor element at least once a year. If the compressed air is heavily contaminated, choose a shorter interval.

9. Cleaning sensor head

To clean the sensor head, immerse it in warm water with a little detergent. Do not clean the sensor with a cloth, sponge, brush or other implement, as any mechanical impact can destroy the sensor. In the event of persistent deposits, return the sensor to the manufacturer for inspection and cleaning.

10. Calibration

If the device is not custom-configured, we recommend having it calibrated every 12 months. For calibration, send the METPOINT® FLM to BEKO TECHNOLOGIES Corporation.

11. LED indicator

The METPOINT® FLM features a LED calibration indicator mounted at the top of the housing. After 15 months, the LED begins to flash, indicating that the device needs to be calibrated. The flashing LED does not have any effect on the measuring process, and the device continues to provide accurate measuring signals.

On request, the calibration interval can be adjusted at the factory.

12. Declaration of Conformity

BEKO TECHNOLOGIES GMBH
 Im Taubental 7
 41468 Neuss, GERMANY
 Tel: +49 2131 988-0
 www.beko-technologies.com



EU-Konformitätserklärung

Wir erklären hiermit, dass die nachfolgend bezeichneten Produkte den Anforderungen der einschlägigen Richtlinien und technischen Normen entsprechen. Diese Erklärung bezieht sich nur auf die Produkte in dem Zustand, in dem sie von uns in Verkehr gebracht wurden. Nicht vom Hersteller angebrachte Teile und/oder nachträglich vorgenommene Eingriffe bleiben unberücksichtigt.

Produktbezeichnung:	METPOINT® FLM
Typ:	SF53 und SF13
Spannungsversorgung:	18 ... 36 VDC
IP-Schutzart	IP65
Max. Betriebsdruck:	16 bar(g)
Min. / Max. Betriebstemperatur:	-30°C / +80°C
Datenblatt:	DB_FLM-0916-FP-A
Produktbeschreibung und Funktion:	Thermischer Massen-Durchflussmesser für Druckluft

Druckgeräte-Richtlinie 2014/68/EU

Die Produkte fallen in keine Druckgerätekategorie und sind gemäß Artikel 4 Absatz 3 in Übereinstimmung mit der in den Mitgliedstaaten geltenden guten Ingenieurspraxis ausgelegt und werden dieser entsprechend hergestellt.

EMV-Richtlinie 2014/30/EU

Angewandte harmonisierte Normen: EN 61326-1:2013, EN 61326-2-3:2013

ROHS II-Richtlinie 2011/65/EU

Die Vorschriften der Richtlinie 2011/65/EU zur Beschränkung der Verwendung bestimmter gefährlicher Stoffe in Elektro- und Elektronikgeräten werden erfüllt.

Die Produkte sind mit dem abgebildeten Zeichen gekennzeichnet:



Die alleinige Verantwortung für die Ausstellung dieser Konformitätserklärung trägt der Hersteller.

Neuss, 27.03.2017

Unterzeichnet für und im Namen von:

BEKO TECHNOLOGIES GMBH

i.V. Christian Riedel

Leiter Qualitätsmanagement International

CE_FLM-896-0317-FP-A

BEKO TECHNOLOGIES GMBH
 Im Taubental 7
 41468 Neuss, GERMANY
 Phone: +49 2131 988-0
 www.beko-technologies.com



EU Declaration of Conformity

We hereby declare that the products named below comply with the stipulations of the relevant directives and technical standards. This declaration only refers to products in the condition in which they have been placed into circulation. Parts which have not been installed by the manufacturer and/or modifications which have been implemented subsequently remain unconsidered.

Product designation:	METPOINT® FLM
Types:	SF53 and SF13
Power supply:	18 ... 36 VDC
IP protection rating	IP65
Max. operating pressure:	16 bar(g)
Min./max. operating temperature:	-22°F (-30°C) / +176°F (80°C)
Data sheet:	DB_FLM-0916-FP-A
Product description and function:	Thermal flow meter for compressed air

Pressure Equipment Directive 2014/68/EU

The products are not classified in any pressure equipment category. In accordance to article 4, section 3, they have been designed and manufactured according to sound engineering practice as applicable in the EU member states.

EMC Directive 2014/30/EU

Applied harmonized standards: EN 61326-1:2013, EN 61326-2-3:2013

RoHS II Directive 2011/65/EU

The products meet the requirements laid down in European Directive 2011/65/EU concerning the restriction of the use of certain hazardous substances in electrical and electronic devices.

The products bear the CE Mark:



This Declaration of Conformity has been issued by the manufacturer.

Neuss, 25/10/2016

Signed on behalf of:
BEKO TECHNOLOGIES GMBH

ppa Christian Riedel
 Head of International Quality Management

CE_FLM-896-0916-FP-A

BEKO TECHNOLOGIES GmbH

Im Taubental 7
 D - 41468 Neuss
 Tel. +49 2131 988 0
 Fax +49 2131 988 900
 info@beko-technologies.com
 service-eu@beko-technologies.com

DE**BEKO TECHNOLOGIES LTD.**

Unit 11-12 Moons Park
 Burnt Meadow Road
 North Moons Moat
 Redditch, Worcs, B98 9PA
 Tel. +44 1527 575 778
 info@beko-technologies.co.uk

GB**BEKO TECHNOLOGIES S.à.r.l.**

Zone Industrielle
 1 Rue des Frères Rémy
 F - 57200 Sarreguemines
 Tél. +33 387 283 800
 info@beko-technologies.fr
 service@beko-technologies.fr

FR**BEKO TECHNOLOGIES B.V.**

Veenen 12
 NL - 4703 RB Roosendaal
 Tel. +31 165 320 300
 benelux@beko-technologies.com
 service-bnl@beko-technologies.com

NL**BEKO TECHNOLOGIES (Shanghai) Co. Ltd.**

Rm.715 Building C, VANTONE Center
 No.333 Suhong Rd.Minhang District
 201106 Shanghai
 Tel. +86 (21) 50815885
 info.cn@beko-technologies.cn
 service1@beko.cn

CN**BEKO TECHNOLOGIES s.r.o.**

Na Pankraci 58
 CZ - 140 00 Praha 4
 Tel. +420 24 14 14 717 /
 +420 24 14 09 333
 info@beko-technologies.cz

CZ**BEKO Tecnológica España S.L.**

Torruella i Urpina 37-42, nave 6
 E - 08758 Cervelló
 Tel. +34 93 632 76 68
 Mobil +34 610 780 639
 info.es@beko-technologies.es

ES**BEKO TECHNOLOGIES LIMITED**

Room 2608B, Skyline Tower,
 No. 39 Wang Kwong Road
 Kwoloon Bay Kwoloon, Hong Kong
 Tel. +852 2321 0192
 Raymond.Low@beko-technologies.com

HK**BEKO TECHNOLOGIES INDIA Pvt. Ltd.**

Plot No.43/1 CIEEP Gandhi Nagar
 Balanagar Hyderabad
 IN - 500 037
 Tel. +91 40 23080275 /
 +91 40 23081107
 Madhusudan.Masur@bekoindia.com
 service@bekoindia.com

IN**BEKO TECHNOLOGIES S.r.l**

Via Peano 86/88
 I - 10040 Leinì (TO)
 Tel. +39 011 4500 576
 Fax +39 0114 500 578
 info.it@beko-technologies.com
 service.it@beko-technologies.com

IT**BEKO TECHNOLOGIES K.K**

KEIHIN THINK Building 8 Floor
 1-1 Minamiwatarida-machi
 Kawasaki-ku, Kawasaki-shi
 JP - 210-0855
 Tel. +81 44 328 76 01
 info@beko-technologies.jp

JP**BEKO TECHNOLOGIES Sp. z o.o.**

ul. Pańska 73
 PL - 00-834 Warszawa
 Tel. +48 22 314 75 40
 info.pl@beko-technologies.pl

PL**BEKO TECHNOLOGIES S. de R.L. de C.**

BEKO Technologies, S de R.L. de C.V.
 Blvd. Vito Alessio Robles 4602 Bodega 10
 Zona Industrial
 Saltillo, Coahuila, 25107
 Mexico
 Tel. +52(844) 218-1979
 informacion@beko-technologies.com

MX**BEKO TECHNOLOGIES CORP.**

900 Great Southwest Pkwy SW
 US - Atlanta, GA 30336
 Tel. +1 404 924-6900
 Fax +1 (404) 629-6666
 beko@bekousa.com

US