



EN - English

Installation and operation instructions

Thermal flow meter

METPOINT® FLM SF53

FLMSF53LL220 | FLMSF53DL220 | FLMSF53LL400 | FLMSF53DL400

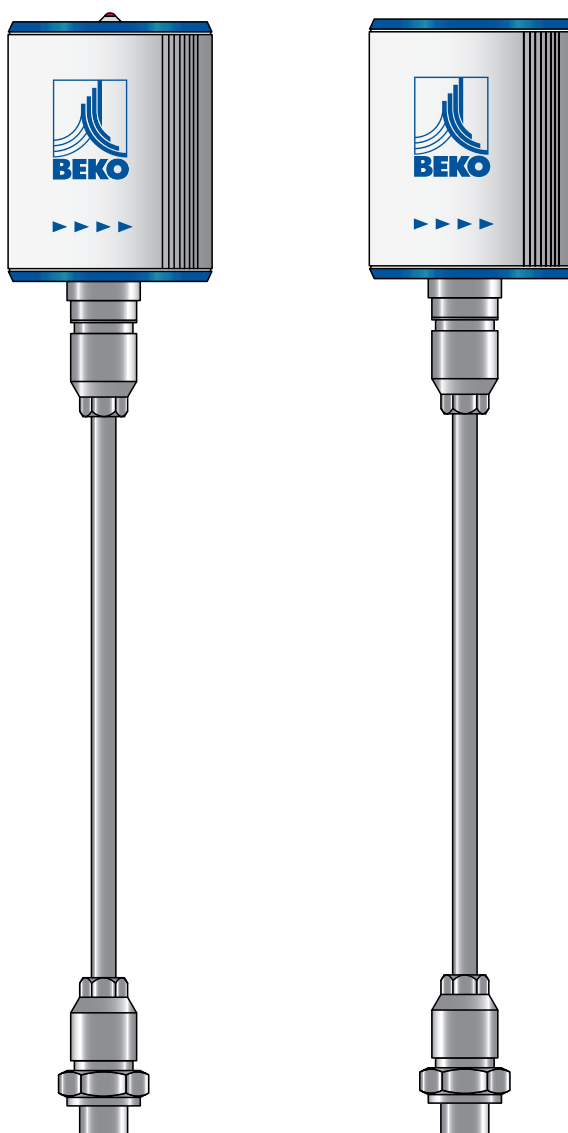

Contents

1. Safety information	4
1.1. Pictograms and symbols	4
1.1.1. In this documentation	4
1.1.2. On the device	4
1.2. Signal words	4
1.3. Safety instructions	5
1.4. Transport and storage	6
1.5. Intended use	7
1.6. Warranty and liability	7
2. Product information	8
2.1. Scope of delivery	8
2.2. Type plate	8
2.3. Product overview and description	9
2.3.1. Identification based on product code	9
2.3.2. Product description	10
2.3.3. Operating principle	10
2.4. Control and display elements	11
2.4.1. Model with display	11
2.4.2. Model with LED	11
2.4.3. Direction of flow	12
2.5. Dimensions	13
2.6. Technical data	14
2.7. Measuring ranges	15
3. Installation	17
3.1. Warning	17
3.1.1. Requirements for piping	17
3.1.2. Requirements for infeed / outfeed section	17
3.1.3. Turning the housing	18
3.2. Installation	19
4. Electrical installation	20
4.1. Pin assignment of plug-type connectors	20
4.2. Connection options	20
4.2.1. Bidirectional RS485 bus system	20
4.2.2. Current output 4 ... 20 mA, 3-wire	21
4.2.3. MBus	21
4.2.4. Galvanically isolated pulse output	22
4.3. Connection of METPOINT® BDL	23
4.3.1. Bidirectional RS485 bus system	23
4.3.2. Current output 4 ... 20 mA, 3-wire	24
4.3.3. Galvanically isolated pulse output	24
4.4. Connection to METPOINT® BDL compact	25
4.4.1. Bidirectional RS485 bus system	25
4.4.2. Current output 4 ... 20 mA, 3-wire	25
4.4.3. Galvanically isolated pulse output	26
4.5. Modbus final termination	26

5. Commissioning	27
6. Configuration and operation	27
6.1. LED signals during operation.....	27
6.2. Setup menu	28
6.3. Sensor Setup.....	28
6.3.1. Input interior pipe diameter	29
6.3.2. Entering / changing consumption counter value	29
6.3.3. Selecting units for consumption, flow, temperature and pressure	30
6.3.4. Entering reference conditions.....	31
6.3.5. Setting zero point for low-flow cut-off function	32
6.4. Modbus setup	33
6.4.1. Modbus settings (2001 ... 2005).....	34
6.4.2. Values register (1001 ...1500).....	34
6.5. Pulse / alarm.....	35
6.5.1. Pulse output	35
6.6. User Setup	36
6.7. Advanced	36
6.8. 4 ... 20 mA	37
6.9. Info	38
6.10. MBus	38
6.10.1. Default communication settings.....	38
6.10.2. Transferred values.....	38
7. Spare parts and accessories.....	39
8. Maintenance and servicing.....	39
9. Cleaning sensor head	39
10. Re-calibration	39
11. LED display	39
12. Declaration of Conformity	41

1. Safety information

1.1. Pictograms and symbols

1.1.1. In this documentation



General instructions



Observe installation and operating instructions



General hazard symbol (danger, warning, caution)



General hazard symbol (danger, warning, caution) relating to mains voltage and powered machine parts



The packaging material is recyclable. Dispose of it according to the applicable statutory regulations.



1.1.2. On the device



General instructions



General hazard symbol (danger, warning, caution)

1.2. Signal words

DANGER

Imminent danger

Consequences of non-compliance: serious or even fatal injury

WARNING

Potential danger

Consequences of non-compliance: serious or even fatal injury

CAUTION

Imminent danger



Consequences of non-compliance: injury and/or damage to property

NOTICE

Additional notes, tips and hints

Consequences of non-compliance: Disadvantages in operation and maintenance.
No risk to persons

1.3. Safety instructions

<p>DANGER</p>	<p>Escaping compressed gas</p>
	<p>Risk of serious or even fatal injury from contact with escaping compressed gas or from unsecured plant components.</p> <ul style="list-style-type: none"> • Before carrying out any assembly, installation or maintenance work, depressurize the system. All electrical work must be carried out by authorized specialist technical personnel¹. • Use only pressure-resistant installation materials and suitable tools that are in proper working order. • Before pressurizing the system, check all unit parts and repair them, if necessary. Open valves slowly to prevent pressure blows during operation. • Make sure that no persons can be injured or objects can be damaged by condensate or escaping compressed gas. • Protect the device parts against vibration and impact.
<p>DANGER</p>	<p>Mains voltage</p>
	<p>Risk of serious or even fatal injury from electric shock when coming into contact with non-insulated, powered components.</p> <ul style="list-style-type: none"> • For the electrical installation of the device, adhere to all applicable regulations (e.g. VDE 0100 / IEC 60364). • Before carrying out any maintenance work, de-energize the system. • All electrical work must be carried out by authorized specialist technical personnel¹. • The permissible operating voltage is printed on the name plate and must be strictly adhered to. • All components of the electrical installation on site must be approved and/or bear the CE mark. • A reliably accessible circuit breaker (e.g. power plug or switch) that shuts off all conductors must be installed close to the unit.
<p>WARNING</p>	<p>Operation of unit outside limit range</p>
	<p>If the specified limits are exceeded, there is a risk of device malfunction, potentially resulting in injury and/or damage to property.</p> <ul style="list-style-type: none"> • The device must only be operated for the intended purpose and within the permissible limits specified on the type plate and in the technical data. • Use high-pressure protection above 10 bar to ensure safe installation and removal. • Do not operate the device in connection with flammable gases. • Strictly adhere to the prescribed operating times and maintenance intervals. • Observe the prescribed storage and transport conditions. • Prevent condensation on the sensor element. Ensure that the air fed through the device is free of droplets.

¹Specialist technical personnel

Specialist technical personnel have the professional training, knowledge of measurement, control, regulation and compressed air technology and experience and knowledge of country-specific regulations, applicable standards and directives necessary to allow them to carry out the work described and independently recognize potential hazards. Specialized usage conditions will require additional knowledge, for instance regarding aggressive media.

1.4. Transport and storage

Despite our best efforts regarding packaging, etc., the device might be damaged during transport. Upon receipt, please remove all packaging material and inspect the product for visible damage. If you detect such damage, immediately notify the carrier company and BEKO TECHNOLOGIES GMBH or one of its agents.

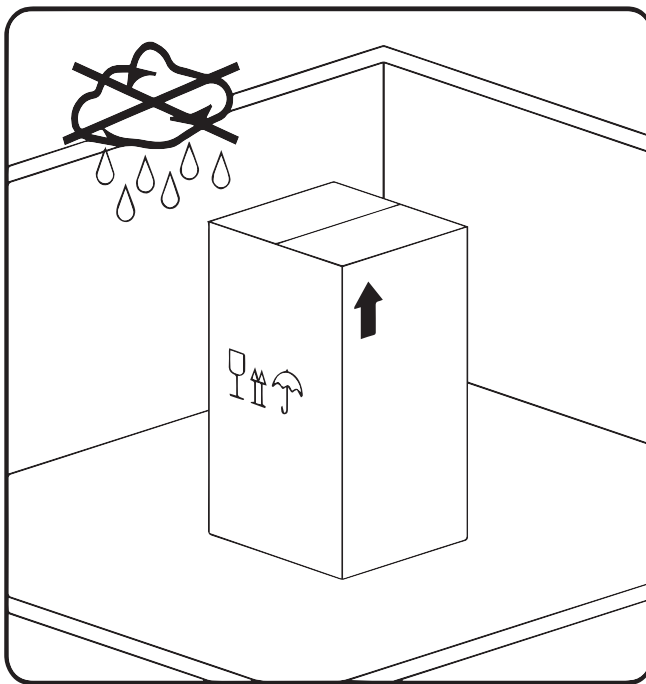

CAUTION	Damage caused during transport or storage
	<p>Incorrect transport or storage, or the use of unsuitable lifting equipment might cause damage to the device.</p> <ul style="list-style-type: none"> • The device must only be transported and stored by authorized and suitably trained technical personnel. • If you detect any damage, do not start the device. • Adhere to the permissible storage and transport temperatures (see technical data). • Protect the device against direct sunlight and heat radiation.



The device must be stored in the original packaging. Seal the packaging and store it in a dry and frost-free room. Ensure that the storage temperature does not exceed the limits specified on the type plate.

Even when packaged, take suitable measures to protect the device against the elements.

While in storage, secure the device so that it cannot topple over or fall, and protect it against vibration.

NOTICE	Recycling of packaging material
 	<ul style="list-style-type: none"> • The packaging material is recyclable. Dispose of the packaging material according to the applicable statutory regulations of the destination country.

1.5. Intended use

The METPOINT® FLM is a thermal flow meter for the measurement of volume flow, consumption and flow velocity. By default, the device is configured for the measurement of volume flow in m³/h, consumption in m³ and velocity in m/s.

- The METPOINT® FLM is primarily used in compressed air systems. On request, the sensor can be programmed by BEKO TECHNOLOGIES GmbH for the measurement of other gases: Nitrogen
- The device is not suitable for operation in potentially explosive or aggressive atmospheres.
- Protect the device against direct sunlight and heat radiation.

Operate the METPOINT® FLM only for the intended purpose and within the limit range specified in the technical data. Do not operate the unit with any media (fluids, gas/vapor mixtures) other than those listed above. Any other use of the device is deemed improper and poses a risk to persons, property and the environment.

1.6. Warranty and liability



Any liability claims shall expire if METPOINT® FLM is not used according to its intended use, or if it is operated outside of the specifications indicated in the technical data; this includes, in particular:

- Incorrect installation, commissioning or operation; insufficient maintenance
- Operation with defective components
- Non-compliance with the instructions in this document, in particular the safety instructions
- Execution of construction related interactions or modifications of the device
- Non-compliance with the prescribed maintenance intervals
- Use of third-party spare parts that have not been approved by the manufacturer

2. Product information

2.1. Scope of delivery

The table below shows the scope of delivery of the METPOINT® FLM.

Designation	Picture
Calibration certificate	
Connecting cable (5-wire)	
Aligning aid	

2.2. Type plate

The name plate is attached to the device housing. It contains all relevant technical data of the METPOINT® FLM. Please have these details to hand when contacting the manufacturer or supplier:

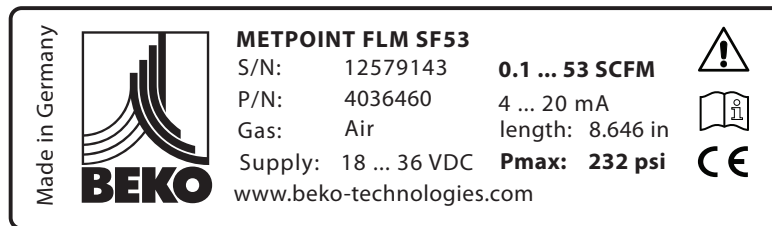

Designation	Description
METPOINT® FLM SF53	Type designation
S/N: 12579143	Serial number
P/N: 4036460	Product number
Gas: air	Media
Supply: 18 ... 36 VDC	Power supply rating
0.1 ... 53 scfm	Min./max. measuring range
4 ... 20 mA	Min./max. Data of analog output
length: 8.646 in	Length of sensor tube
Pmax: 232 psi	Max. permitted operating overpressure

NOTICE	Handling of type plate
	Do not remove or cover the name plate, and protect it against damage. For more information regarding the symbols printed on the type plate, see “Pictograms and symbols” on page 4.

2.3. Product overview and description

2.3.1. Identification based on product code

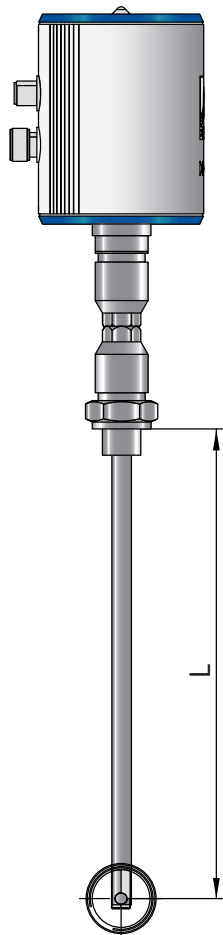
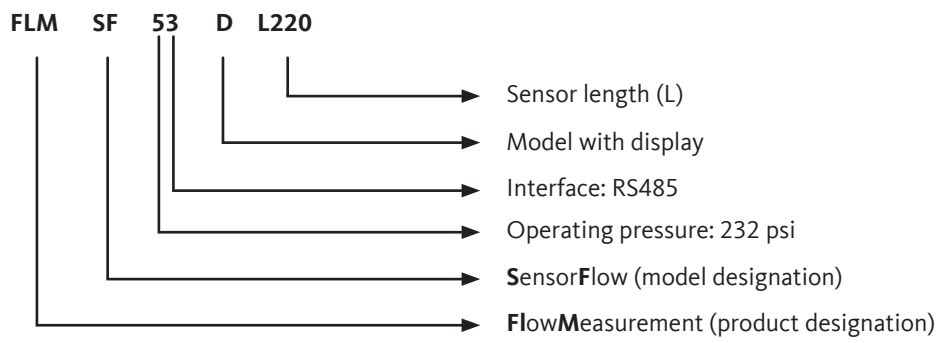

2.3.2. Product description

The METPOINT® FLM thermal flow meter measures the volume flow, which forms the basis for intelligent energy management. It can be used to identify potential savings, overloads and weak points in a system to improve its efficiency. By measuring the actual flow to the various production units, operators are in a position to make decisions based on facts. At the same time, the METPOINT® FLM lets them know whether there are any leaks in their system. The METPOINT® FLM thus provides all the information operators need to correctly dimension and configure their system systems and components for improved efficiency. The device is equipped with a Modbus RTU(RS485) interface, a 4 ... 20 mA current output, as well as a galvanically insulated pulse output and an optional MBus interface.

2.3.3. Operating principle

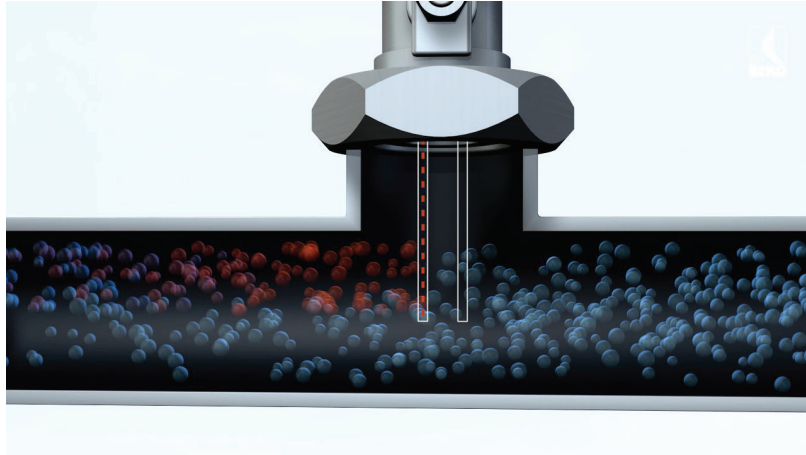



Two temperature sensors are installed in series in the direction of flow. The first temperature sensor measures the current process temperature, while the second sensor is electrically heated to a temperature that is exactly 40 K above the temperature measured by the first sensor. As the mass or volume flow increases, the temperature sensors would normally cool off, but the electric heater of the second heater prevents that from occurring.

The electric energy required to maintain the temperature difference is directly proportional to the mass flow. As the mass flow increases, so does the heating power, which is then converted into the appropriate measured value. Taking into account the inside diameter of the pipe, the METPOINT® FLM determines the exact mass flow.

2.4. Control and display elements

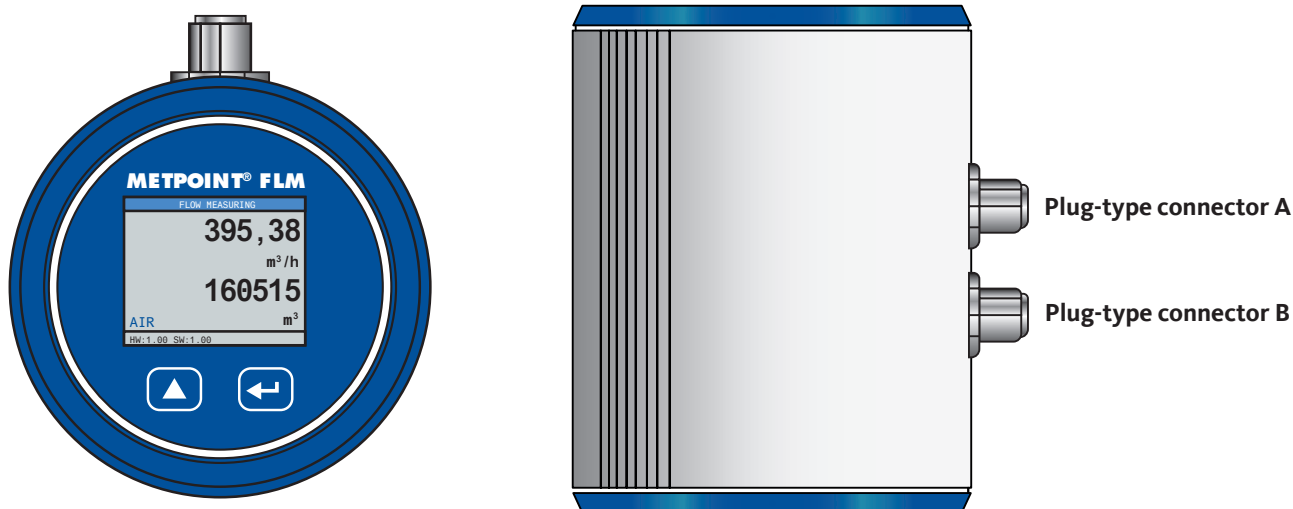
2.4.1. Model with display



NOTICE	Additional information
	For more information regarding the operation of the device, see “Configuration and operation” on page 27.

2.4.2. Model with LED

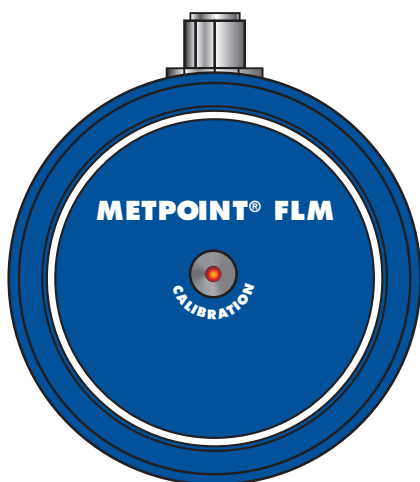



There is an LED on the top of the METPOINT® FLM housing, which is used to indicate the calibration time. The light flashes after 15 months to indicate there is an upcoming re-calibration. The flashing LED does not influence measured values. The measurement signal is still output.

The time interval can be adjusted as requested by the customer in the manufacturing plant.

2.4.3. Direction of flow

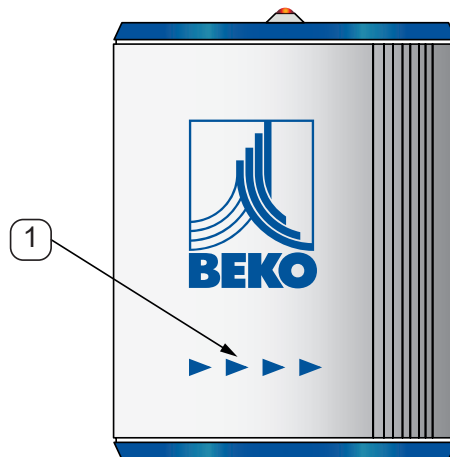
The direction of flow is indicated by the arrows (1) on the housing and on the probe tube of the METPOINT® FLM.



NOTICE	Additional information
	If necessary, turn the housing (e.g. to change the direction of flow through the device). For more information, see “Turning the housing” on page 18.

2.5. Dimensions

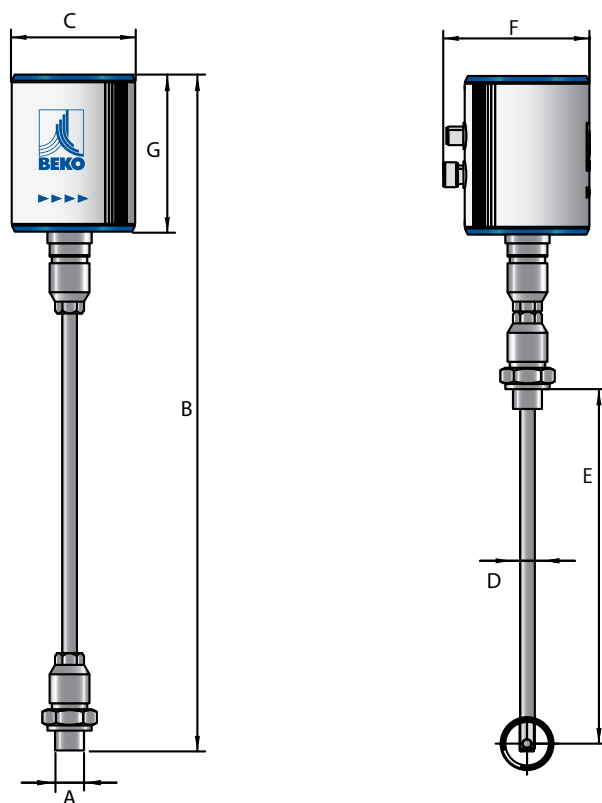
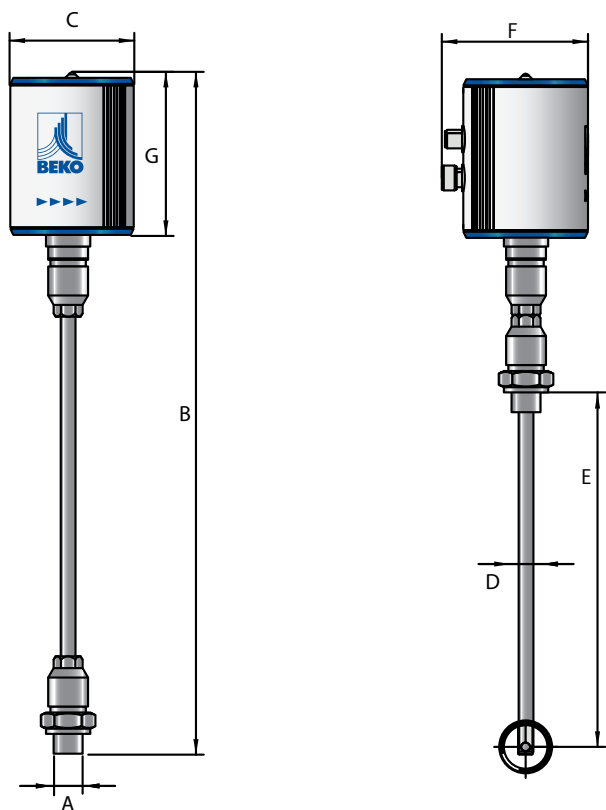

Dimensions		
	Model with display	Model with LED
A	G½" (ISO 228/1)	
B (in)	16.34 (Standard)	16.48 (Standard)
C (in)	3.15	
D (in)	Ø 0.46	
E (in)	8.66 (Standard), optional: 15.75	
F (in)	3.70	
G (in)	4.02	4.15

2.6. Technical data

Technical data	
	SF53
Max. operating pressure	232 psi, optional 725 psi
Measuring technique	Calorimetric
Operating temperature	Sensor tube and fittings: -30 ... +140 °C (-22 ... +284 °F) Housing: -30 ... +80 °C (-22 ... +176 °F)
Measured parameters	m ³ /h (factory settings) On the display version, the following units can be chosen: m ³ /min, l/min, l/s, ft/min, cfm, m/s, kg/min, kg/s
Sensor	Pt45, Pt1000
Media	Compressed air, nitrogen
Humidity of medium	max. 90 % rH (no droplets)
Power supply	18 ... 36 VDC
Power consumption	max. 5 W
Digital output	RS485 (Modbus RTU)
Analog output	4 ... 20 mA (max. load < 500 Ω)
Pulse output	Floating switch contact Passive: max. 48 VDC 150 mA 1 pulse per m ³ or per liter Unit adjustable at display
Accuracy	± 1.5 % of measured value ± 0.3 % of final value
Display/indicator	Display: TFT 1.8" (resolution: 220 x 167) or service LED
Screw fitting	G½ (ISO 228/1)
Material	Sensor tube and fittings: 1.4301 stainless steel Housing: Powder-coated aluminum Flange: 1.4404 (DIN EN 1092-1)

2.7. Measuring ranges

The METPOINT® FLM can measure flow velocities up to 185.0 m/s and is preconfigured for an inside pipe diameter of 53.1 mm. At the analog output of 4 ... 20 mA, this corresponds to:

Rated diameter	Ø interior		Volume flow (measuring range limit value in scfm)			V max.		
	Zoll	mm	in	Luft *	Luft **	N ₂ **	m/s	ft/s
1/4"		6.0	0.24	5.53	5.12	5.12	185.0	606.95
		10.0	0.39	17.54	16.13	16.13	185.0	606.95
		15.0	0.59	45.73	42.02	42.02	185.0	606.95
1/2"		16.1	0.63	53.56	49.26	49.26	185.0	606.95
3/4"		21.7	0.85	104.65	96.23	96.23	185.0	606.95
1"		25.0	0.98	143.55	132.02	132.02	185.0	606.95
		26.0	1.02	156.09	143.55	143.55	185.0	606.95
		27.3	1.07	173.45	159.5	159.5	185.0	606.95
		28.5	1.12	190.29	174.98	174.98	185.0	606.95
		30.0	1.18	212.54	195.41	195.41	185.0	606.95
1 1/4"		32.8	1.29	257.03	236.37	236.37	185.0	606.95
		36.0	1.42	312.83	287.64	287.64	185.0	606.95
		36.3	1.43	318.48	292.88	292.88	185.0	606.95
1 1/2"		39.3	1.55	376.57	346.32	346.32	185.0	606.95
		40.0	1.57	390.64	359.21	359.21	185.0	606.95
		41.9	1.65	428.72	394.23	394.23	185.0	606.95
		43.1	1.70	457.5	420.72	420.72	185.0	606.95
		45.8	1.80	519.24	477.45	477.45	185.0	606.95
2"		50.0	1.97	623.42	573.33	573.33	185.0	606.95
		51.2	2.02	654.56	601.88	601.88	185.0	606.95
		53.1	2.09	704.88	648.2	648.2	185.0	606.95
	54.5	2.15	743.43	683.69	683.69	185.0	606.95	
	57.5	2.26	877.92	807.35	807.35	185.0	606.95	
	60.0	2.36	908.82	835.78	835.78	185.0	606.95	
2 1/2"		64.2	2.53	1044.31	960.38	960.38	185.0	606.95
		65.0	2.56	1071.8	985.63	985.63	185.0	606.95
		70.3	2.77	1258.32	1157.14	1157.14	185.0	606.95
		71.1	2.80	1287.1	1183.63	1183.63	185.0	606.95
		76.1	3.00	1478.04	1359.2	1359.2	185.0	606.95

* According to DIN 1945 / ISO 1217 (20°C, 1000 mbar), with compressed air.

** Adjustment for DIN 1343: 0°C, 1013.25 mbar

Rated diameter	Ø interior		Volume flow (measuring range limit value in scfm)			V max.	
	Zoll	mm	in	Luft *	Luft **	N ₂ **	m/s
3"	80.0	3.15	1637.36	1505.7	1505.7	185.0	606.95
	82.5	3.25	1741.31	1601.28	1601.28	185.0	606.95
	84.9	3.34	1844.07	1695.81	1695.81	185.0	606.95
	90.0	3.54	2074.8	1907.99	1907.99	185.0	606.95
4"	100.0	3.94	2564.55	2358.37	2358.37	185.0	606.95
	107.1	4.22	2945.18	2708.34	2708.34	185.0	606.95
	110.0	4.33	3106.87	2857.02	2857.02	185.0	606.95
5"	125.0	4.92	4016.75	3693.74	3693.74	185.0	606.95
	133.7	5.26	4595.32	4225.81	4225.81	185.0	606.95
6"	150.0	5.91	5791.02	5325.39	5325.39	185.0	606.95
	159.3	6.27	6531.39	6006.2	6006.2	185.0	606.95
	182.5	7.19	8582.58	7892.47	7892.47	185.0	606.95
	190.0	7.48	9302.53	8554.51	8554.51	185.0	606.95
8"	200.0	7.87	10319.83	9489.99	9489.99	185.0	606.95
	206.5	8.12	11001.52	10116.89	10116.89	185.0	606.95
10"	250.0	9.84	16143.98	14845.82	14845.82	185.0	606.95
	260.4	10.25	17535.97	16125.91	16125.91	185.0	606.95
12"	300.0	11.81	23275.01	21403.45	21403.45	185.0	606.95
	309.7	12.19	24804.43	22809.92	22809.92	185.0	606.95
	339.6	13.37	29825.18	27426.96	27426.96	185.0	606.95
	388.8	15.31	41377.78	38050.61	38050.61	185.0	606.95
	500.0	19.69	64652.8	59454.12	59454.12	185.0	606.95
	600.0	23.62	93100	85613.94	85613.94	185.0	606.95
	700.0	27.56	126719.44	116530.04	116530.04	185.0	606.95
	800.0	31.50	165511.13	152202.51	152202.51	185.0	606.95
900.0	35.43	209475.07	192631.32	192631.32	185.0	606.95	
1000.0	39.37	258611.13	237816.44	237816.44	185.0	606.95	

* According to DIN 1945 / ISO 1217 (20°C, 1000 mbar), with compressed air.

** Adjustment for DIN 1343: 0°C, 1013.25 mbar

3. Installation

3.1. Warning

DANGER	Escaping compressed gas
	<p>Risk of serious or even fatal injury from contact with escaping compressed gas or from unsecured plant components.</p> <ul style="list-style-type: none"> • Before carrying out any assembly, installation or maintenance work, depressurize the system. Such work must be carried out by authorized specialist technical personnel only (see “Safety instructions” on page 5). • Use high-pressure protection above 145 psi to ensure safe installation and removal. • Tighten the clamping sleeve with a torque of 14.75 ... 22.13 ft lb (wrench size 27). • Use only pressure-resistant installation materials and suitable tools that are in proper working order. • Before pressurizing the system, check all unit parts and repair them, if necessary. Open valves slowly to prevent pressure blows during operation.

3.1.1. Requirements for piping

- Correctly dimensioned gaskets.
- Correctly installed and aligned flanges and gaskets.
- Differences in pipe diameters at joints should not exceed 1 mm. For more information, see ISO 14511.
- Clean, properly installed pipes.

3.1.2. Requirements for infeed / outfeed section

The following table shows the required infeed sections, depending on the direction of flow.

Table of additional inlet pipe sections required in specific cases

Flow obstruction <i>upstream</i> of measuring section	Minimum length of inlet pipe section (L1)	Minimum length of outlet pipe section (L-L1)
Slight bend (angle < 90°)	12 x D	5 x D
Reduction (pipe diameter becomes smaller towards measuring section)	15 x D	5 x D
Enlargement (pipe diameter becomes larger towards measuring section)	15 x D	5 x D
90° elbow section or T-piece	15 x D	5 x D
2x 90° elbow sections in a plane	20 x D	5 x D
2x 90° elbow sections change of direction in 3 dimensions	35 x D	5 x D
Shut-off valve	45 x D	5 x D

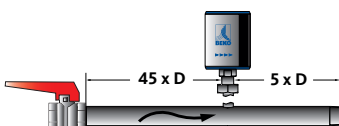
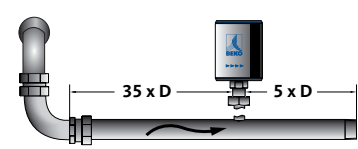
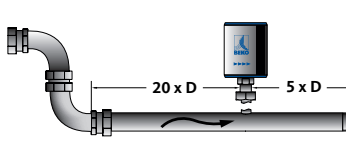
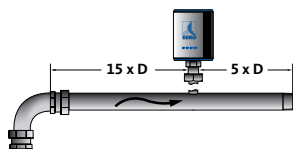
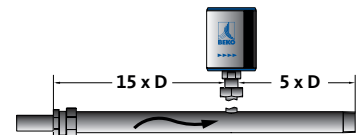
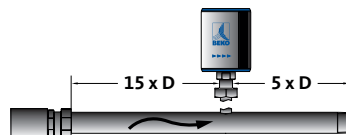
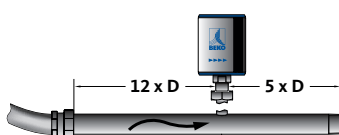

NOTICE	Deviating measurements
	The above values are required minimum values. If the recommended settling sections cannot be implemented, the measuring deviations might be much greater.

3.1.3. Turning the housing

If the direction of flow changes, the housing can be turned by loosening 4 grub screws with 0.059 in hexagon socket to the desired position. Then tighten the grub screws again by hand.

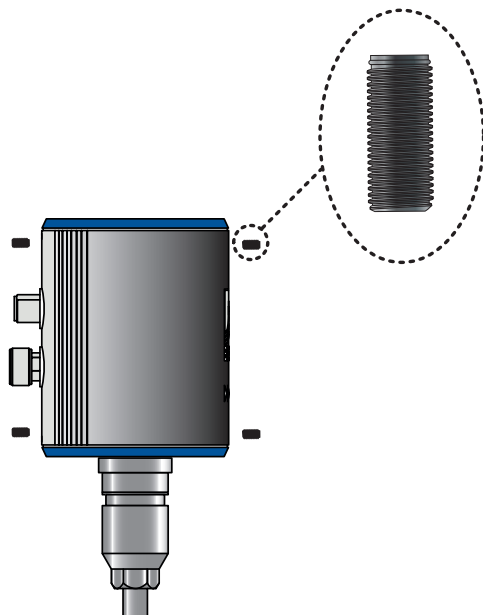

NOTICE	Risk of damage to device
	<ul style="list-style-type: none">• Ensure that the connecting pipes are correctly mounted and that the gaskets are installed properly.• Then align the sensor in the direction of flow using the alignment aid.

3.2. Installation

The sensor is installed by means of a ½, DN 15 ball valve (min. Ø 0.591 in).

Install the straight fitting with the O-ring (G½ thread, wrench size 32) in the connecting nozzle. Ensure that the assembly is pressure-tight.

Place the sensor head at the center of the tube and aligned it to the direction of flow. To do this, the sensor tube is equipped with a depth scale, arrows indicating the direction of flow and an aligning aid. After the sensor is correctly positioned and aligned, tighten the slotted spring pin with a torque of 14.75 ... 22.13 ft lb (wrench size 27).

When tightening the straight fitting and the slotted spring pin, take care not to change the alignment of the sensor. Otherwise, you might need to correct the sensor position and alignment. The angle of the sensor should not deviate by more than ± 2° from the ideal position. Larger angles might result in inaccurate measurement.

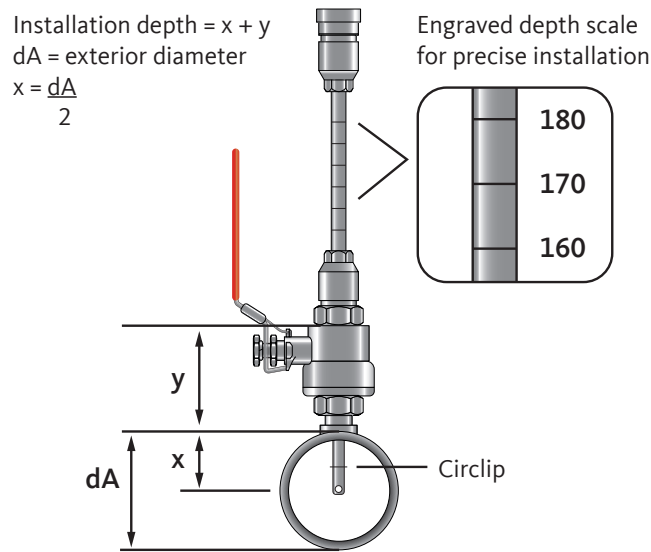

The high-pressure protection device (Art. No. 4025892) must be used above a working overpressure of >145 psi. This allows for assembly under pressure and allows the sensor to be attached securely to the measurement point.



NOTICE	Additional information
	Further information on mounting the high-pressure protection device is available from the enclosed installation and operating manual.

4. Electrical installation

4.1. Pin assignment of plug-type connectors

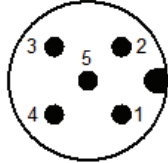
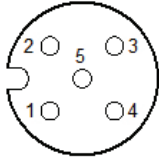
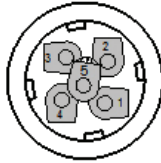
Pin assignment of plug-type connector A, M12 x 1, 5-pin, A-coded (according to EN 61076-2-101)		
Pin assignment of connector Transmitter side	Pin assignment of connector Socket side	Pin assignment of connector Screw side
		

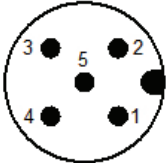
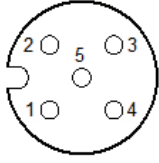
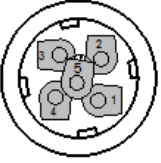
Pin assignment of plug-type connector B, M12 x 1, 5-pin, A-coded (according to EN 61076-2-101)		
Pin assignment of connector Transmitter side	Pin assignment of connector Socket side	Pin assignment of connector Screw side
		

4.2. Connection options

4.2.1. Bidirectional RS485 bus system

Connection by means of plug-type connector A.

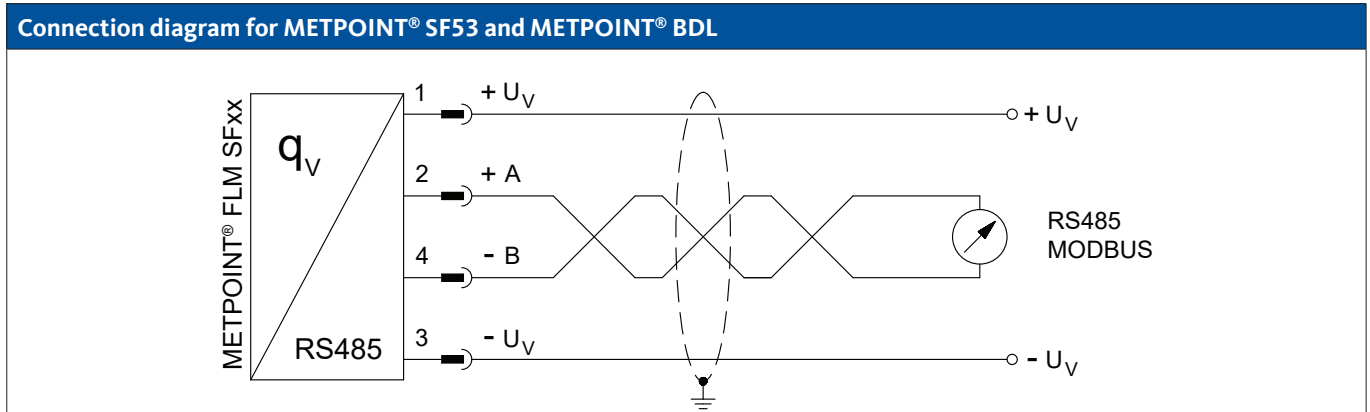

Pin assignment - sensor		Function	Wire color
PIN-1	+ U _v	Plus (+) connection, power supply	brown
PIN-2	Bus A (+)	Non-inverted signal (+) from RS485 interface	white
PIN-3	- U _v	Minus (-) connection, power supply	blue
PIN-4	Bus B (-)	Inverted signal (-) from RS485 interface	black

4.2.2. Current output 4 ... 20 mA, 3-wire

Connection by means of plug-type connector A.

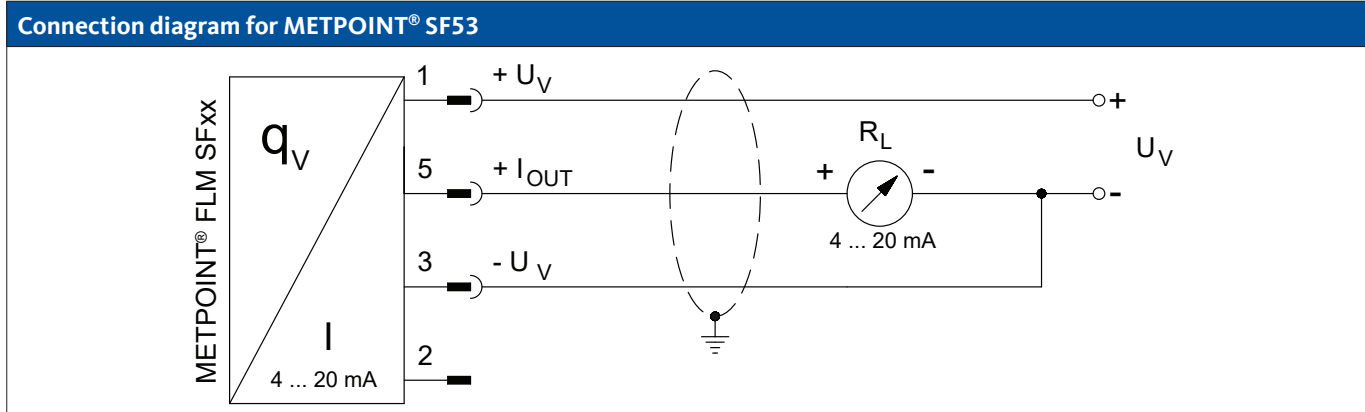

Pin assignment - sensor		Function	Wire color
PIN-1	+ U _v	Plus (+) connection, power supply	brown
PIN-2		not assigned	white
PIN-3	- U _v	Minus (-) connection, power supply	blue
PIN-4		not assigned	black
PIN-5	+ I _{OUT}	Current output	gray

4.2.3. MBus

Connection by means of plug-type connector B.

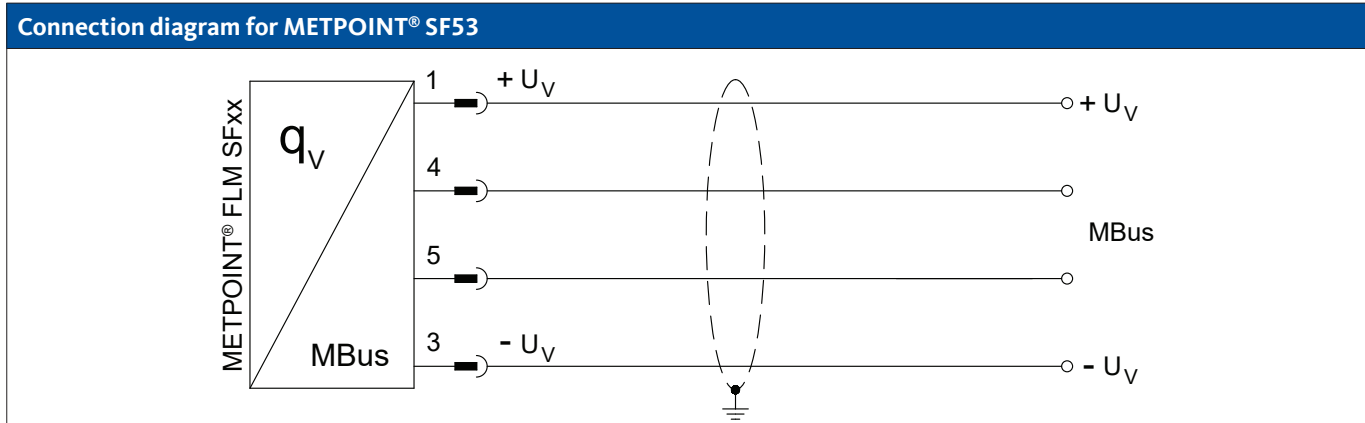

Pin assignment - sensor		Function	Wire color
PIN-1		not assigned	brown
PIN-2		not assigned	white
PIN-3		not assigned	blue
PIN-4	MBus	MBus	black
PIN-5	MBus	MBus	gray

4.2.4. Galvanically isolated pulse output

Connection by means of plug-type connector B.

Connection diagram for METPOINT® SF53

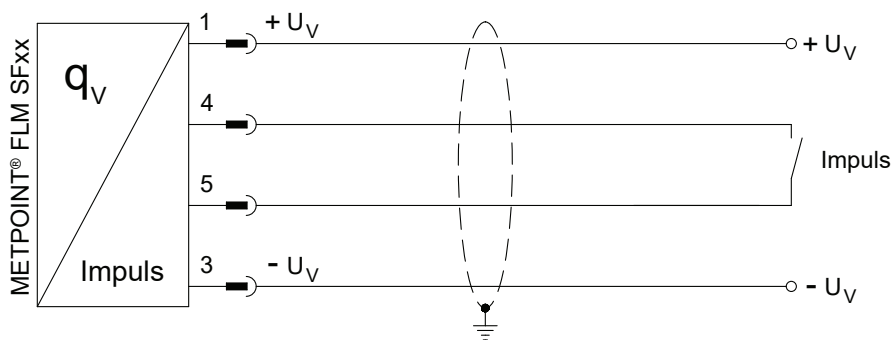

Pin assignment - sensor		Function	Wire color
PIN-1		not assigned	brown
PIN-2		not assigned	white
PIN-3		not assigned	blue
PIN-4	Pulse	Galvanically isolated pulse	black
PIN-5	Pulse	Galvanically isolated pulse	gray

4.3. Connection of METPOINT® BDL

4.3.1. Bidirectional RS485 bus system

Connection by means of plug-type connector A.

Connection diagram for METPOINT® SF53 and METPOINT® BDL

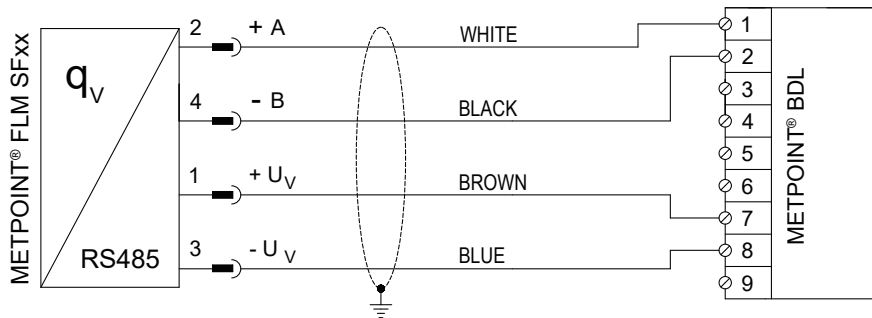

Pin assignment - sensor		Function	Wire color	Pin assignment - BDL	
PIN-1	+ U _v	Plus (+) connection, power supply	brown	PIN-7	+ U _v
PIN-2	Bus A (+)	Non-inverted signal (+) from RS485 interface	white	PIN-1	(+) A / RS485
PIN-4	Bus B (-)	Inverted signal (-) from RS485 interface	black	PIN-2	(-) B / RS485
PIN-3	- U _v	Minus (-) connection, power supply	blue	PIN-8	- U _v

4.3.2. Current output 4 ... 20 mA, 3-wire

Connection by means of plug-type connector A.

Connection diagram for METPOINT® SF53 and METPOINT® BDL

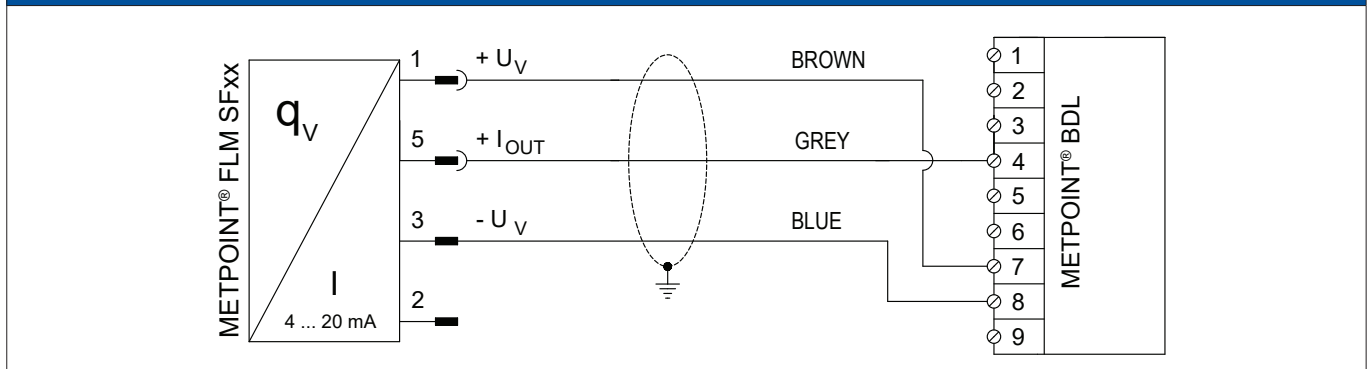

Pin assignment - sensor		Function	Wire color	Pin assignment - BDL	
PIN-1	+ U _v	Plus (+) connection, power supply	brown	PIN-7	+ U _v
PIN-5	+ I _{OUT}	Current output	gray	PIN-4	Analog IN (+)
PIN-3	- U _v	Minus (-) connection, power supply	blue	PIN-8	- U _v
PIN-2		not assigned	white		
PIN-4		not assigned	black		

4.3.3. Galvanically isolated pulse output

Connection by means of plug-type connector B.

Connection diagram for METPOINT® SF53 and METPOINT® BDL

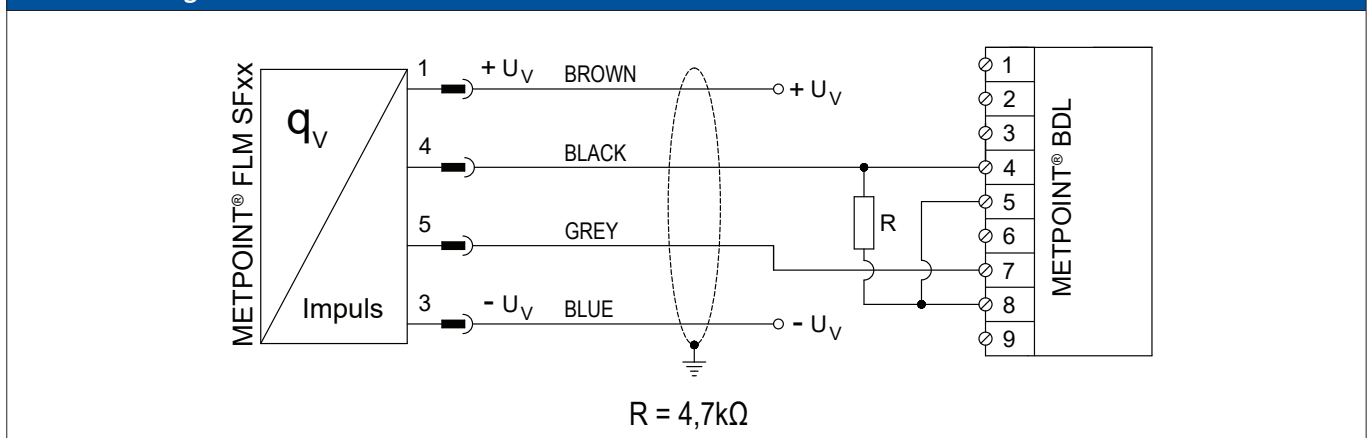

Pin assignment - sensor		Function	Wire color	Pin assignment - BDL	
PIN-1	+ U _v	Plus (+) connection, power supply	brown		
PIN-4	Pulse	Pulse	black	PIN-4	Analog IN (+)
PIN-5	Pulse	Pulse	gray	PIN-7	+ U _v
PIN-3	- U _v	Minus (-) connection, power supply	blue		
PIN-2		not assigned	white		

4.4. Connection to METPOINT® BDL compact

4.4.1. Bidirectional RS485 bus system

Connection by means of plug-type connector A.

Connection diagram for METPOINT® SF53 and METPOINT® BDL compact (digital board)

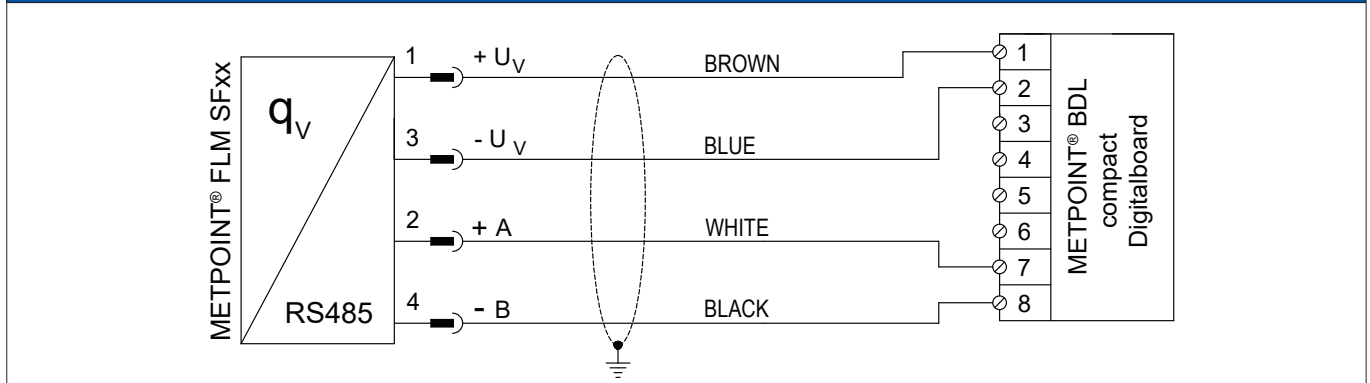

Pin assignment - sensor		Function	Wire color	Pin assignment - BDL compact	
PIN-1	+ U _V	Plus (+) connection, power supply	brown	PIN-1	+ U _V
PIN-3	- U _V	Minus (-) connection, power supply	blue	PIN-2	- U _V
PIN-2	+ A	Non-inverted signal (+) from RS485 interface	white	PIN-7	(+) RS485 (A)
PIN-4	- B	Inverted signal (-) from RS485 interface	black	PIN-8	(-) RS485 (B)
PIN-5		not assigned	gray		

4.4.2. Current output 4 ... 20 mA, 3-wire

Connection by means of plug-type connector A.

Connection diagram for METPOINT® SF53 and METPOINT® BDL compact (analog board)

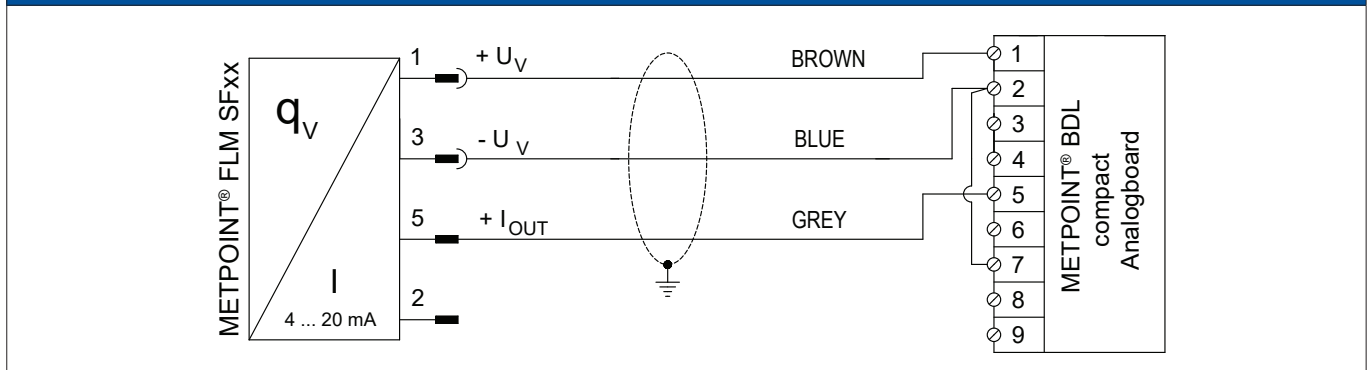

Pin assignment - sensor		Function	Wire color	Pin assignment - BDL compact	
PIN-1	+ U _V	Plus (+) connection, power supply	brown	PIN-1	+ U _V
PIN-3	- U _V	Minus (-) connection, power supply	blue	PIN-2	- U _V
PIN-5	+ I _{OUT}	Current output	gray	PIN-5	(+) I
PIN-2		not assigned	white		
PIN-4		not assigned	black		

4.4.3. Galvanically isolated pulse output

Connection by means of plug-type connector B.

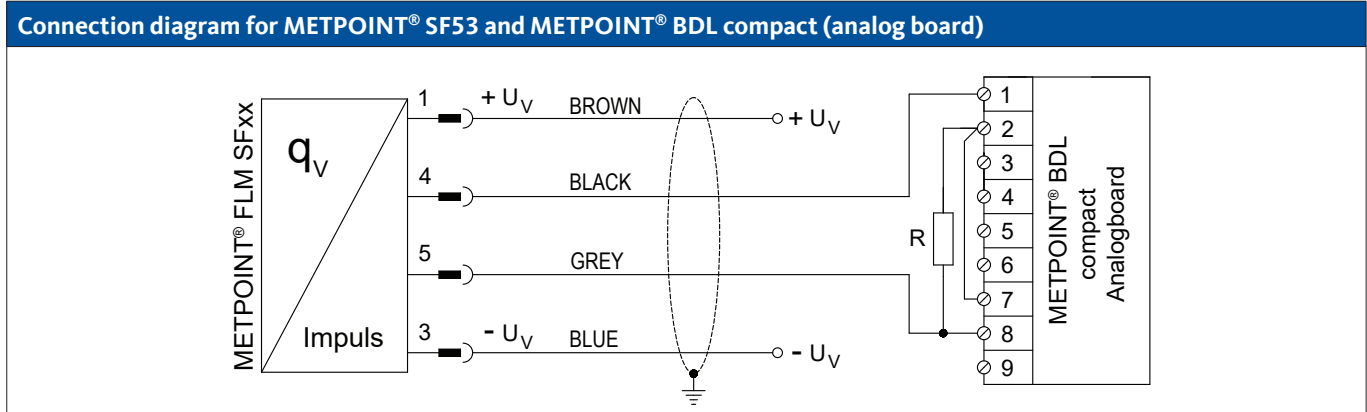

Pin assignment - sensor		Function	Wire color	Pin assignment - BDL compact	
PIN-1	+ U _v	Plus (+) connection, power supply	brown		
PIN-4	Pulse	Pulse	black	PIN-1	+ U _v
PIN-5	Pulse	Pulse	gray	PIN-8	(+) V - PT
PIN-3	- U _v	Minus (-) connection, power supply	blue		
PIN-2		not assigned	white		

4.5. Modbus final termination

If the METPOINT® FLM is used at the end of a Modbus system, final termination is required. The sensor has an installed internal connectible termination. The top 2 grub screws on the housing must be loosened, the cover lifted and the DIP switch (1) set to ON for this purpose. Ensure the housing seal is installed correctly during assembly.

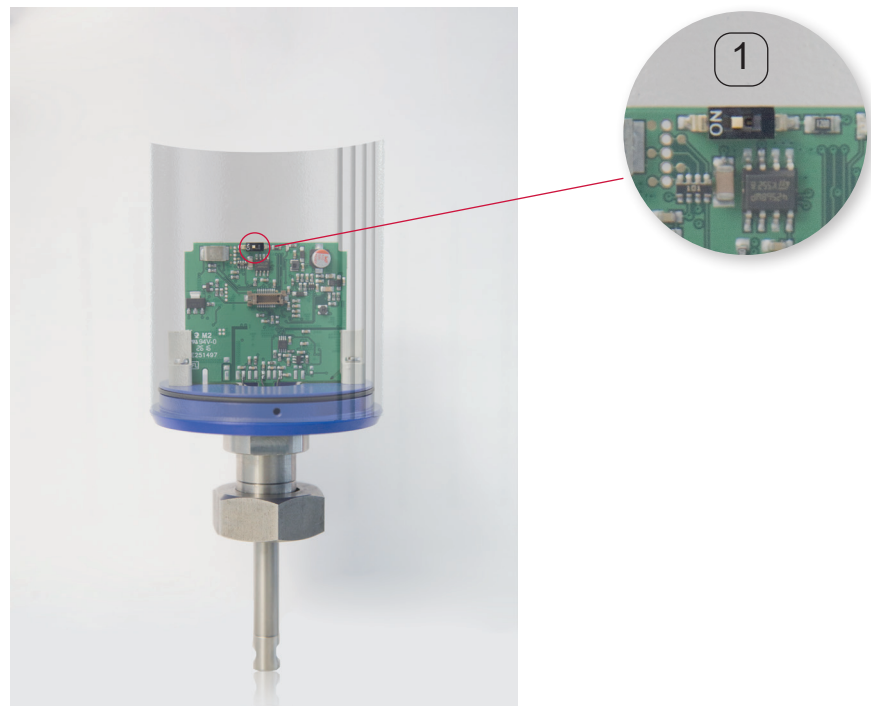

5. Commissioning

To start the METPOINT® FLM, power it and perform the sensor setup as described in "Sensor Setup" on page 28. Slowly pressurize the pipes.

6. Configuration and operation

When the METPOINT® FLM is parted, it is automatically initialized. After this step is completed, main menu is displayed.



The device menus are operated through two capacitive buttons:



>>UP<<



>>ENTER<<

6.1. LED signals during operation

type of gas / status message → Air

HW-Version SW-Version Modbus ID page no.

CAL indicates calibration:

After 15 months, **CAL** shows the upcoming calibration on the display. The display does not influence the measured values. The measurement signal is still output. The time interval can be adjusted as requested by the customer in the manufacturing plant.

Press the >>UP<< button to call up pages 2 - 5.

<p>Compressed Air</p> <p>83.25 fpm</p> <p>24.1 ° F</p> <p>Air</p> <p>HW: 1.02 SW: 1.00 MBID: 127 CAL. 2/4</p>	<p>Average Min Max</p> <p>Flow: cpm AV Min Max</p> <p>395.38 0</p> <p>207.45 870.87</p> <hr/> <p>Total Counter: I</p> <p>78562</p> <p>82.7</p> <p>AV-Time: 1440 minutes 3/4</p>	<p>Average Min Max</p> <p>Velocity: fpm AV Min Max</p> <p>83.25 0</p> <p>55.92 152.87</p> <hr/> <p>Temperature: ° F</p> <p>24.1 21.3</p> <p>23.7 24.6</p> <p>AV-Time: 1440 minutes 4/4</p>
---	--	---

6.2. Setup menu

Press the >>ENTER<< button to call up the setup menu.
The setup menu is password-protected.



Default password (factory settings): 0000 (4 x zero).

If required, change the password by selecting **Setup**→**User Setup**→**Password** .

Press the >>UP<< button to select and to change a value.



Press the >>ENTER<< button to confirm the selection or change.

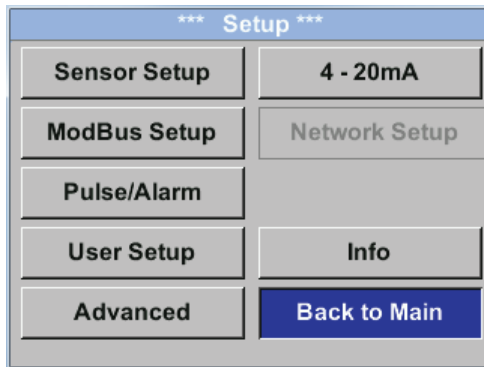

6.3. Sensor Setup

Setup → **Sensor Setup**

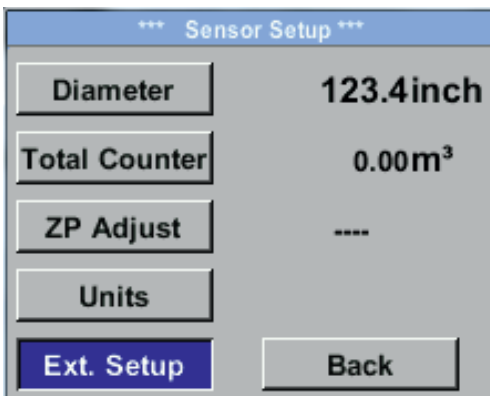

To make a change, select the respective menu option using the >>UP<< button and confirm by pressing the >>ENTER<< button.

6.3.1. Input interior pipe diameter

Setup → Sensor Setup → Diameter

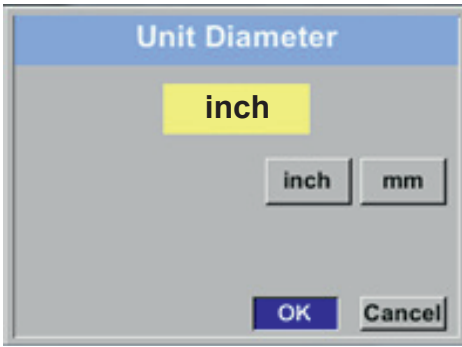

To change the unit, press the >>UP<< button to select the "Unit" field and confirm by pressing the >>ENTER<< button.

Select the desired unit with the >>UP<< button and confirm 2x by pressing the >>ENTER<< button.

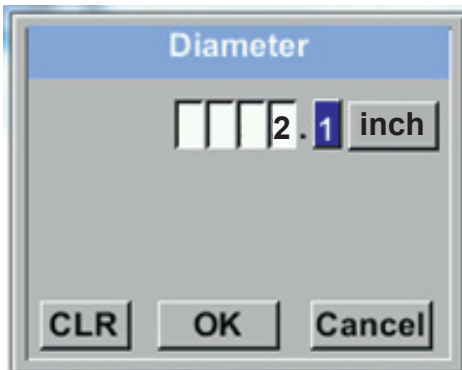

Press the >>UP<< button to select the value to be changed and confirm by pressing the >>ENTER<< button.

Press the >>UP<< button to enter the new value and confirm by pressing the >>ENTER<< button.

6.3.2. Entering / changing consumption counter value

Setup → Sensor Setup → Total Counter

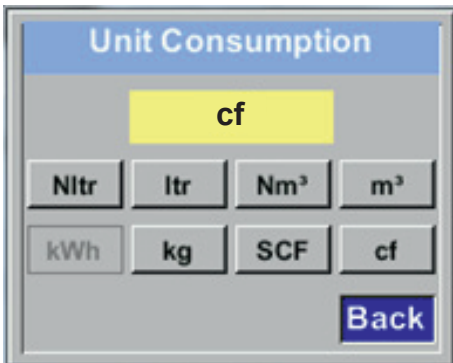

To change the unit, press the >>UP<< button to select the "Unit" field and confirm by pressing the >>ENTER<< button.

Select the desired unit with the >>UP<< button and confirm 2x by pressing the >>ENTER<< button.

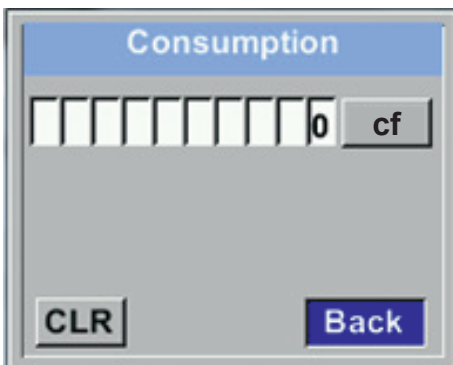

Press the >>UP<< button to select the value to be changed and confirm by pressing the >>ENTER<< button.

Press the >>UP<< button to enter the new value and confirm by pressing the >>ENTER<< button.

NOTICE	Consumption counter value
	When the consumption counter reaches 1,000,000,000 m³, it is automatically reset to 0.

6.3.3. Selecting units for consumption, flow, temperature and pressure

Setup → Sensor Setup → Units

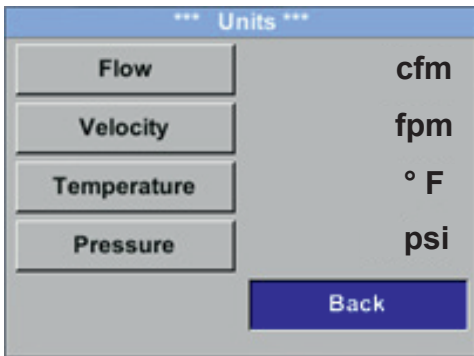

To change the unit, press the >>UP<< button to select the "Unit" field and confirm by pressing the >>ENTER<< button.

If there are more possible units that fit on the screen, press the "<<" button to call up the next screen.

Press the >>UP<< button to select the desired unit and confirm by pressing the >>ENTER<< button 2x.

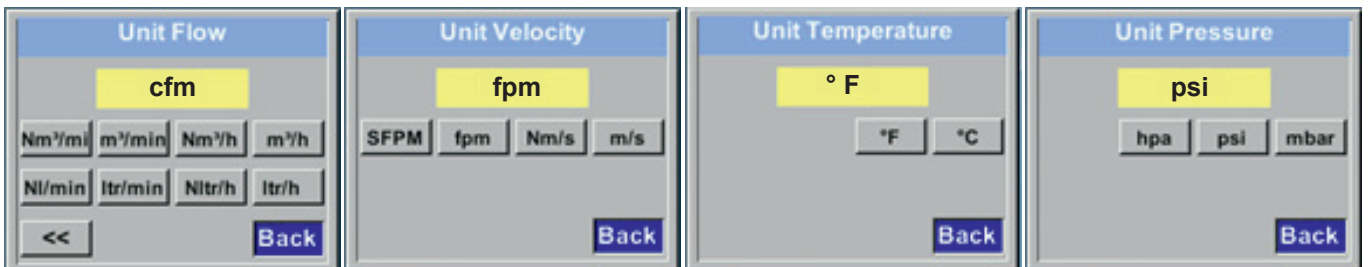

6.3.4. Entering reference conditions

Setup → Sensor Setup → Ext. Setup

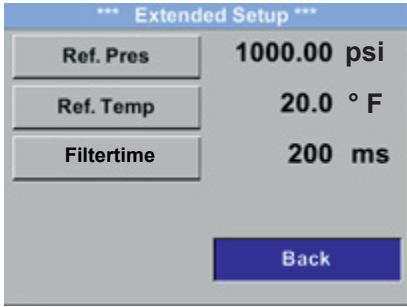

Enter the reference parameter values.

Setup → Sensor Setup → Ext. Setup → Ref.Pres

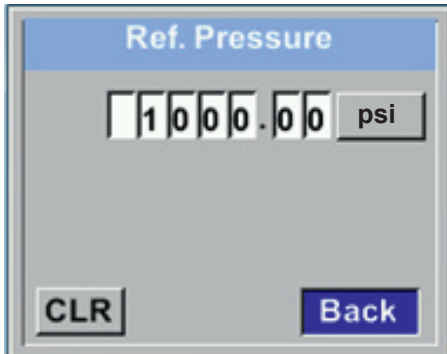

To change the reference conditions, press the >>UP<< button to select the "Unit" field and confirm by pressing the >>ENTER<< button.

Select the desired unit with the >>UP<< button and confirm 2x by pressing the >>ENTER<< button.

Setup → Sensor Setup → Ext. Setup → Ref.Temp

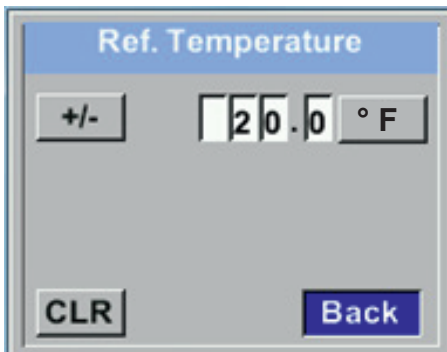

Enter the reference temperature.

Setup → Sensor Setup → Ext. Setup → Filtertime



Under "Filtertime", you can enter an attenuation, provided that a "Filtergrade" is entered.
Possible values: 0 -10000 in [ms].

6.3.5. Setting zero point for low-flow cut-off function

Setup → Sensor Setup → ZP Adjust

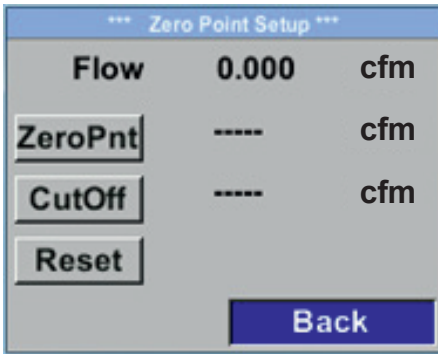

Enter the zero point and the low-flow cut-off point.

Setup → Sensor Setup → ZP Adjust → ZeroPnt

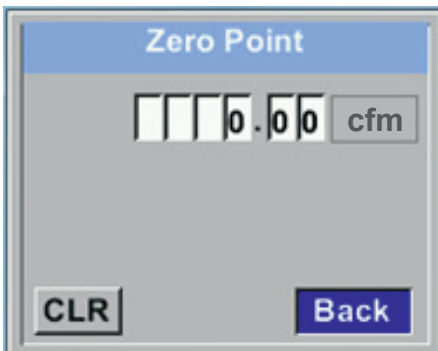

If the installed sensor shows a flow rate of > 0 m³/h even if there is no flow, you can enter a zero point for the characteristic.

To delete the cut-off point, press the "CLR" button.
To return to the previous screen, press the "Back" button.

Setup → Sensor Setup → ZP Adjust → CutOff

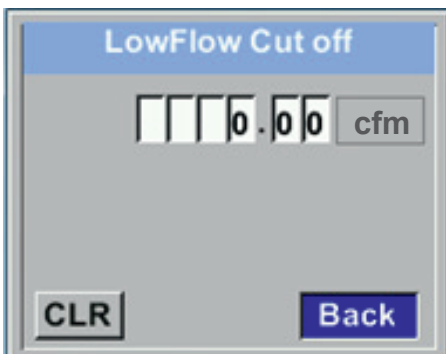

The low-flow cut-off function is used to set consumption rates below the entered low-flow cut-off point to 0 m³/h so that they do not cause the consumption counter value to increase.

To delete the cut-off point, press the "CLR" button.
To return to the previous screen, press the "Back" button.

Setup → Sensor Setup → ZP Adjust → Reset

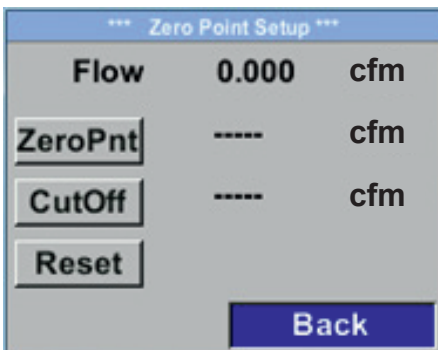

To reset the entered zero point or the low-flow cut-off point, press the "Reset" button.

To return to the previous screen, press the "Back" button.

6.4. Modbus setup

The METPOINT® FLM thermal flow meter is equipped with a RS 485 interface (Modbus RTU). Before starting the sensor, configure the communication parameters

- ModBus ID, baud rate, parity and stop bit

to enable communication with the Modbus master.

Setup → ModBus Setup

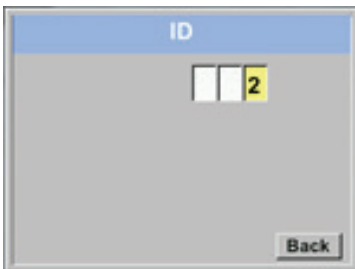
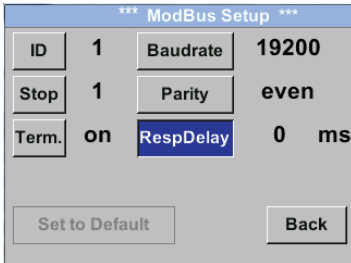

Save the settings by pressing the "Save" button.
To apply the default (factory) settings, press the "Set to Default" button.

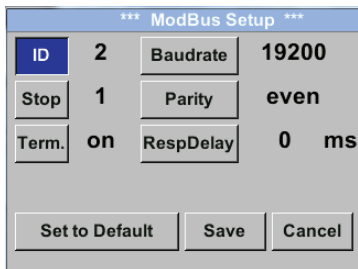

Default (factory) settings:

Modbus ID: 1
Baud rate: 19200
Stop bit: 1
Parity: even

Caution:

If the sensor is the last device in the Modbus system, it must be terminated. For further information, see sec. "4.5. Modbus final termination" on page 26.

6.4.1. Modbus settings (2001 ... 2005)

Modbus Register	Register address	Byte	Data type	Description	Default	Read/write	Unit/comment
2001	2000	2	UInt16	Modbus ID	1	R/W	Modbus ID 1...247
2002	2001	2	UInt16	Baud rate	4	R/W	0 = 1200 1 = 2400 2 = 4800 3 = 9600 4 = 19200 5 = 38400
2003	2002	2	UInt16	Parity	1	R/W	0 = none 1 = even 2 = odd
2004	2003	2	UInt16	Number of stop bits		R/W	0 = 1 stop bits 1 = 2 stop bits
2005	2004	2	UInt16	Word order	0xABCD	R/W	0xABCD = big endian 0xCDAB = middle endian

6.4.2. Values register (1001 ...1500)

Modbus Register	Register Adresse	No. of Byte	Data Type	Description	Default	Read/Write	Holding Register
1101	1100	4	Float	Flow in m ³ /h		R	X
1109	1108	4	Float	Flow in Nm ³ /h		R	X
1117	1116	4	Float	Flow in m ³ /min		R	X
1125	1124	4	Float	Flow in Nm ³ /min		R	X
1133	1132	4	Float	Flow in ltr/h		R	X
1141	1140	4	Float	Flow in Nltr/h		R	X
1149	1148	4	Float	Flow in ltr/min		R	X
1157	1156	4	Float	Flow in Nltr/min		R	X
1165	1164	4	Float	Flow in ltr/s		R	X
1173	1172	4	Float	Flow in Nltr/s		R	X
1181	1180	4	Float	Flow in cfm		R	X
1189	1188	4	Float	Flow in Ncfm		R	X
1197	1196	4	Float	Flow in kg/h		R	X
1205	1204	4	Float	Flow in kg/min		R	X
1213	1212	4	Float	Flow in kg/s		R	X
1221	1220	4	Float	Flow in kW		R	X
1269	1268	4	UInt32	Consumption m ³ before comma	X	R	X
1275	1274	4	UInt32	Consumption Nm ³ before comma	X	R	X
1281	1280	4	UInt32	Consumption ltr before comma	X	R	X
1287	1286	4	UInt32	Consumption Nltr before comma	X	R	X
1293	1292	4	UInt32	Consumption cf before comma	X	R	X
1299	1298	4	UInt32	Consumption Ncf before comma	X	R	X
1305	1304	4	UInt32	Consumption kg before comma	X	R	X
1311	1310	4	UInt32	Consumption kWh before comma	X	R	X
1347	1346	4	Float	Velocity m/s		R	X
1355	1354	4	Float	Velocity Nm/s		R	X
1363	1362	4	Float	Velocity Ft/min		R	X
1371	1370	4	Float	Velocity Nft/min		R	X
1419	1418	4	Float	GasTemp °C		R	X
1427	1426	4	Float	GasTemp °F		R	X

6.5. Pulse / alarm

Setup → Pulse/Alarm

The galvanically isolated pulse output can be used as a pulse or as an alarm output.

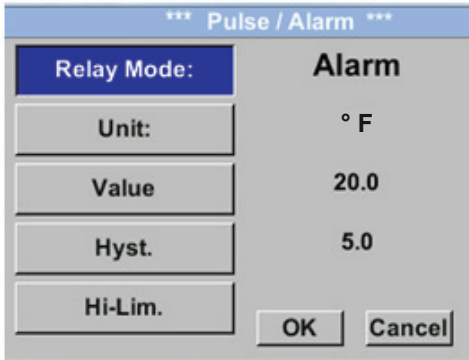

The following units can be selected for the alarm output:

- kg/min, cfm, l/s, m³/h, m/s, °F, °C, kg/s

Press "Value" to enter the alarm value. Press "Hyst." to enter the desired hysteresis.

Hi-Lim: upper limit

Lo-Lim: lower limit

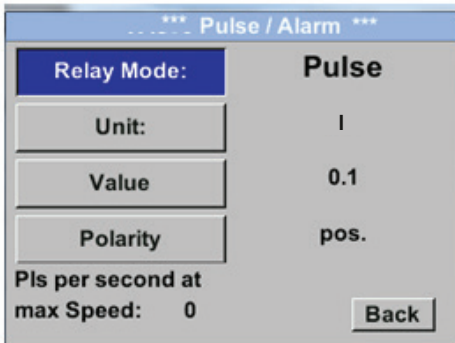

The following units can be selected for pulse output:

- kg, cd, l, m³

Select "Value" to enter the pulse factor (0.1, 1, 10, 100). Select "Polarity" to enter the switching state (plus = 0 → 1, minus = 1 → 0).

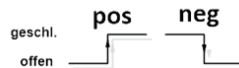

6.5.1. Pulse output

The maximum permissible number of pulses per second is 50. Pulse output is delayed by 1 second.

Pulse factor	[ft ³ /h]	[ft ³ /min]	[gal/min]
0.02642 gal / pulse	635.67	10.59	79.25
0.2642 / pulse	6,356.64	105.94	792.52
3.5315 ft ³ / pulse	635,664.00	10,594.40	79,251.62
35,3147 ft ³ / pulse	6,356,640.01	105,944.00	792,516.16

Table 1: Maximum flow volumes for pulse output

NOTICE	Important information
	Entering pulse valences that do not allow the measurement range end value to be displayed is not allowed. Such entries are discarded and an error message is displayed.

6.6. User Setup

Setup → User Setup

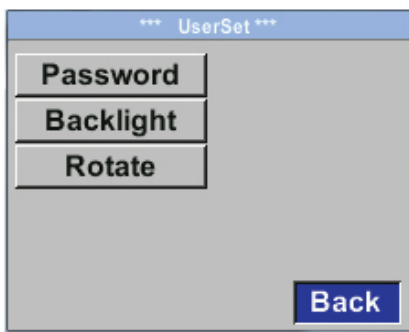

On the user setup screen, you can change the password, rotate the display and adjust its brightness.



To change the password, you must enter the new password twice.

6.7. Advanced

Setup → Advanced

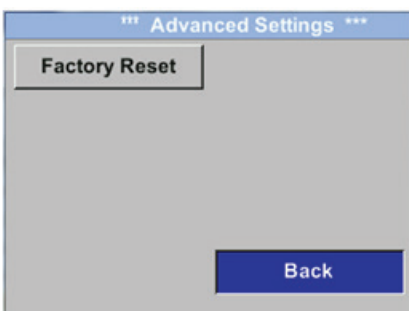

Press the "Factory Reset" button to reset the METPOINT® FLM to its default (factory) settings.

6.8. 4 ... 20 mA

Setup → 4 - 20 mA

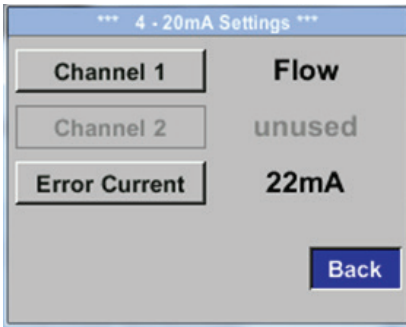

On this screen, you can adjust the settings for the 4 ... 20 mA analog output.

Setup → 4 - 20 mA → Channel 1

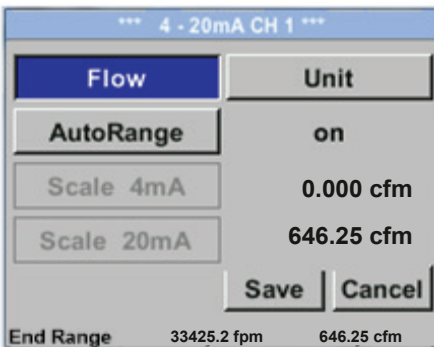

The following measurements can be configured:

- Flow
- Velocity
- Temperature
- unused = deactivate channel

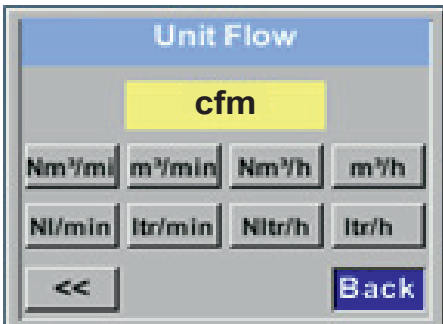

This screenshot shows the adjustable units for volume flow. Press the "<<" button to call up the next screen.

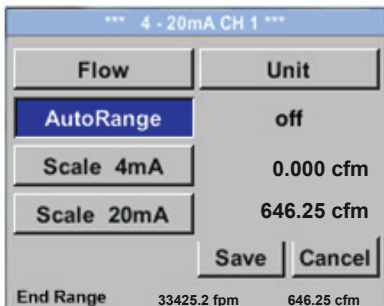

The scaling of the 4 ... 20 mA analog output can be set to automatic ("AutoRange = on") or manual ("AutoRange = off").

With "AutoRange = on", the sensor automatically calculates the valid measuring range and associated reference conditions, based on the set pipe diameter.

Select "Scale 4mA" and "Scale 20mA" to manually configure the scaling of the output (precondition: "AutoRange = off").

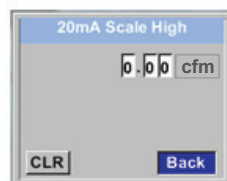
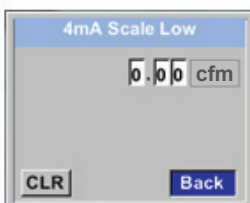

Enter the scale for 4 mA and 20 mA respectively.

Setup → 4 - 20 mA → Error Current

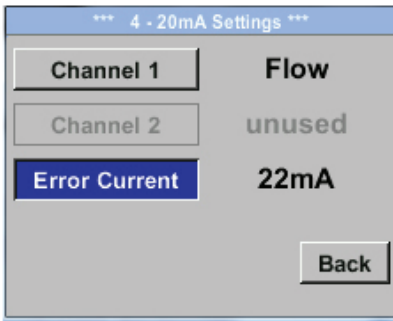

On this screen, you can enter the error signal to be sent by the analog output in the event of a fault.

- 2 mA = sensor fault / system error
- 22 mA = sensor fault / system error
- None = output according to Namur (3.8 mA ... 20.5 mA)
 < 4mA to 3.8 mA = value below measuring range
 > 20 mA to 20.5 mA = value above measuring range

Confirm your entry by pressing the >>ENTER<< button.

6.9. Info

Setup → Info



This screen shows device information.

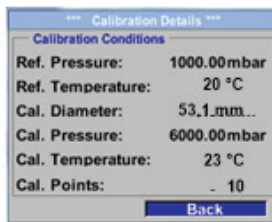

Press "Details" to view the calibration conditions.

6.10. MBus

6.10.1. Default communication settings

Primary address*: 1
 ID: Serial number of sensor
 Baud rate*: 2400
 Medium*: Gas

6.10.2. Transferred values

Value 1 with [Unit]*: Flow [cfm]
 Value 2 with [Unit]*: Consumption [ft³]
 Value 3 with [Unit]*: Velocity [ft/min]
 Value 4 with [Unit]*: Gas temperature [°F]

* these values can be factory-set or changed on request.

7. Spare parts and accessories

The accessories available for the METPOINT® FLM are listed in the table below.

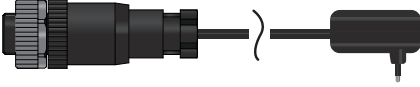
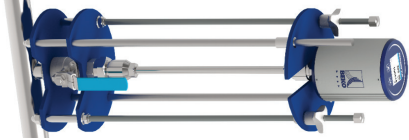
Designation	Picture
Power supply with plug-type connector A → 4032115	
High pressure protection device → 4025892	

8. Maintenance and servicing

Regularly check the sensor head for dirt and clean it, if necessary. Dirt, dust or oil deposits on the sensor element cause incorrect measurements.

We recommend checking the sensor element at least once a year. If the compressed air is heavily contaminated, choose a shorter inspection interval.

9. Cleaning sensor head

To clean the sensor head, immerse it in warm water with a little detergent. Do not clean the sensor with a cloth, sponge, brush or other implement, as any mechanical impact can destroy the sensor. In the event of persistent deposits, return the sensor to the manufacturer for inspection and cleaning.

10. Re-calibration

If the device is not custom-configured, we recommend having it calibrated every 12 months. For calibration, send the METPOINT® FLM to BEKO TECHNOLOGIES GmbH.

11. LED display

There is an LED on the top of the METPOINT® FLM housing, which is used to indicate the calibration time. The light flashes after 15 months to indicate there is an upcoming re-calibration. The flashing LED does not influence measured values. The measurement signal is still output.

The time interval can be adjusted as requested by the customer in the manufacturing plant.

12. Declaration of Conformity

BEKO TECHNOLOGIES GMBH
 Im Taubental 7
 41468 Neuss, GERMANY
 Tel: +49 2131 988-0
 www.beko-technologies.com



EU-Konformitätserklärung

Wir erklären hiermit, dass die nachfolgend bezeichneten Produkte den Anforderungen der einschlägigen Richtlinien und technischen Normen entsprechen. Diese Erklärung bezieht sich nur auf die Produkte in dem Zustand, in dem sie von uns in Verkehr gebracht wurden. Nicht vom Hersteller angebrachte Teile und/oder nachträglich vorgenommene Eingriffe bleiben unberücksichtigt.

Produktbezeichnung:	METPOINT® FLM
Typ:	SF53 und SF13
Spannungsversorgung:	18 ... 36 VDC
IP-Schutzart	IP65
Max. Betriebsdruck:	16 bar(g)
Min. / Max. Betriebstemperatur:	-30°C / +80°C
Datenblatt:	DB_FLM-0916-FP-A
Produktbeschreibung und Funktion:	Thermischer Massen-Durchflussmesser für Druckluft

Druckgeräte-Richtlinie 2014/68/EU

Die Produkte fallen in keine Druckgeräte-kategorie und sind gemäß Artikel 4 Absatz 3 in Übereinstimmung mit der in den Mitgliedstaaten geltenden guten Ingenieurspraxis ausgelegt und werden dieser entsprechend hergestellt.

EMV-Richtlinie 2014/30/EU

Angewandte harmonisierte Normen: EN 61326-1:2013, EN 61326-2-3:2013

ROHS II-Richtlinie 2011/65/EU

Die Vorschriften der Richtlinie 2011/65/EU zur Beschränkung der Verwendung bestimmter gefährlicher Stoffe in Elektro- und Elektronikgeräten werden erfüllt.

Die Produkte sind mit dem abgebildeten Zeichen gekennzeichnet:



Die alleinige Verantwortung für die Ausstellung dieser Konformitätserklärung trägt der Hersteller.

Neuss, 27.03.2017

Unterzeichnet für und im Namen von:

BEKO TECHNOLOGIES GMBH

i.V. Christian Riedel

Leiter Qualitätsmanagement International

CE_FLM-896-0317-FP-A

BEKO TECHNOLOGIES GMBH
 Im Taubental 7
 41468 Neuss, GERMANY
 Phone: +49 2131 988-0
 www.beko-technologies.com



EU Declaration of Conformity

We hereby declare that the products named below comply with the stipulations of the relevant directives and technical standards. This declaration only refers to products in the condition in which they have been placed into circulation. Parts which have not been installed by the manufacturer and/or modifications which have been implemented subsequently remain unconsidered.

Product designation:	METPOINT® FLM
Types:	SF53 and SF13
Power supply:	18 ... 36 VDC
IP protection rating	IP65
Max. operating pressure:	16 bar(g)
Min./max. operating temperature:	-22°F (-30°C) / +176°F (80°C)
Data sheet:	DB_FLM-0916-FP-A
Product description and function:	Thermal flow meter for compressed air

Pressure Equipment Directive 2014/68/EU

The products are not classified in any pressure equipment category. In accordance to article 4, section 3, they have been designed and manufactured according to sound engineering practice as applicable in the EU member states.

EMC Directive 2014/30/EU

Applied harmonized standards: EN 61326-1:2013, EN 61326-2-3:2013

RoHS II Directive 2011/65/EU

The products meet the requirements laid down in European Directive 2011/65/EU concerning the restriction of the use of certain hazardous substances in electrical and electronic devices.

The products bear the CE Mark:



This Declaration of Conformity has been issued by the manufacturer.

Neuss, 25/10/2016

Signed on behalf of:
BEKO TECHNOLOGIES GMBH

ppa Christian Riedel
 Head of International Quality Management

CE_FLM-896-0916-FP-A

BEKO TECHNOLOGIES GmbH

Im Taubental 7
 D - 41468 Neuss
 Tel. +49 2131 988 0
 Fax +49 2131 988 900
 info@beko-technologies.com
 service-eu@beko-technologies.com

DE**BEKO TECHNOLOGIES LTD.**

Unit 11-12 Moons Park
 Burnt Meadow Road
 North Moons Moat
 Redditch, Worcs, B98 9PA
 Tel. +44 1527 575 778
 info@beko-technologies.co.uk

GB**BEKO TECHNOLOGIES S.à.r.l.**

Zone Industrielle
 1 Rue des Frères Rémy
 F - 57200 Sarreguemines
 Tél. +33 387 283 800
 info@beko-technologies.fr
 service@beko-technologies.fr

FR**BEKO TECHNOLOGIES B.V.**

Veenen 12
 NL - 4703 RB Roosendaal
 Tel. +31 165 320 300
 benelux@beko-technologies.com
 service-bnl@beko-technologies.com

NL**BEKO TECHNOLOGIES (Shanghai) Co. Ltd.**

Rm.715 Building C, VANTONE Center
 No.333 Suhong Rd.Minhang District
 201106 Shanghai
 Tel. +86 (21) 50815885
 info.cn@beko-technologies.cn
 service1@beko.cn

CN**BEKO TECHNOLOGIES s.r.o.**

Na Pankraci 58
 CZ - 140 00 Praha 4
 Tel. +420 24 14 14 717 /
 +420 24 14 09 333
 info@beko-technologies.cz

CZ**BEKO Tecnológica España S.L.**

Torruella i Urpina 37-42, nave 6
 E - 08758 Cervelló
 Tel. +34 93 632 76 68
 Mobil +34 610 780 639
 info.es@beko-technologies.es

ES**BEKO TECHNOLOGIES LIMITED**

Room 2608B, Skyline Tower,
 No. 39 Wang Kwong Road
 Kwloon Bay Kwloon, Hong Kong
 Tel. +852 2321 0192
 Raymond.Low@beko-technologies.com

HK**BEKO TECHNOLOGIES INDIA Pvt. Ltd.**

Plot No.43/1 CIEEP Gandhi Nagar
 Balanagar Hyderabad
 IN - 500 037
 Tel. +91 40 23080275 /
 +91 40 23081107
 Madhusudan.Masur@bekoindia.com
 service@bekoindia.com

IN**BEKO TECHNOLOGIES S.r.l**

Via Peano 86/88
 I - 10040 Leinì (TO)
 Tel. +39 011 4500 576
 Fax +39 0114 500 578
 info.it@beko-technologies.com
 service.it@beko-technologies.com

IT**BEKO TECHNOLOGIES K.K**

KEIHIN THINK Building 8 Floor
 1-1 Minamiwatarida-machi
 Kawasaki-ku, Kawasaki-shi
 JP - 210-0855
 Tel. +81 44 328 76 01
 info@beko-technologies.jp

JP**BEKO TECHNOLOGIES Sp. z o.o.**

ul. Pańska 73
 PL - 00-834 Warszawa
 Tel. +48 22 314 75 40
 info.pl@beko-technologies.pl

PL**BEKO TECHNOLOGIES S. de R.L. de C.**

BEKO Technologies, S de R.L. de C.V.
 Blvd. Vito Alessio Robles 4602 Bodega 10
 Zona Industrial
 Saltillo, Coahuila, 25107
 Mexico
 Tel. +52(844) 218-1979
 informacion@beko-technologies.com

MX**BEKO TECHNOLOGIES CORP.**

900 Great Southwest Pkwy SW
 US - Atlanta, GA 30336
 Tel. +1 404 924-6900
 Fax +1 (404) 629-6666
 beko@bekousa.com

US